

Architectural Entry Door Pulls

Elmes Entry Pull Range Manufactured by Union Corp. of Japan

Inspirational.....



Entry Door pulls for any designer decor: Over 200 models to select from, ranging in size from 400 mm through to 3000mm with a choice of styles, designs and finishes including Brass, Stainless Steel, Aluminium, Timber, Bronze Wrought Iron & Glass just to name a few, you are guaranteed to find something truly special.



Bellevue Imports Pty Ltd
Architecturally Designed for the Inspired

Delivering the Highest Quality & Latest in European Designed & Manufactured Architectural Hardware for nearly 30 Years

Call 1300 369 395, www.BellevueImports.com.au or email info@BellevueImports.com.au for more information



Model G2950 - See page 59 for details







ENTRY DOOR PULLS



Category

- 4 Model Index
- 5 Elmes & Bellevue History
- 6 General Information
- 6 Material & Finish
- 20 New Models
- 40 Featured Models
- 58 Small Size
- 78 Medium Size
- 108 Timber Models
- 140 Nambu Iron Models
- 144 Wrought Iron Models
- 161 Semi-Long Size
- 169 Large Size

Model Index

 New Models	 Medium Entry Pulls
 Featured Models	 Semi - Long Entry Pulls
 Small Entry Pulls	 Large Entry Pulls

Item	Page	Item	Page	Item	Page	Item	Page	Item	Page	Item	Page
BEP01	176	G2607	149	T51	172	T1520	77	T2850	173	T5570	69
BEP02	176	G2608	149	T52	105	T1550	41	T2860	80	T5656	91
BEP03	176	G2616	64	T55	172	T1550	85	T2864	80	T5701	71
BEP04	177	G2618	143	T61	172	T1570	63	T2870	123	T5785	165
BEP05	177	G2619	63	T62	175	T1780	95	T2871	123	T5789	165
BEP06	177	G2629	127	T78	138	T2002	68	T2880	79	T5955	93
BEP07	178	G2681	174	T215	43	T2033	165	T2888	162	T6010	100
BEP17	179	G2690	89	T220	133	T2041	155	T2890	113	T6400	67
G52	106	G2733	139	T330	88	T2043	153	T2920	51	T6500	89
G52	129	G2734	84	T380	88	T2100	64	T2925	53	T6510	94
G78	133	G2746	45	T530	128	T2112	83	T2940	61	T6515	94
G330	88	G2750	42	T561	171	T2113	164	T2955	57	T6516	75
G345	65	G2750	76	T573	107	T2151	150	T2970	55	T7036	166
G380	88	G2750	111	T590	133	T2208	138	T2971	55	T7067	67
G530	128	G2751	163	T610	168	T2212	150	T2980	47	T7070	161
G561	171	G2759	132	T617	167	T2240	92	T3008	92	T7110	125
G573	107	G2800	117	T626	129	T2290	21	T3026	91	T7210	96
G590	133	G2850	173	T665	87	T2300	66	T3048	66	T7250	154
G666	86	G2888	162	T666	86	T2302	145	T3053	95	T7800	70
G685	82	G2890	113	T670	89	T2303	145	T3067	102	T8038	98
G690	87	G2920	51	T685	81	T2304	99	T3077	83	T8050	42
G720	104	G2925	53	T690	87	T2306	98	T3087	165	T8170	155
G720	129	G2950	59	T720	103	T2309	73	T3103	154	T8630	83
G736	126	G2995	49	T720	127	T2313	128	T3105	96	T8650	169
G777	109	G3075	102	T720	138	T2318	139	T3109	155	T8650-O	169
G811	152	G3078	83	T727	150	T2412	134	T3278	91	T8800	68
G822	154	G3084	90	T736	126	T2516	91	T3305	166	T8901	146
G860	152	G3085	90	T811	152	T2523	147	T3321	136	T8904	146
G1101	23	G3086	90	T812	153	T2524	147	T3341	65	T8908	147
G1103	35	G3321	137	T836	155	T2607	149	T3350	164	T8909	147
G1104	37	G4260	71	T860	152	T2608	149	T3351	164	T9010	86
G1105	27	G5080	43	T924	153	T2615	64	T3361	161	T9080	163
G1106	27	G5270	97	T987	160	T2618	141	T3362	161	T9700	164
G1109	31	G5400	131	T995	151	T2619	142	T3363	131	T9933	92
G1203	39	G5701	71	T1005	157	T2629	127	T3384	160	T9960	149
G2054	102	G5955	93	T1024	151	T2638	166	T3385	160	T9961	149
G2100	64	G6000	68	T1028	159	T2719	63	T3702	70	T9962	145
G2236	141	G6400	67	T1029	157	T2719	142	T3970	154	T9972	153
G2300	66	G7067	67	T1030	159	T2733	139	T4260	71	UL551	90
G2302	145	G7110	125	T1032	157	T2734	84	T5120	102	UL728	143
G2313	128	G7800	70	T1033	159	T2740	119	T5210R	69	UL729	63
G2327	85	G8800	68	T1051	159	T2741	119	T5210S	69	UL729	143
G2401	73	G12300	77	T1101	25	T2745	45	T5270	97		
G2404	65	G12500	77	T1107	29	T2752	175	T5350	96		
G2412	135	H2800	115	T1109	31	T2759	132	T5400	131		
G2508	99	H2860	121	T1205	33	T2810	75	T5500	98		

1983.....

In 1983, while renovating his own home, Aron Midler (founder of Bellevue Imports) experienced something I am sure was not uncommon at the time: the inability to find high quality and uniquely designed architectural furniture. Frustrated with what he did find, Aron spoke to a number of leading Architects and Interior Designers who all agreed that the Australian market could benefit significantly, if products available overseas were available locally.

Recognising the gap in the Australian market place for these types of uniquely designed products, he took the opportunity to work with the leading manufacturers of kitchen and cabinet handles: Cosma of Italy, Didheya of Spain, Omp Porro of Italy, Siro of Austria, as well as many others (from all over the world) to form Bellevue Imports.

Today.....

For nearly 30 years, Bellevue Imports has been providing Australia and New Zealand with the best and most extensive range of architectural hardware and accessories available, all of which are recognised as world class in quality, design and craftsmanship.

Since Bellevue's inception, Aron's commitment in bringing to Australia the newest and most comprehensive range of architectural products has not wavered. Bellevue has supplied countless projects, from kitchen renovations, cabinet makers, new homes and residential renovations to apartments, large commercial projects & resorts. Bellevue's products are available Australia & New Zealand wide from various resellers or on a direct basis (based on location). For your nearest reseller location, please visit our web site at www.bellevueimports.com.au

Bellevue is proud to be a leader in the architectural products market place, and will continue its tradition to provide products that are unique, visually distinctive, affordable and just as importantly, stocked locally, in quantity.

Inspiration.....

For as long as we can remember, we have been striving to create, design and build. Our conscious effort to better ourselves and willingness to take risks, has separated us from the rest.

“We look, we touch, we consider and we are inspired”

For nearly 30 years, Bellevue has also been inspired...Inspired to source and stock from all over the world, products that create visual attraction and differentiation without compromising quality, design or affordability.

Today Bellevue has represented nothing but the best in architecturally inspired hardware and accessories. The relationship between design and form, form and function, aesthetics and practicality are all symbiotic.

A key distinction of the Bellevue name is the significant number of interpretations of the “design” concept. Consistently challenging the traditional, with new and practical ideas that inspire.

Form can be unique, a challenge to design and create. From a coat hook to a shelf bracket to a door handle, all inspired designs, their materialization and transformation into a functional, practical fitting is evident in the number of designs which exist in the Bellevue range.

“Inspiration is true design.....embrace it”

Elmes of Japan

Founded in 1946 in Japan, Elmes has over 60 years of experience in the design, creation and manufacturing of Entry Door Pulls. Elmes is considered to be the leader in the field of entry door pulls, due to the vast array of designs and the quality and craftsmanship of the products produced.

One of the many unique and valued attributes Elmes brings to the entry door pull market is a philosophy of responding to the needs of modern space with great diversity, without sacrificing craftsmanship.

Because the door handle is the part of the room that people encounter first, and each room is different in design and environment, each Elmes entry door pull is designed to be architecturally complete in itself, with the understanding that it is from there that coordination of the entire space originates.

The diversity of the Elmes range and its aesthetic attributes are simply, second to none.

Today there is a substantial range of products with a modern taste, such as designs featuring the distinctive beauty of straight lines and elegant curves and special designs with triangular and teardrop-shaped grips. In addition, new products that respond to the needs of the space debut as well, such as 2400mm and 3000mm long handles anchored at two points. Enjoy the beautiful forms produced by our craftsmanship and the comfort felt at the moment of touch with this rich line up of Elmes products.

The general idea of design, which passed through aspects of various periods and became confused, is given a fresh start from an arts and crafts group called Elmes, which conveys the warmth of the creator and Japanese traditional sense of beauty while being impacted by Western modern design.

Bellevue is proud to be the exclusive distributor of Elmes of Japan's products in Australia and New Zealand. We look forward to supplying you your hardware needs with our exquisite range of door handles.

Specification Codes

Always a tricky one. To make life easier, we have simplified the coding of the range down to (4) basic components.

Lets look at the code *T8650-2025-PS* and break it down.

1. *T or G* = Type of door the pull is applicable for
 - T** - Mainly used for framed doors and flush door (some T models can be installed on glass) .
 - G** - Mainly used for glass door (directly on glass) and flush door.
2. *8650* = Model number of handle
3. *2025mm* = overall handle length
4. *PS* = Finish of handle

Cleaning and Maintenance

All entry pulls should be cleaned at regular intervals with a soft grit free cloth & using only clean warm water, then wiped dry. Warning: Do not use a scouring pad of any type as this will cause excessive wear on the finish. Stainless steel models require periodic cleaning with especially formulated stainless steel cleaning products designed for stainless surfaces.

Supply & Fixings

Unless stated otherwise, all handles are supplied as back-to-back sets with fixings. Entry pulls come complete with back to

back or single side fix for timber, aluminium, metal or glass doors. T models are supplied with fixings to suit 40mm or less thick door. G models are supplied with fixings to suit 14mm or less toughened glass door. Fixings to suite non-standard door thickness can be supplied if requested at time of order.

Base Materials Used (Example Only)

- Stainless Steel
- Aluminium
- Brass
- Bronze
- Wrought Iron
- Japanese Cast Iron (Nambu-Tetsu)
- Uniwood (Antibacterial Compressed Wood)
- Maple Timber
- Plywood Unimin
- Unimin (Melamine Resin)

Available Finishes (Example Only)

- Polished Brass Lacquer
- Polished Stainless Steel
- Hairline Stainless Steel (Fine Grain Brushed Steel)
- Anodized Silver & Anodized Black
- Melamine Black & Melamine White
- Umber (Anodaization Aluminium)
- Oxidized Dark Bronze
- Maple Clear Coating
- Baked Finish Charcoal Grey
- Ceramic Baked Rose Red
- Baked Finish Red Rust Colour

Disclaimer

Whilst every effort has been made to ensure that the information contained in this catalogue is accurate at the time of publication, it is recommended that you consult Bellevue Imports Pty Ltd prior to placing any order to ascertain current information on specific products.

Bellevue Imports Pty Ltd will not be liable for any injury, loss or damage whatsoever, arising from any errors or omissions in the information contained in this book or arising from the use or application of the information contained herein. Bellevue Imports Pty Ltd policy is one of continuous product improvement; as a result changes to product specifications may be made without incurring liability.



Model T2618 - See page 141 for details

For more information Phone 1300 369 395 Email info@BellevueImports.com.au Web www.BellevueImports.com 7



Design & Creativity, Limited Only by Ones Imagination.

Imagined in ones mind, inscribed on paper, materialized in Brass: Custom designs of all shapes, sizes, materials and finishes. If you can visualize a design, Elmes can make it.

Talk to us about the realization of your imagination.

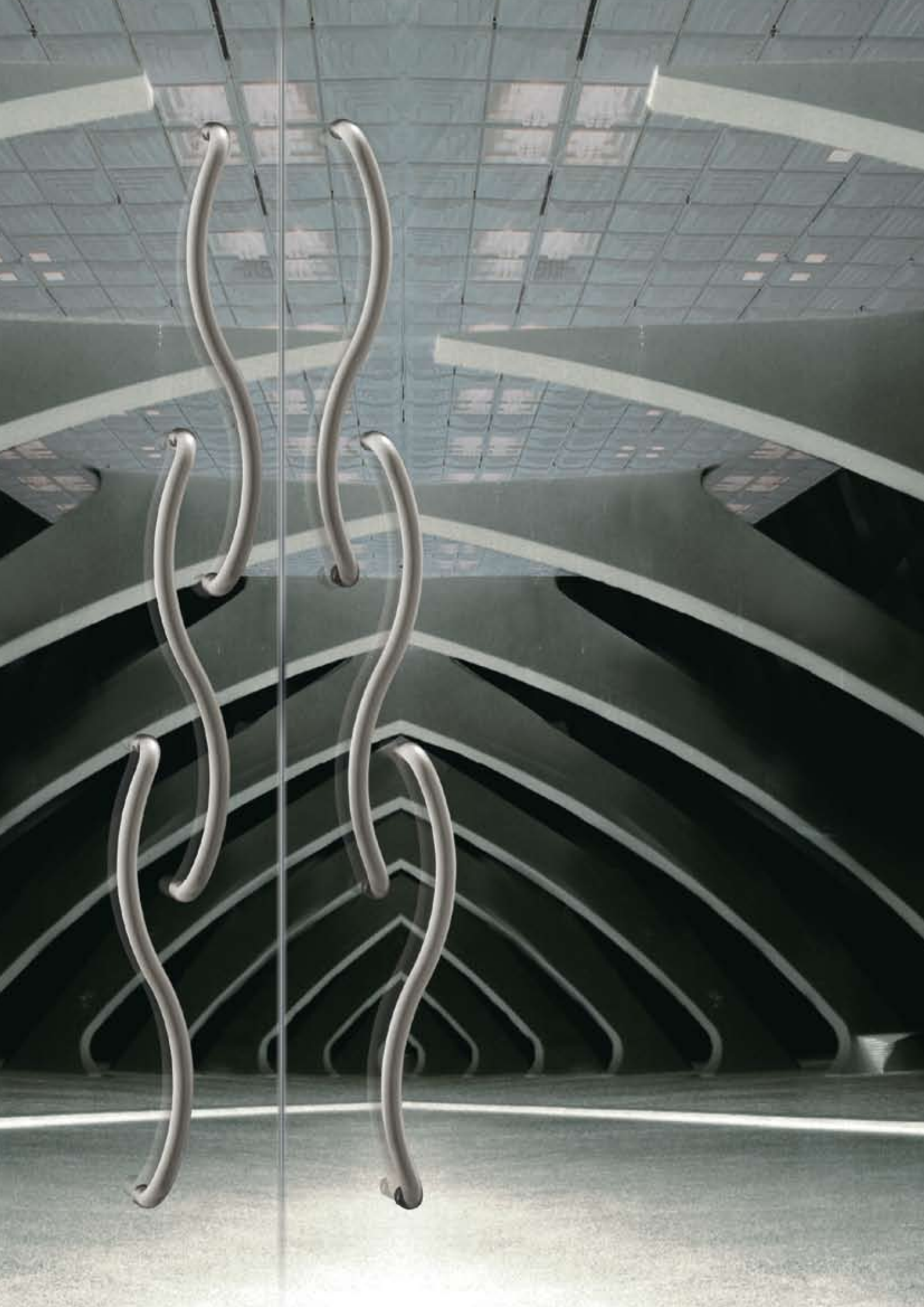



Model T2880 - See page 79 for details



Model T2759 - See page 132 for details



Model G6000 - See page 68 for details

12 For more information Phone 1300 369 395 Email info@BellevueImports.com.au Web www.BellevueImports.com



Model T2524 - See page 147 for details



Model T8908 - See page 147 for details

14 For more information Phone 1300 369 395 Email info@BellevueImports.com.au Web www.BellevueImports.com

fiori
GIOIA
FLOWER DESIGN



Model T1780 - See page 95 for details



Model T2752 - See page 175 for details

16 For more information Phone 1300 369 395 Email info@BellevueImports.com.au Web www.BellevueImports.com



Model T2733 - See page 139 for details



Model T1005 - See page 157 for details

18 For more information Phone 1300 369 395 Email info@BellevueImports.com.au Web www.BellevueImports.com

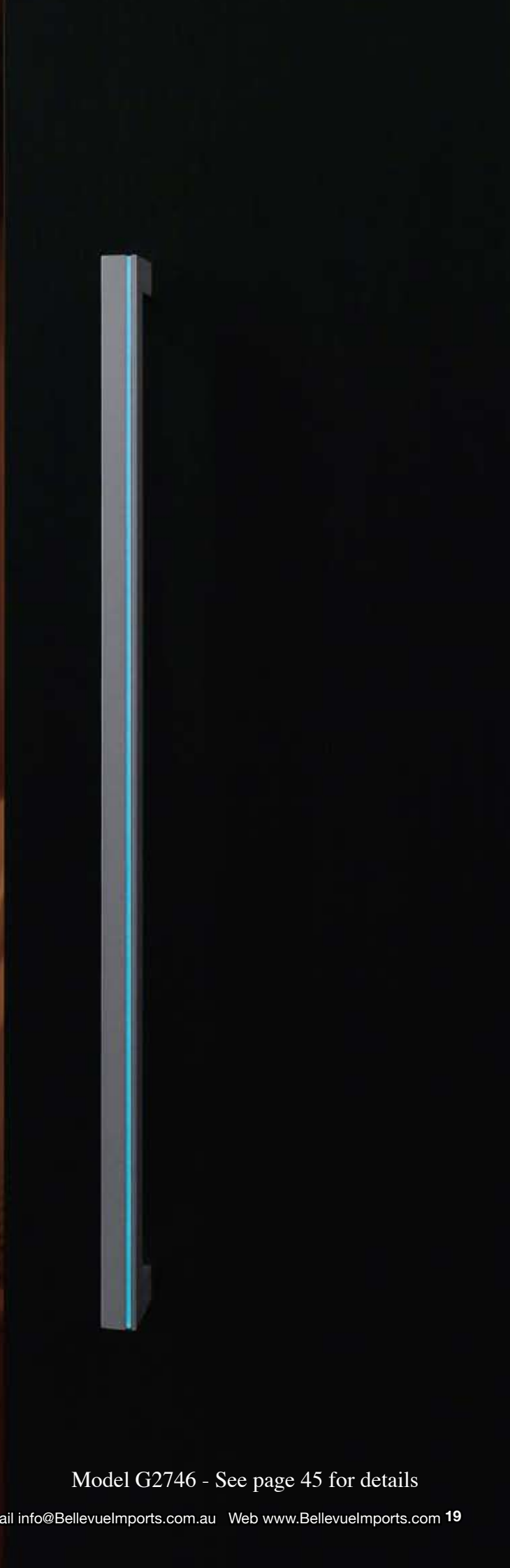

Model G2746 - See page 45 for details



A crisp linear beauty from three interwoven square pipes.

A door handle designed with skillfully interwoven straight lines. A crisp presence, in harmony, with a stylish space. The line of mirror imbedded in the centre is an accent that tones the impression of the space.



T2990

Base Material
Stainless Steel

Available Finish
Hairline Stainless + Polished
Stainless Steel (HP)

Australian Handing
Australian Left Hand (L)
Australian Right Hand (R)

Available Sizes (mm)
Length 598, Centres 480

Fixing Holes Sizes
Door 8mm, Glass 12mm

Specification Code
T2990 - 598 - HP - L
T2990 - 598 - HP - R

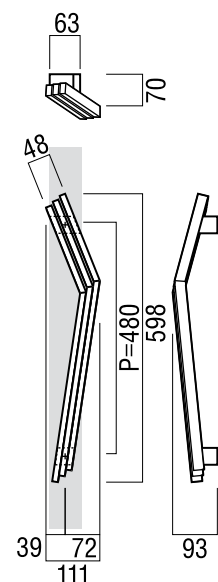





G1101

Base Material
Stainless Steel & Uni-Wood
(Antibacterial Compressed Wood)

Available Finish
Stainless Steel Hairline &
Stainless Steel Polished (S)
Uni-Wood White & Stainless Steel
Polished (W)
Uni-Wood Pale Scotch Colour &
Stainless Steel Hairline (PS)

Available Sizes (mm)
Length 250, Centres 230

Fixing Holes Sizes
Door 8mm, Glass 12mm

Specification Code
G1101 - 250 - finish

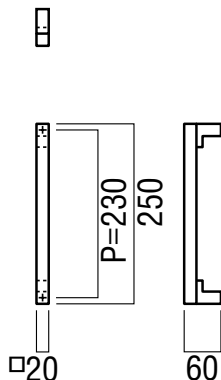

G1101

Base Material
Stainless Steel & Uni-Wood
(Antibacterial Compressed Wood)

Available Finish
Stainless Steel Hairline &
Stainless Steel Polished (S)
Uni-Wood White & Stainless Steel
Polished (W)
Uni-Wood Pale Scotch Colour &
Stainless Steel Hairline (PS)

Available Sizes (mm)
Length 600, Centres 580

Fixing Holes Sizes
Door 8mm, Glass 12mm

Specification Code
G1101 - 600 - finish

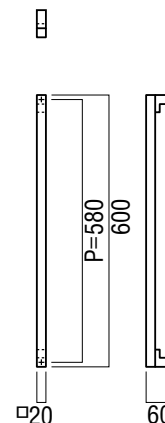





T1101

Base Material
Stainless Steel

Available Finish

Stainless Steel Hairline &
Stainless Steel Polished (S)
Uni-Wood White & Stainless Steel
Polished (W)
Uni-Wood Pale Scotch Colour &
Stainless Steel Hairline (PS)

Available Sizes (mm)

Length 250, Centres 230

Fixing Holes Sizes

Door 8mm, Glass 12mm

Specification Code

T1101 - 250 - finish

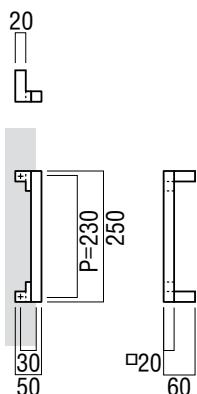

T1101

Base Material
Stainless Steel

Available Finish

Stainless Steel Hairline &
Stainless Steel Polished (S)
Uni-Wood White & Stainless Steel
Polished (W)
Uni-Wood Pale Scotch Colour &
Stainless Steel Hairline (PS)

Available Sizes (mm)

Length 600, Centres 580

Fixing Holes Sizes

Door 8mm, Glass 12mm

Specification Code

T1101 - 600 - finish

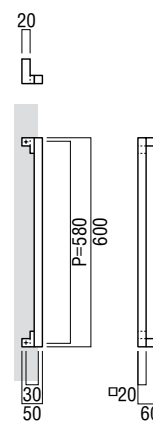





G1105

Base Material
Stainless Steel & Titanium

Available Finish
Stainless Steel Hairline & Polished (S)
Stainless Steel Hairline & Polished, Titanium Hard Coating Black (B)
Stainless Steel Hairline & Polished, Titanium Hard Coating Gold (G)

Available Sizes (mm)
Length 700, Centres 640

Fixing Holes Sizes
Door 8mm, Glass 12mm

Specification Code
G1105 - 700 - finish

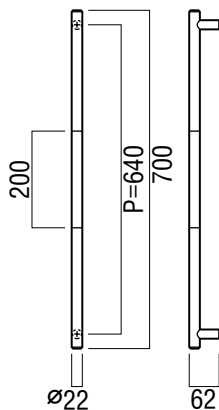

G1106

Base Material
Stainless Steel & Titanium

Available Finish
Stainless Steel Hairline & Polished (S)
Stainless Steel Hairline & Polished, Titanium Hard Coating Black (B)
Stainless Steel Hairline & Polished, Titanium Hard Coating Gold (G)

Available Sizes (mm)
Length 700, Centres 640

Fixing Holes Sizes
Door 8mm, Glass 12mm

Specification Code
G1106 - 700 - finish

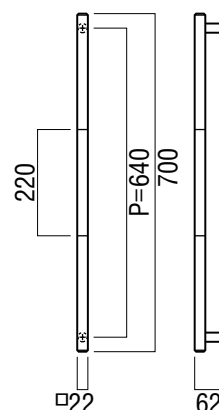
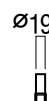



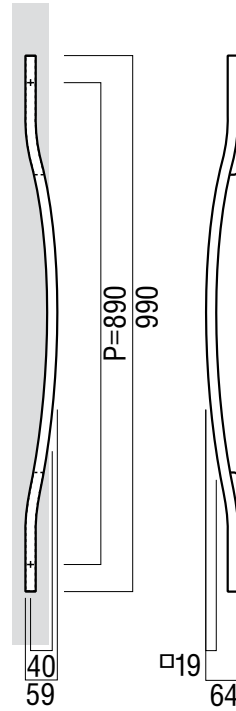

T1107

Base Material
Stainless Steel & Elastomer

Available Finish
Stainless Steel Hairline &
Elastomer Black (B)

Available Sizes (mm)
Length 990, Centres 890

Fixing Holes Sizes
Door 8mm, Glass 12mm

Specification Code
T1107 - 990 - B

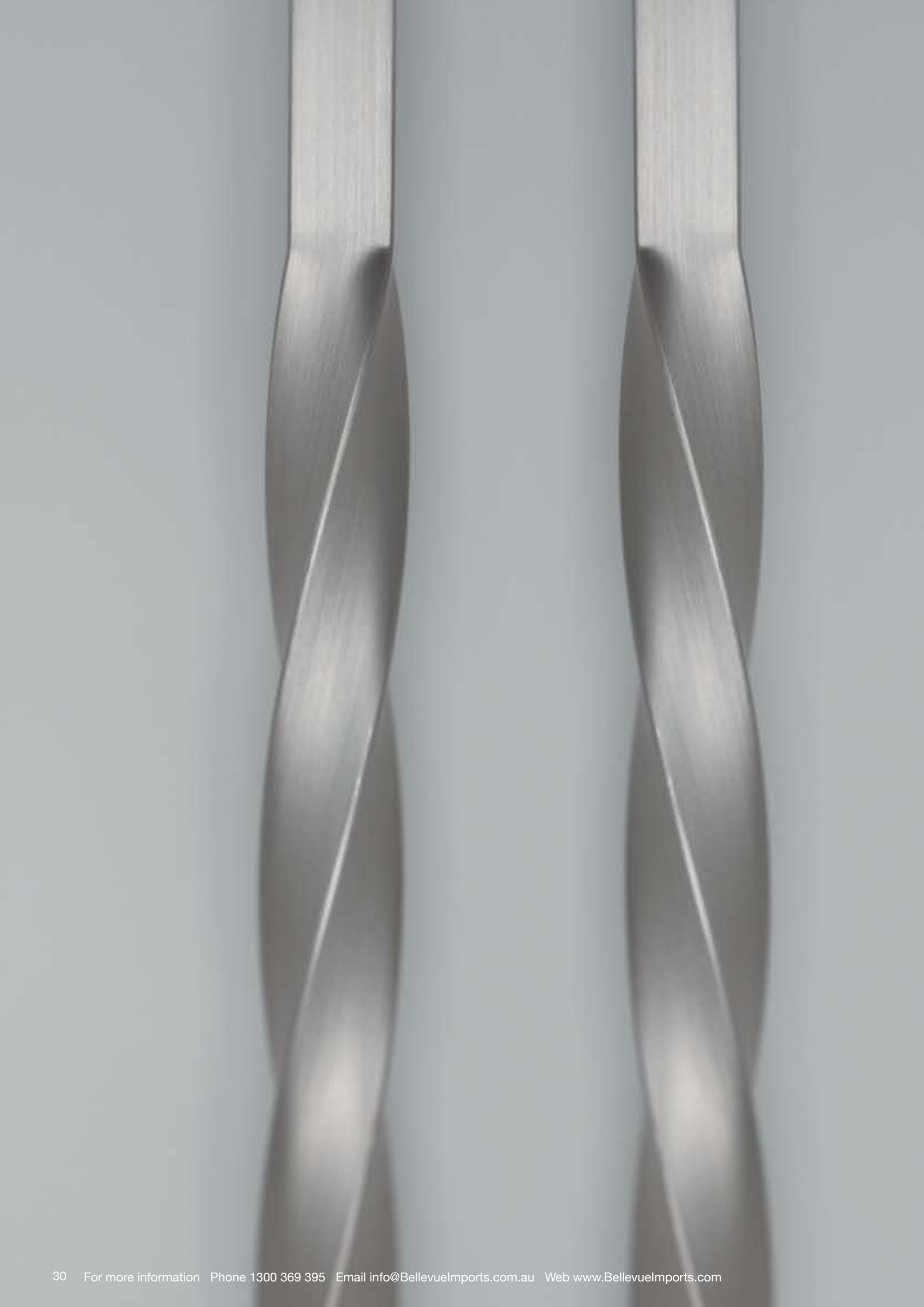

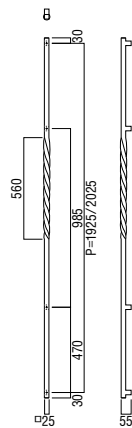

G1109

Base Material
Stainless Steel

Available Finish
Stainless Steel Hairline (S)

Australian Handing
Australian Left Hand (L)
Australian Right Hand (R)

Available Sizes (mm)
Length 1720 to 2420, Centres
985

Fixing Holes Sizes
Door 10mm, Glass 16mm

Specification Code
G1109 - Size - S - L
G1109 - Size - S - R

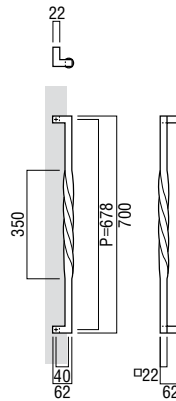

T1109

Base Material
Stainless Steel

Available Finish
Stainless Steel Hairline (S)

Australian Handing
Australian Left Hand (L)
Australian Right Hand (R)

Available Sizes (mm)
Length 700, Centres 678

Fixing Holes Sizes
Door 10mm, Glass 16mm

Specification Code
G1109 - 700 - S - L
G1109 - 700 - S - R

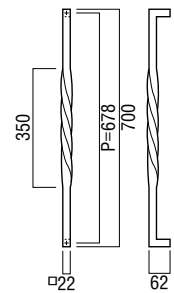

G1109

Base Material
Stainless Steel

Available Finish
Stainless Steel Hairline (S)

Australian Handing
Australian Left Hand (L)
Australian Right Hand (R)

Available Sizes (mm)
Length 700, Centres 678

Fixing Holes Sizes
Door 10mm, Glass 16mm

Specification Code
T1109 - 700 - S - L
T1109 - 700 - S - R



T1205

Base Material
Stainless Steel

Available Finish
Stainless Steel Hairline (S)

Available Sizes (mm)
Length 1720 to 2220, Centres
1660 to 2160

Fixing Holes Sizes
Door 10mm, Glass 16mm

Specification Code
T1205 - Size - S

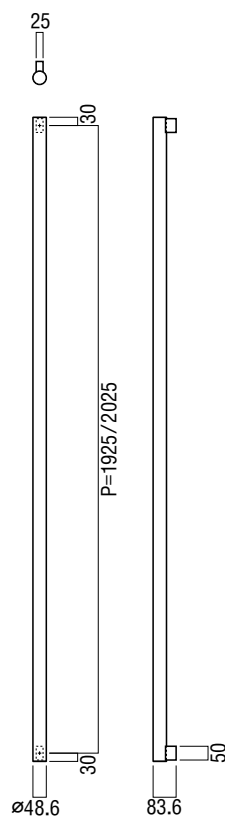





G1103

Base Material
Stainless Steel

Available Finish
Stainless Steel Hairline &
Polished (S)

Available Sizes (mm)
Length 515, Centres 453

Fixing Holes Sizes
Door 10mm, Glass 16mm

Specification Code
G1103 - 515 - S

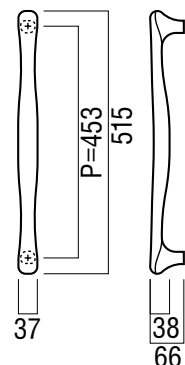





G1104

Base Material
Stainless Steel & Stone

Available Finish
Stainless Steel Satin Black & Stone Silver Shine (S)
Stainless Steel Satin Black & Stone Copper (C)

Available Sizes (mm)
Length 600, Centres 526

Fixing Holes Sizes
Door 10mm, Glass 16mm

Specification Code
G1104 - 600 - finish

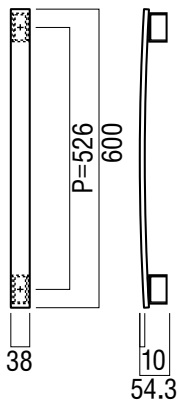





G1203

Base Material
Cast Brass

Available Finish
Cast Brass Oxidized Dark Bronze (B)

Available Sizes (mm)
Length 222.5, Centres 197

Fixing Holes Sizes
Door 8mm, Glass 12mm

Specification Code
G1203 - 222.5 - B

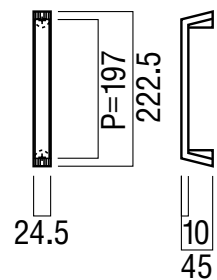



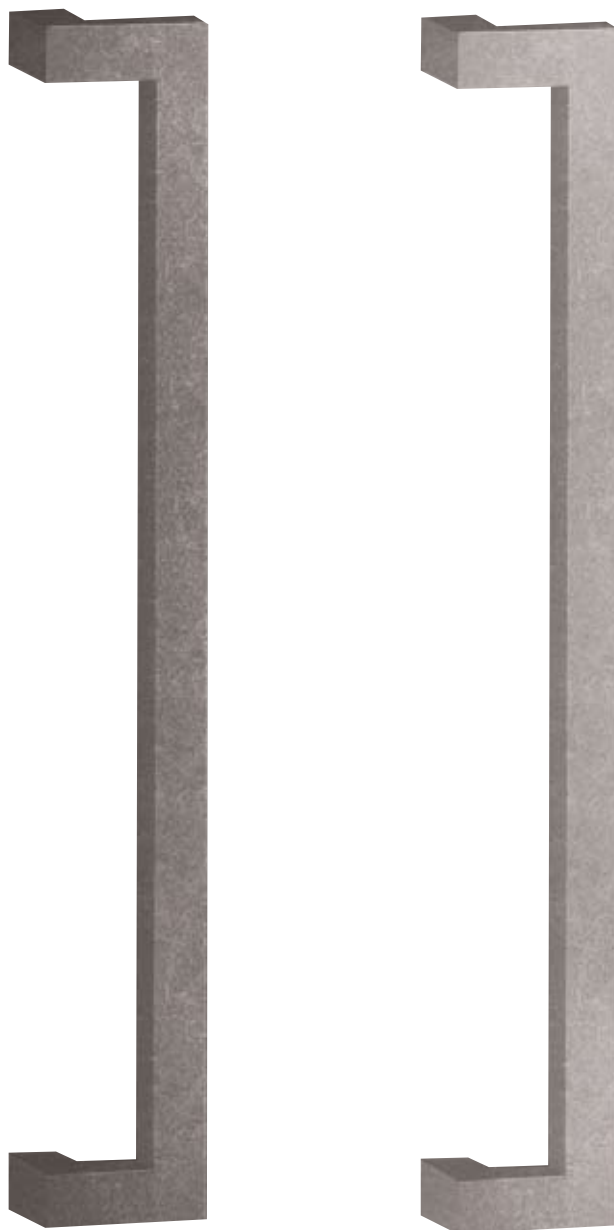

T1550

Base Material
Uni-Well (Cast Aluminium)

Available Finish
Uni-Well (Cast Aluminium)
Anodized Light Colour (L)
Uni-Well (Cast Aluminium)
Anodized Dark Colour (D)

Available Sizes (mm)
Length 500, Centres 475

Fixing Holes Sizes
Door 10mm, Glass 16mm

Specification Code
T1550 - 500 - finish

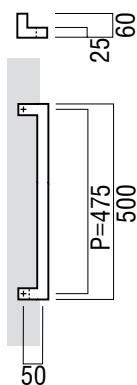



G2750

Base Material
Uni-Well (Cast Aluminium)

Available Finish
Uni-Well (Cast Aluminium)
Anodized Light Colour (L)
Uni-Well (Cast Aluminium)
Anodized Dark Colour (D)

Available Sizes (mm)
Length 452, Centres 425

Fixing Holes Sizes
Door 10mm, Glass 16mm

Specification Code
G2750 - 452 - finish

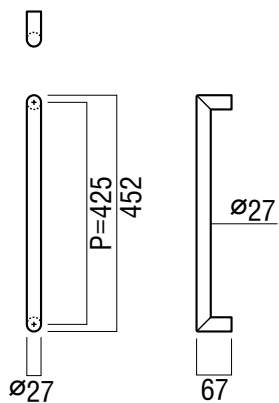

T8050

Base Material
Uni-Well (Cast Aluminium)

Available Finish
Uni-Well (Cast Aluminium)
Anodized Light Colour (L)
Uni-Well (Cast Aluminium)
Anodized Dark Colour (D)

Available Sizes (mm)
Length 600, Centres 565

Fixing Holes Sizes
Door 10mm, Glass 16mm

Specification Code
T8050 - 600 - finish

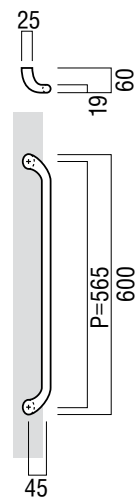

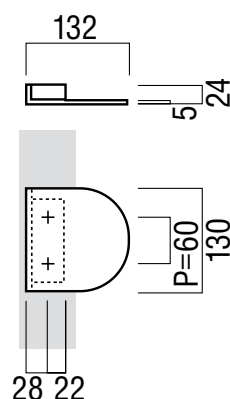
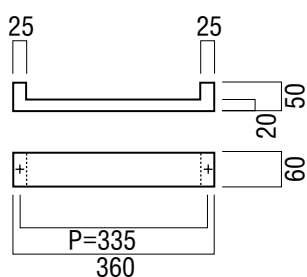

G5080

Base Material
Uni-Well (Cast Aluminium)

Available Finish
Uni-Well (Cast Aluminium)
Anodized Light Colour (L)
Uni-Well (Cast Aluminium)
Anodized Dark Colour (D)

Available Sizes (mm)
Length 360, Centres 335

Fixing Holes Sizes
Door 10mm, Glass 16mm

Specification Code
G5080 - 360 - finish

T215

Base Material
Uni-Well (Cast Aluminium)

Available Finish
Uni-Well (Cast Aluminium)
Anodized Light Colour (L)
Uni-Well (Cast Aluminium)
Anodized Dark Colour (D)

Available Sizes (mm)
Length 130, Centres 60

Fixing Holes Sizes
Door 8mm, Glass 12mm

Specification Code
T215 - 130 - finish

SHINYX

An entrance Handle with two faces;
night and day.

Beautiful light designed in the body by adopting shinyx, a material that is a combination of glass and fluorescent agent, to Door Handles. Day and night, portray two expressions in the entrance—the distinctive texture of glass and a gentle blue light. Combine this with the Lever Handle series for beautiful light coordination.

Shinyx is a pigmented mineral that absorbs energy from natural light and artificial light and releases the energy as light. It requires virtual no maintenance under normal use. Luminescence satisfies the safety mark plate standard (JIS Z 9107) so well, it can be utilized for a variety of purposes, such as guidance products.



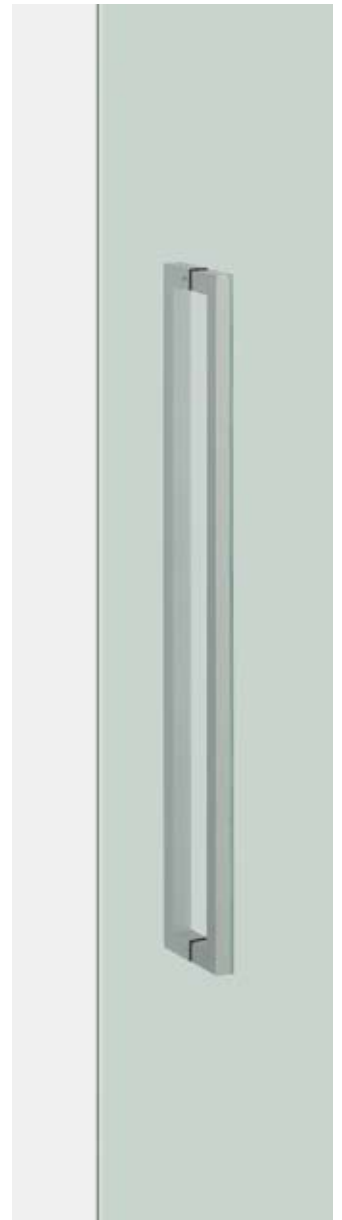
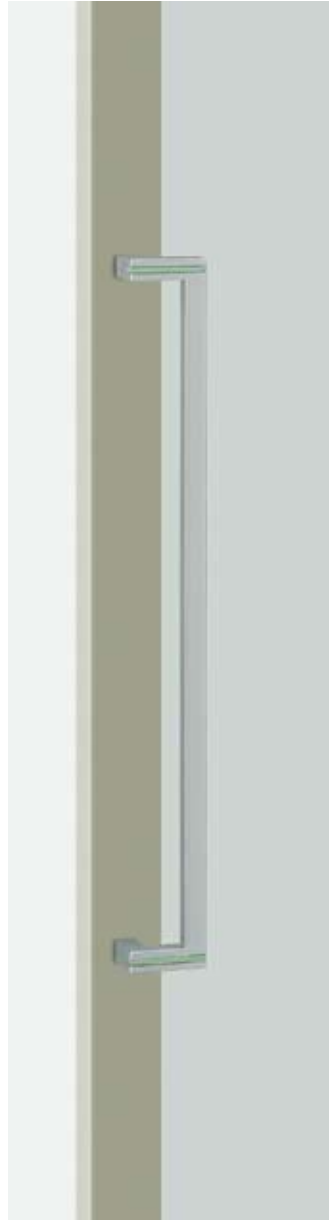
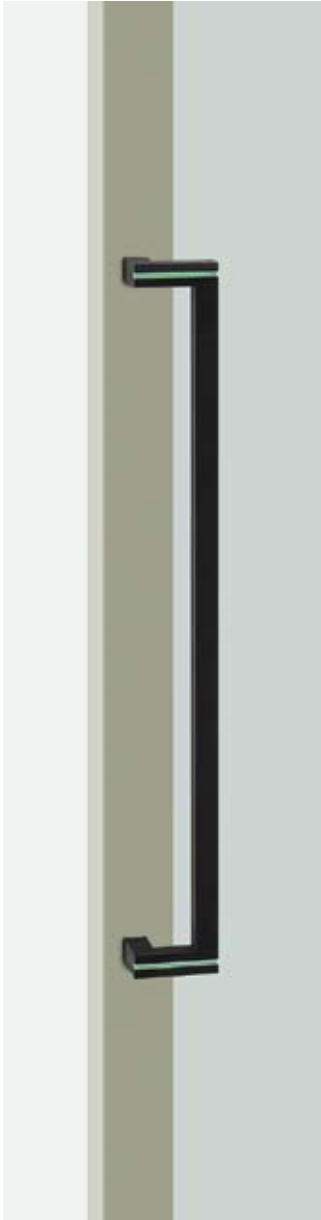

T2745

Base Material
Aluminium

Available Finish
Uni-Frost Anodized Silver & Shinyx (S)
Uni-Frost Anodized Black & Shinyx (B)

Available Sizes (mm)
Length 600, Centres 580

Fixing Holes Sizes
Door 8mm, Glass 12mm

Specification Code
T2745 - 600 - S
T2745 - 600 - B

Requires at least one hour of natural or fluorescent light.

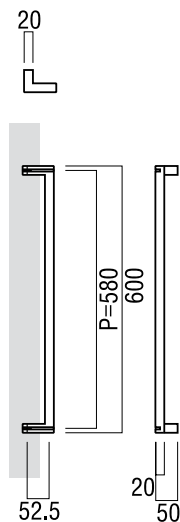

G2746

Base Material
Aluminium

Available Finish
Uni-Frost Anodized Silver & Shinyx (S)
Uni-Frost Anodized Black & Shinyx (B)

Available Sizes (mm)
Length 600, Centres 580

Fixing Holes Sizes
Door 8mm, Glass 12mm

Specification Code
G2746 - 600 - S
G2746 - 600 - B

Requires at least one hour of natural or fluorescent light.

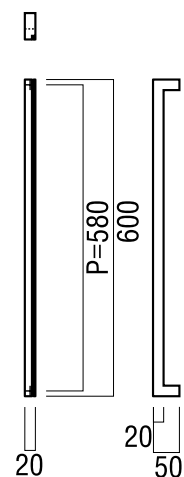

A flowing curvilinear beauty conveying the merits of cast metal.

A door handle, which fascinates those who see it. Utilizing the characteristics of cast aluminium in graceful curved lines that are connected as if flowing. With a form comprising a rather sharp door up stand and a rounded central grip, it has a pleasant tactility when grasped in the hand. The blast finish mitigates the shine, giving a soft impression to the space.





T2980

Base Material
Uni-Cast Aluminium

Available Finish
Blast Anodized Silver (S)
Blast Anodized Black (B)

Available Sizes (mm)
Length 600, Centres 570

Fixing Holes Sizes
Door 10mm, Glass 16mm

Specification Code
T2980 - 600 - S
T2980 - 600 - B

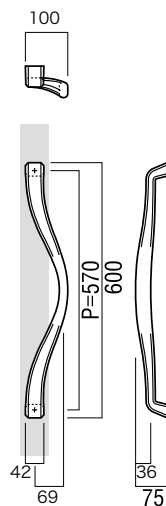



A luxurious shape with the image of cut gemstones.

A design that matches a high class space with the image of faceted crystals. The shadows of the facets vary according to the viewing angle, producing a rich expression. In contrast to the front, the reverse side of the grip is rounded, with a pleasant bulge adjusted to the hand.



G2995

Base Material
Uni-Cast Aluminium

Available Finish
Blast Anodized Umber (U)
Blast Anodized Black (B)

Available Sizes (mm)
Length 600, Centres 570

Fixing Holes Sizes
Door 8mm, Glass 12mm

Specification Code
G2995 - 600 - U
G2995 - 600 - B

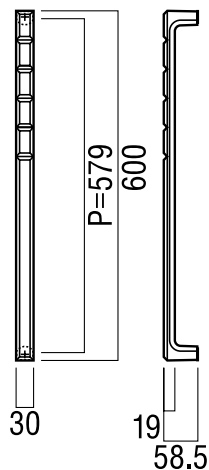



Emphasizing a casual presence within a stylish space.

Simple design harmonizing with a generous space. A door handle that shines in an office, or stylish commercial establishment where people gather. A key point is the beauty of the triangular grip, butt-joined at 45 degrees. A lever handle with the same triangular grip is also available.

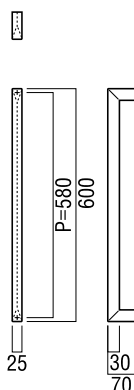
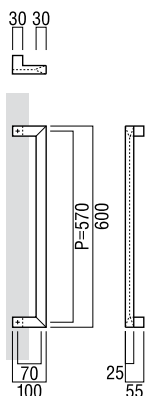
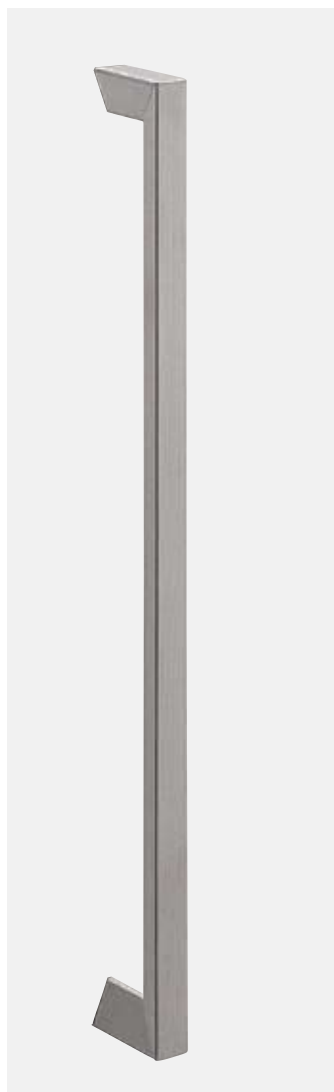
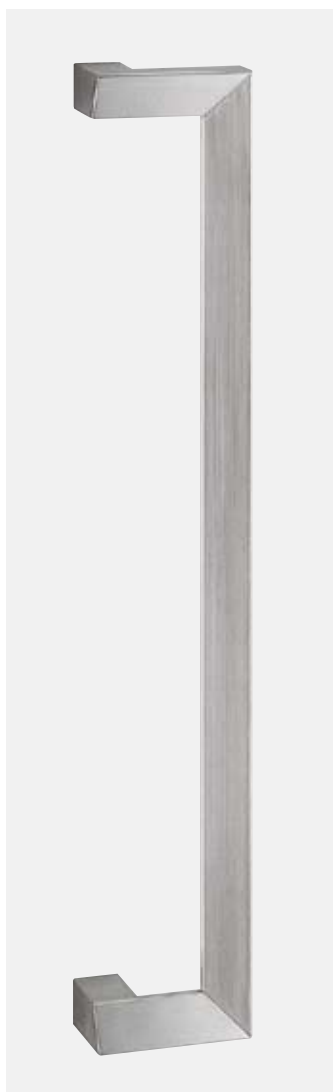

T2920

Base Material
Stainless Steel

Available Finish
Hairline Stainless Steel (H)

Available Sizes (mm)
Length 600, Centres 570

Fixing Holes Sizes
Door 10mm, Glass 16mm

Specification Code
T2920 - 600 - H

G2920

Base Material
Stainless Steel

Available Finish
Hairline Stainless Steel (H)

Available Sizes (mm)
Length 600, Centres 580

Fixing Holes Sizes
Door 8mm, Glass 12mm

Specification Code
G2920 - 600 - H



A teardrop shaped grip; easy to grasp and with a gentle image.

With a curvilinear, yet slender impression; a teardrop-shaped cross-section that emphasises ease of use. While simple, it brims with originality. It may be coordinated with lever handles of the same concept.

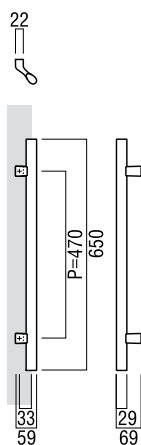
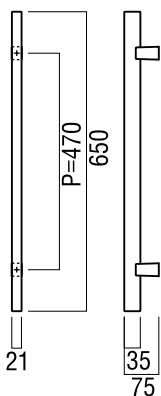

G2925

Base Material
Stainless Steel

Available Finish
Hairline Stainless Steel (H)

Available Sizes (mm)
Length 650, Centres 470

Fixing Holes Sizes
Door 8mm, Glass 12mm

Specification Code
G2925 - 650 - H

T2925

Base Material
Stainless Steel

Available Finish
Hairline Stainless Steel (H)

Available Sizes (mm)
Length 650, Centres 470

Fixing Holes Sizes
Door 8mm, Glass 12mm

Specification Code
T2925 - 650 - H



An implementation of the often required “two-point-support,” with an exceptional length of 3000mm.

Using thin Stainless Steel pipes, a square type with a crisp impression and a round type with a gentle impression are available. A two-point fixing design without an intermediate support, it neatly fits to the door. The thickness of the round type is 3mm, giving a firm resistance. The bulge is for ease of grasp, as well as increasing strength.

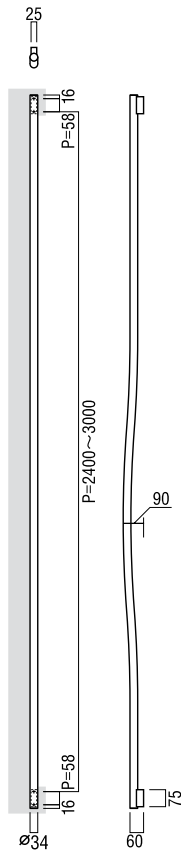

T2970

Base Material
Stainless Steel

Available Finish
Hairline Stainless Steel (H)
Polished Stainless (P)

Available Sizes (mm)
Length 2400 - 3000mm

Fixing Holes Sizes
Door 10mm, Glass 16mm

Specification Code
T2970 - Size - H
T2970 - Size - P

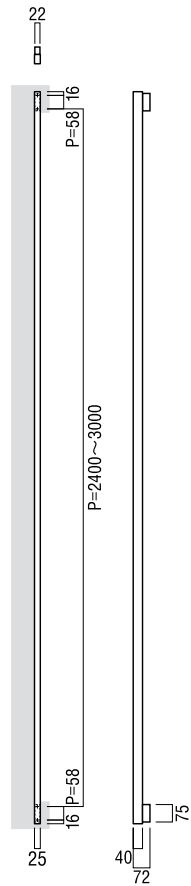
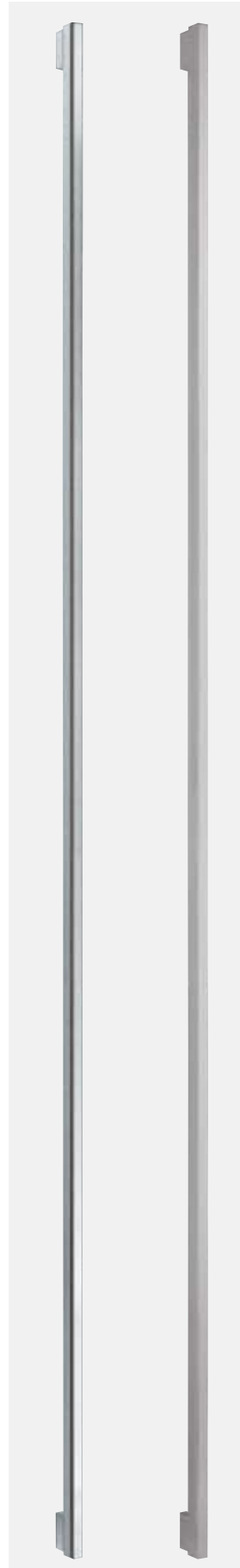

T2971

Base Material
Stainless Steel

Available Finish
Hairline Stainless Steel (H)
Polished Stainless (P)

Available Sizes (mm)
Length 2400 - 3000mm

Fixing Holes Sizes
Door 10mm, Glass 16mm

Specification Code
T2971 - Size - H
T2971 - Size - P

A dark-colored door is shown, partially open, revealing a bright light strip running vertically through its center. The door has a sleek, modern design with a dark finish. The background is a plain, light-colored wall.

Ensuring refreshing air-flow without showing ventilation slots.

A door handle that eliminates the need for a grille. Installed on a door that requires ventilation. By adopting an aluminium finish which has a particular tactility, it gives a sense of easy use. The design is neatly unified with the door, and is simple to install, with no visible screws. It may also be used as an ordinary door handle.

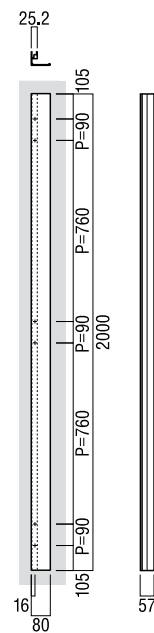
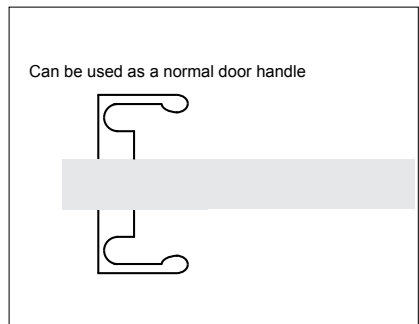
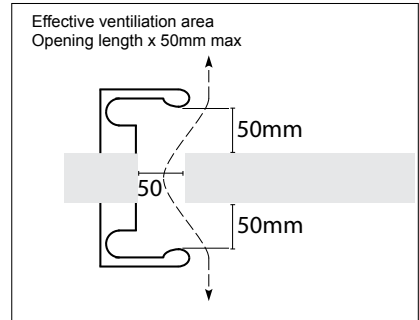
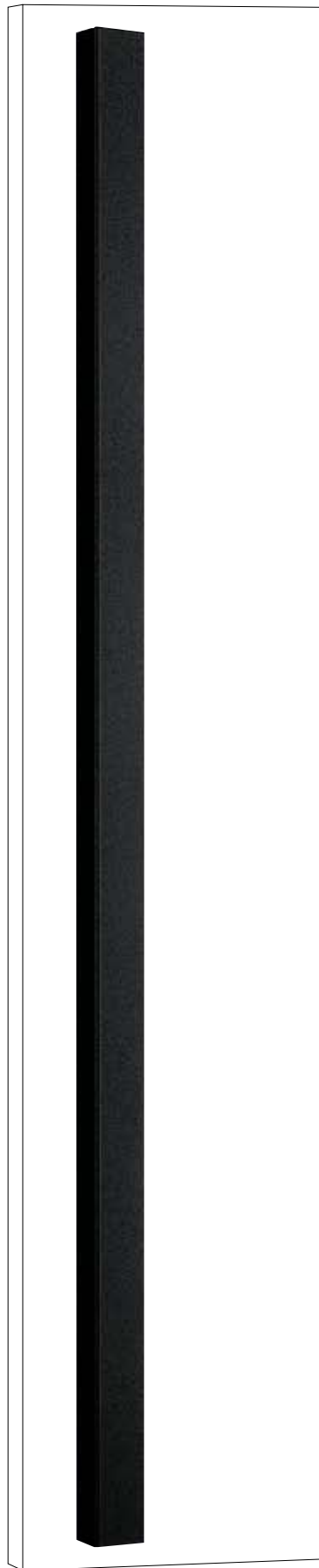
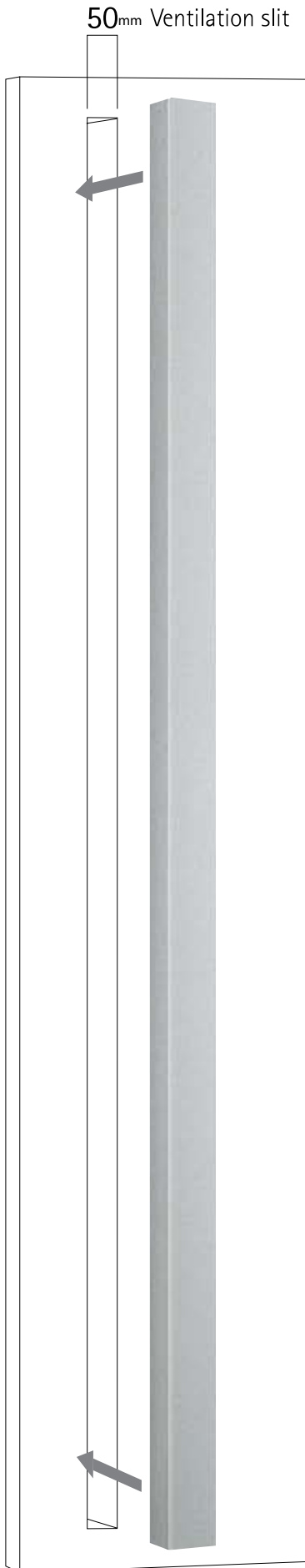

T2955

Base Material
Aluminium

Available Finish
Aluminium Anodized Sand Silver (S)
Aluminium Anodized Sand Black (B)

Available Sizes (mm)
Length 2000

Fixing Holes Sizes
Door 8mm

Specification Code
T2955 - 2000 - S
T2955 - 2000 - M

Toward various door accents with a minimal presence

Harmonizing with wooden doors as well as glass doors without overemphasizing size. The shine of the 4mm-thick plate on the inner face is an accent when looked at diagonally from the right angle. It may be installed vertically or horizontally and several may be stylishly aligned.

The freedom of expression in coordinating them with multiple doors.



SMALL ENTRY PULLS *by Elmes of Japan*

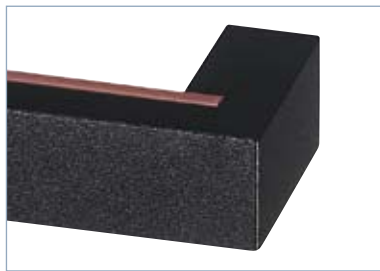
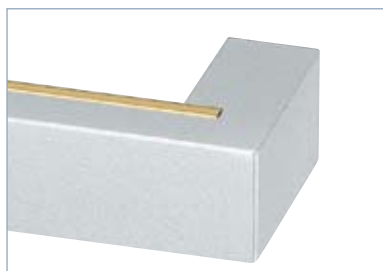

Cosmetic plates are available via easy order, please enquire for details

G2950

Base Material
Aluminium

Available Finish
 Uni-Frost Anodized Silver with Anodized Silver insert (SS)
 Uni-Frost Anodized Silver with Anodized Pale Gold insert (PG)
 Uni-Frost Anodized Black with Anodized Black insert (BB)
 Blast Anodized Black with Brass, Oxidized Dark Bronze insert (BO)

Available Sizes (mm)
Length 159, Centres 145

Fixing Holes Sizes
Door 7mm, Glass 12mm

Specification Code
G2950 - 159 - Finish

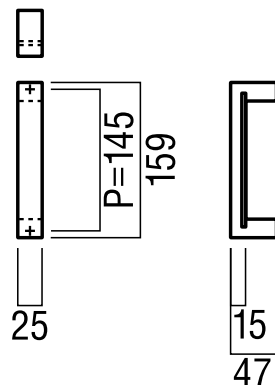



Beautiful right down to the smallest detail; a sliding door that disappears completely into the wall.

A type of sliding door installed so as to allow the end of the door to be concealed. Even when the sliding door has been opened completely, it may be grasped and pulled out. Because it is unnecessary to leave the handle part of the sliding door exposed, the neat impression of a completely flat door opening is obtained, ensuring an even wider opening. The fixing screws are behind an accessory plate providing a seamless finish. This is suitable for making high-grade details in spaces such as luxury hotels.



T2940

Base Material
Brass

Available Finish
Bright Chrome (C)
Oxidized Dark Bronze (B)

Available Sizes (mm)
Length 400

Fixing
Rebated into timber doors only

Specification Code
T2940 - 400 - finish

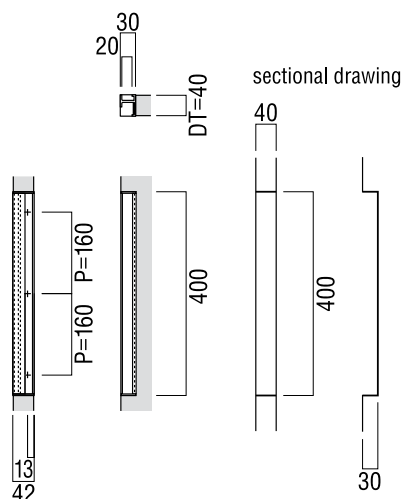

CLASSICA



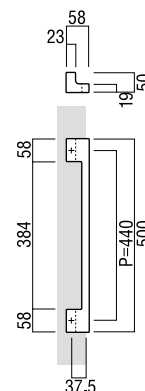
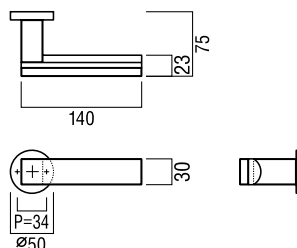
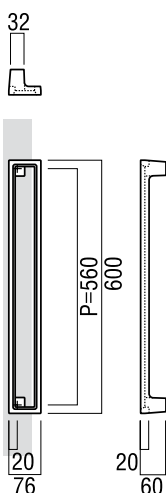
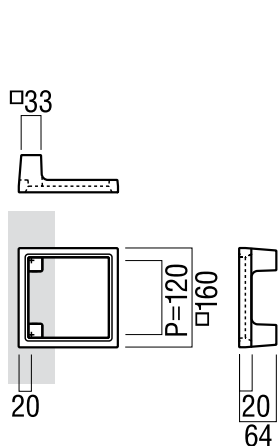
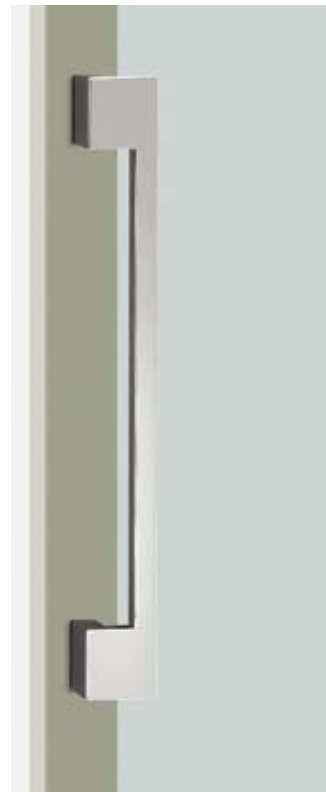
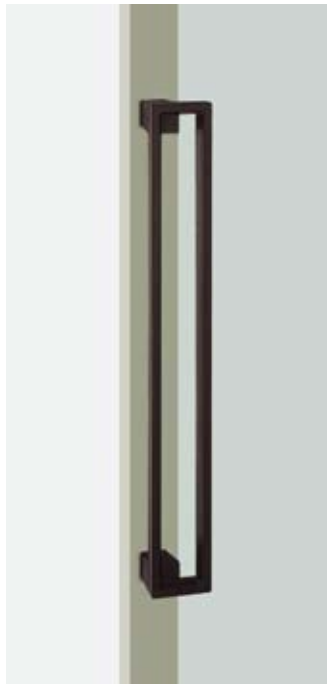

T2619

Base Material
Japanese Cast Iron (Nambu-Tetsu)

Available Finish
Baked Finish Red Rust Colour (R)
Baked Finish Iron Rust Colour (I)

Available Sizes (mm)
See dimension image above

Fixing Holes Sizes
Door 10mm, Glass 16mm

Specification Code
T2619- 160- R
T2619- 160- I

T2719

Base Material
Japanese Cast Iron (Nambu-Tetsu)

Available Finish
Baked Finish Red Rust Colour (R)
Baked Finish Iron Rust Colour (I)

Available Sizes (mm)
Length 600, Centres 560

Fixing Holes Sizes
Door 10mm, Glass 16mm

Specification Code
T2719- 600- R
T2719- 600- I

UL729

Base Material
Japanese Cast Iron (Nambu-Tetsu)

Available Finish
Baked Finish Red Rust Colour (R)
Baked Finish Iron Rust Colour (I)

Type
Lock Sets (L)
Passage Sets (P)
Privacy sets (PS)

Suitability
Internal & External Doors

Specification Code
UL551 - CP - Type
UL551 - PB - Type
UL551 - R - Type

T1570

Base Material
Uni-Cast Aluminium

Available Finish
Anodized Silver (S)

Available Sizes (mm)
Length 500, Centres 440

Fixing Holes Sizes
Door 8mm, Glass 12mm

Specification Code
T1570 - 500 - S

SMALL ENTRY PULLS *by Elmes of Japan*



Inside

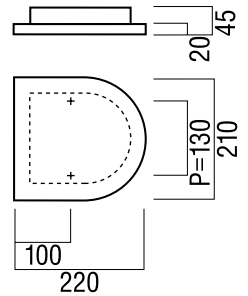
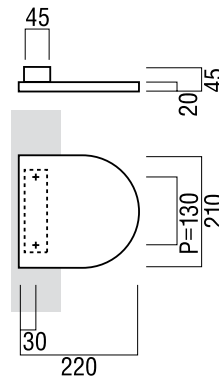
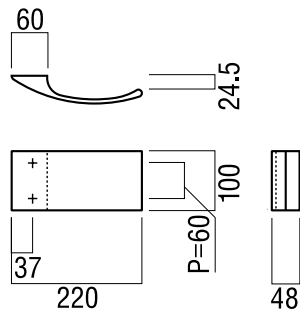
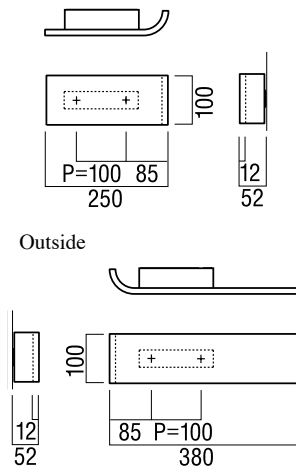

G2616

Base Material
Uni-Cast Aluminium

Available Finish
Blast Anodized Silver (S)
Blast Anodized Black (B)

Available Sizes (mm)
See dimension image above

Fixing Holes Sizes
Door 10mm, Glass 16mm

Specification Code
G2616 - 380 - finish

T2615

Base Material
Uni-Cast Aluminium

Available Finish
Blast Anodized Silver (S)
Blast Anodized Black (B)

Available Sizes (mm)
See dimension image above

Fixing Holes Sizes
Door 10mm, Glass 16mm

Specification Code
T2615 - 220 - finish

T2100

Base Material
Uni-Cast Aluminium

Available Finish
Blast Anodized Black (B)

Available Sizes (mm)
See dimension image above

Fixing Holes Sizes
Door 10mm, Glass 16mm

Specification Code
T2100 - 220 - B

G2100

Base Material
Uni-Cast Aluminium

Available Finish
Blast Anodized Black (B)

Available Sizes (mm)
See dimension image above

Fixing Holes Sizes
Door 10mm, Glass 16mm

Specification Code
G2100 - 220 - B

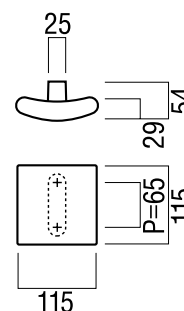
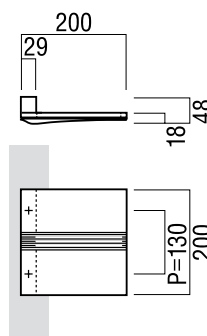
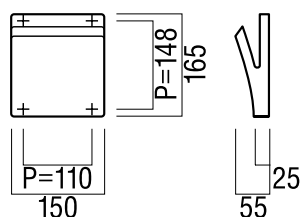

G2404

Base Material
Aluminium

Available Finish
Blast Anodized Silver (underside) & Silver (outside) (S)
Blast Anodized Black (underside) & Black (outside) (B)

Available Sizes (mm)
See dimension image above

Fixing Holes Sizes
Door 8mm, Glass 12mm

Specification Code
G2404 - 165 - finish

T3341

Base Material
Uni-Cast Aluminium & Stainless Steel

Available Finish
Blast Anodized Silver and Polished Stainless Steel (S)

Available Sizes (mm)
See dimension image above

Fixing Holes Sizes
Door 10mm, Glass 16mm

Specification Code
T3341 - 200 - S

G345

Base Material
Stainless Steel or Brass

Available Finish
Polished Stainless Steel (PS)
Polished Brass (BR)

Available Sizes (mm)
See dimension image above

Fixing Holes Sizes
Door 10mm, Glass 16mm

Specification Code
G345 - 115 - finish

SMALL ENTRY PULLS *by Elmes of Japan*

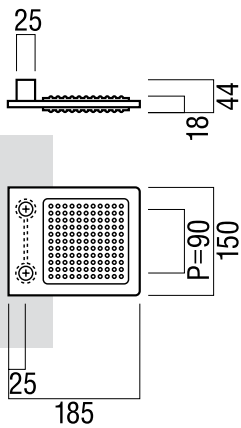

T3048

Base Material
Resin (colour) & Aluminium

Available Finish
Anodized Silver & Green Grey (01)
Anodized Silver & Blue Grey (02)
Anodized Silver & Brown Red (03)
Anodized Black & Green Grey (04)
Anodized Black & Blue Grey (05)
Anodized Black & Brown Red (06)

Available Sizes (mm)
See dimension image above

Fixing Holes Sizes
Door 10mm, Glass 16mm

Specification Code
T3048 - 185 - finish

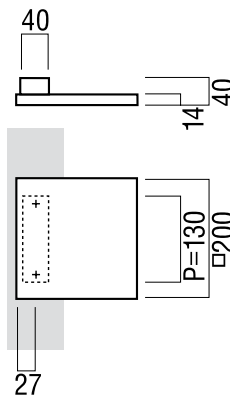

T2300

Base Material
Uni-Cast Aluminium

Available Finish
Anodized Umber (U)

Available Sizes (mm)
See dimension image above

Fixing Holes Sizes
Door 10mm, Glass 16mm

Specification Code
T2300 - 200 - U

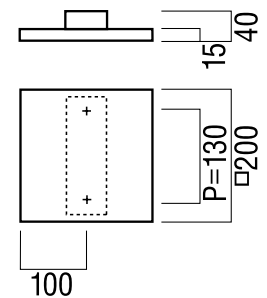

G2300

Base Material
Uni-Cast Aluminium

Available Finish
Anodized Umber (U)

Available Sizes (mm)
See dimension image above

Fixing Holes Sizes
Door 10mm, Glass 16mm

Specification Code
G2300 - 200 - U

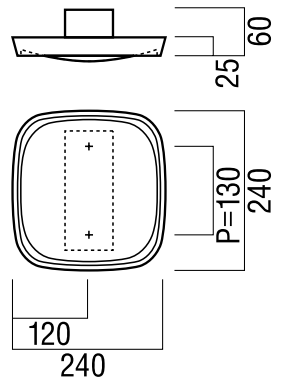
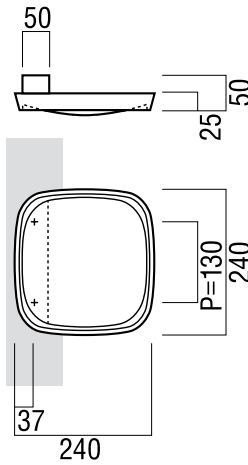
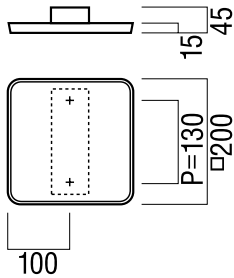
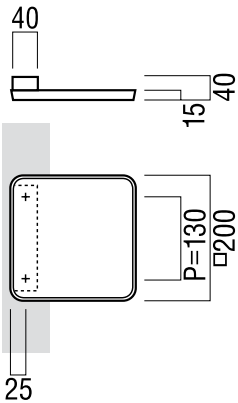

T6400

Base Material
Japanese Cast Iron (Nambu-Tetsu)

Available Finish
Baked Finish Charcoal (C)

Available Sizes (mm)
See dimension image above

Fixing Holes Sizes
Door 10mm, Glass 16mm

Specification Code
T6400 - 200 - C

G6400

Base Material
Japanese Cast Iron (Nambu-Tetsu)

Available Finish
Baked Finish Charcoal (C)

Available Sizes (mm)
See dimension image above

Fixing Holes Sizes
Door 10mm, Glass 16mm

Specification Code
G6400 - 200 - C

T7067

Base Material
Japanese Cast Iron (Nambu-Tetsu)

Available Finish
Baked Finish Brown (B)

Available Sizes (mm)
See dimension image above

Fixing Holes Sizes
Door 10mm, Glass 16mm

Specification Code
T7067 - 240 - B

G7067

Base Material
Japanese Cast Iron (Nambu-Tetsu)

Available Finish
Baked Finish Brown (B)

Available Sizes (mm)
See dimension image above

Fixing Holes Sizes
Door 10mm, Glass 16mm

Specification Code
G7067 - 240 - B

SMALL ENTRY PULLS *by Elmes of Japan*

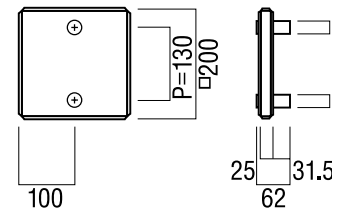
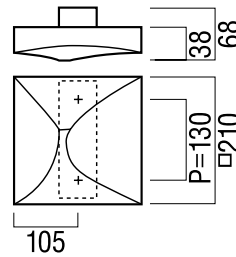
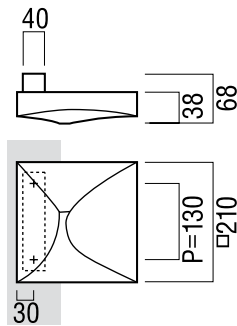
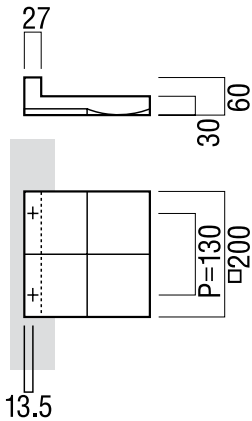

T2002

Base Material
Uni-Cast Aluminium

Available Finish
Blast Anodized Stainless Steel Colour (S)
Blast Anodized Black (B)

Available Sizes (mm)
See dimension image above

Fixing Holes Sizes
Door 10mm, Glass 16mm

Specification Code
T2002 - 200 - finish

T8800

Base Material
Craft Porcelain & Uni-Cast Aluminium

Available Finish
Glazing, Matt White & Blast Anodized Silver Colour (W)

Available Sizes (mm)
See dimension image above

Fixing Holes Sizes
Door 10mm, Glass 16mm

Specification Code
T8800 - 210 - W

G8800

Base Material
Craft Porcelain & Uni-Cast Aluminium

Available Finish
Glazing, Matt White & Blast Anodized Silver Colour (W)

Available Sizes (mm)
See dimension image above

Fixing Holes Sizes
Door 10mm, Glass 16mm

Specification Code
T8800 - 210 - W

G6000

Base Material
Glass & Stainless Steel

Available Finish
Transparent Glass & Stainless Steel Hairline (G)

Available Sizes (mm)
See dimension image above

Fixing Holes Sizes
Door 10mm, Glass 16mm

Specification Code
G6000 - 200 - G

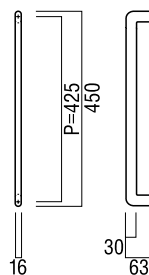
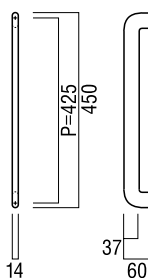
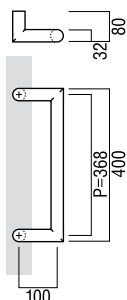
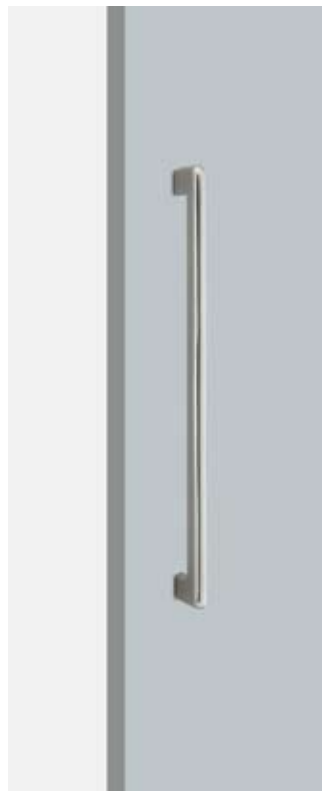
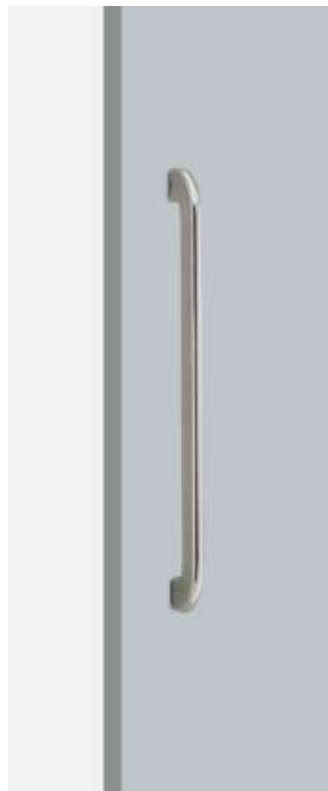

T5570

Base Material
Stainless Steel

Available Finish
Polished Stainless Steel (P)

Available Sizes (mm)
Length 400, Centres 368

Fixing Holes Sizes
Door 10mm, Glass 16mm

Specification Code
T5570 - 400 - P

T5210R

Base Material
Stainless Steel

Available Finish
Polished Stainless Steel (P)

Available Sizes (mm)
Length 450, Centres 425

Fixing Holes Sizes
Door 8mm

Specification Code
T5210R - 450 - P
Note: Not Suitable for Glass
Doors

T5210S

Base Material
Uni-Cast Aluminium

Available Finish
Anodized Silver Colour (S)

Available Sizes (mm)
Length 450, Centres 425

Fixing Holes Sizes
Door 8mm

Specification Code
T5210S - 450 - P
Note: Not Suitable for Glass
Doors

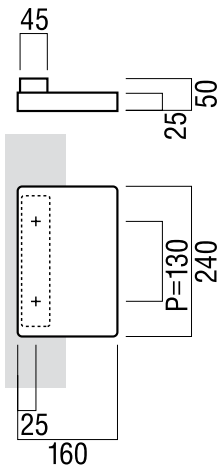

T3702

Base Material
Unimin (Melamine Resin)

Available Finish
White (W)
Black (B)

Available Sizes (mm)
See dimension image above

Fixing Holes Sizes
Door 10mm, Glass 16mm

Specification Code
T3702 - 240 - W
T3702 - 240 - B

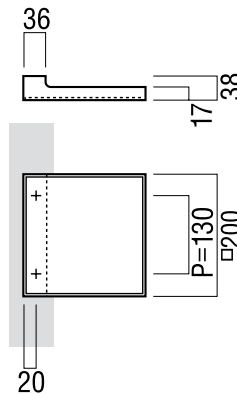

T7800

Base Material
Laminated Veneer & Uni-Cast Aluminium

Available Finish
Black & Blast Anodized Silver Colour (B)

Available Sizes (mm)
See dimension image above

Fixing Holes Sizes
Door 10mm, Glass 16mm

Specification Code
T7800 - 200 - B

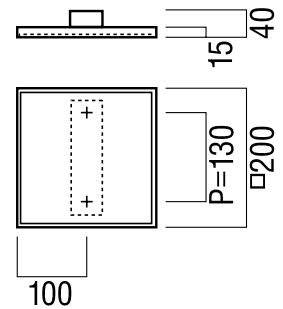

G7800

Base Material
Laminated Veneer & Uni-Cast Aluminium

Available Finish
Black & Blast Anodized Silver Colour (B)

Available Sizes (mm)
See dimension image above

Fixing Holes Sizes
Door 10mm, Glass 16mm

Specification Code
G7800 - 200 - B

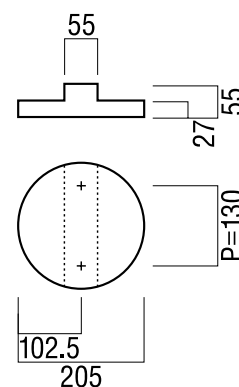
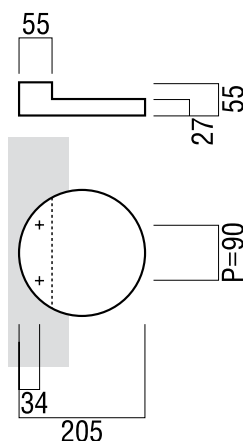
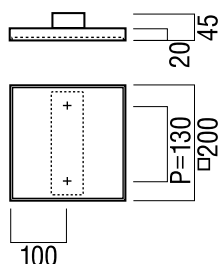
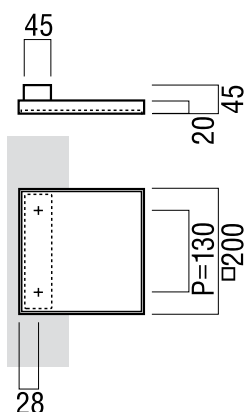

T5701

Base Material
Laminated Veneer & Stainless Steel

Available Finish
Black & Stainless Steel Hairline (B)

Available Sizes (mm)
See dimension image above

Fixing Holes Sizes
Door 10mm, Glass 16mm

Specification Code
T5701 - 200 - B

G5701

Base Material
Laminated Veneer & Stainless Steel

Available Finish
Black & Stainless Steel Hairline (B)

Available Sizes (mm)
See dimension image above

Fixing Holes Sizes
Door 10mm, Glass 16mm

Specification Code
G5701 - 200 - B

T4260

Base Material
Uni-Cast Aluminium

Available Finish
Blast Anodized Silver Colour (S)

Available Sizes (mm)
See dimension image above

Fixing Holes Sizes
Door 10mm, Glass 16mm

Specification Code
T4260 - 205 - S

G4260

Base Material
Uni-Cast Aluminium

Available Finish
Blast Anodized Silver Colour (S)

Available Sizes (mm)
See dimension image above

Fixing Holes Sizes
Door 10mm, Glass 16mm

Specification Code
G4260 - 205 - S



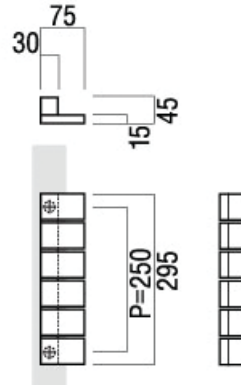
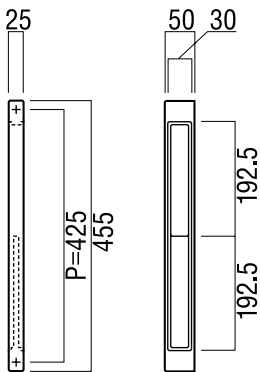
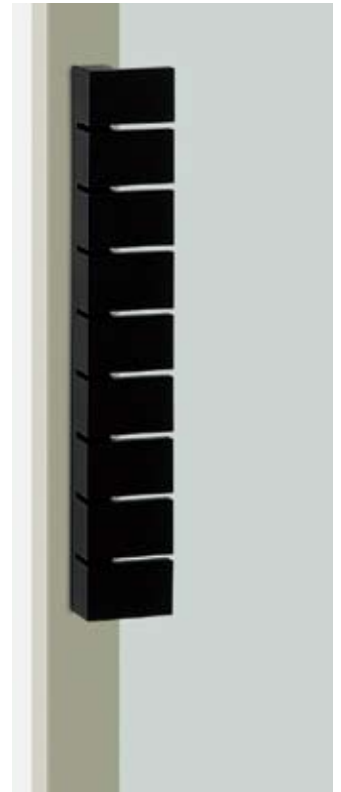

G2401

Base Material
Aluminium

Available Finish
Blast Anodized Silver & Anodized Silver (S)
Blast Anodized Black & Anodized Black (B)

Available Sizes (mm)
Length 455, Centres 425

Fixing Holes Sizes
Door 10mm, Glass 16mm

Specification Code
G2401 - 455 - finish

T2309

Base Material
Aluminium

Available Finish
Uni-Frost Anodized Silver (S)
Uni-Frost Anodized Black (B)

Available Sizes (mm)
Length 445, Centres 400
Length 295, Centres 250

Fixing Holes Sizes
Door 10mm, Glass 16mm

Specification Code
T2309 - size - finish



An expression of plywood matching simple modern space

Plywood is slim sheets 1mm thick stacked perpendicular to each other and formed by pressure and heat. Door handles that feature a curved form, a characteristic that is difficult with natural wood due to its superior strength. In using the same material as furniture it harmonizes with the simple modern and mid-century taste preferred in recent years. Even the laminating pattern on the side of the handle has a modern essence.



T6516

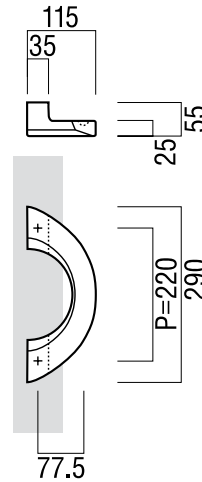

Base Material
Uni-Cast Aluminium

Available Finish
Silver Colour & Blast Anodized
Silver Colour (S)
Blast Anodized Black (B)

Available Sizes (mm)
See dimension image left

Fixing Holes Sizes
Door 10mm, Glass 16mm

Specification Code
T6516 - 290 - S
T6516 - 290 - B

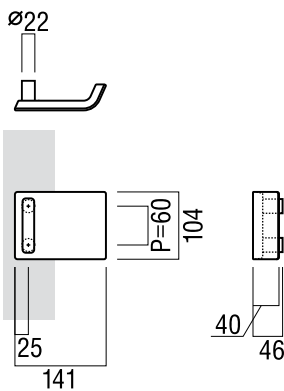

T2810

Base Material
Plywood & Stainless Steel

Available Finish
Plywood White & Stainless Steel
Hairline (W)

Plywood Natural Colour &
Stainless Steel Hairline (N)

Plywood Walnut & Stainless Steel
Hairline (WN)

Available Sizes (mm)
See dimension image above

Fixing Holes Sizes
Door 8mm, Glass 12mm

Specification Code
T2810 - 141 - finish



SMALL ENTRY PULLS *by Elmes of Japan*

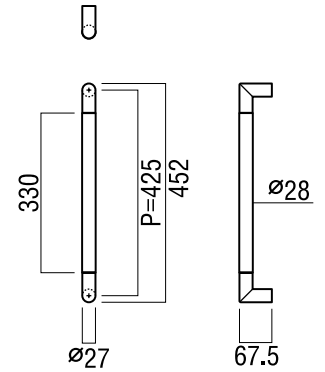
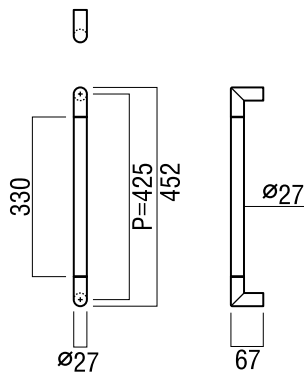
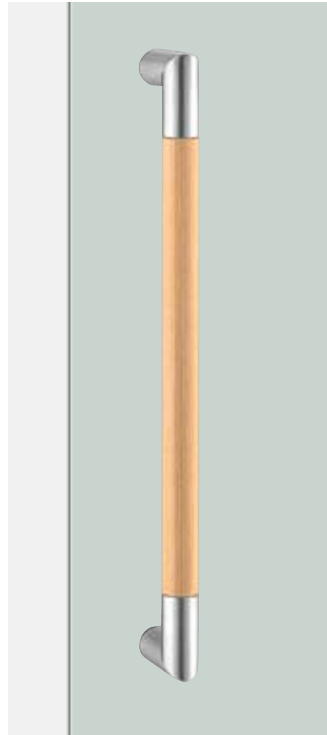
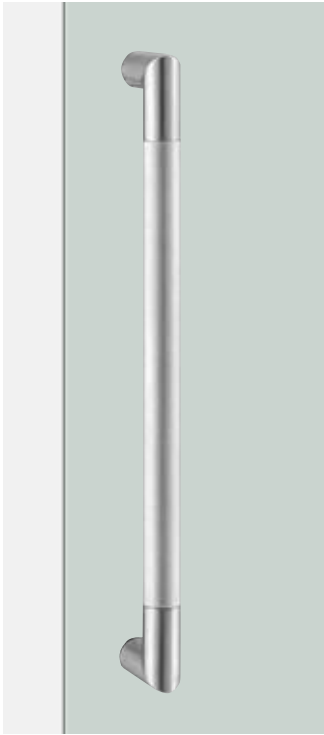

G2750

Base Material
Stainless Steel & Uniwood
(Antibacterial Compressed Wood)

Available Finish
Stainless Steel & Hairline (S)

Uni-Wood Light White & Stainless
Steel Hairline (W)

Uni-Wood Light Scotch Colour &
Stainless Steel Hairline (SC)

Available Sizes (mm)
Length 452, Centres 425
Length 600, Centres 573

Fixing Holes Sizes
Door 10mm, Glass 16mm

Specification Code
G2750 - 425 - finish
G2750 - 600 - finish

G2750

Base Material
Aluminium & Stainless Steel

Available Finish
Aluminium Blast Anodized Black
& Stainless Steel Hairline (AB)

Available Sizes (mm)
Length 452, Centres 425
Length 600, Centres 573

Fixing Holes Sizes
Door 10mm, Glass 16mm

Specification Code
G2750 - 452 - AB
G2750 - 600 - AB

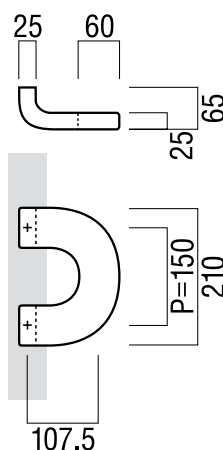
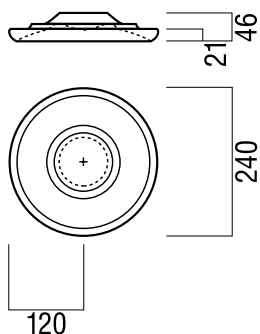
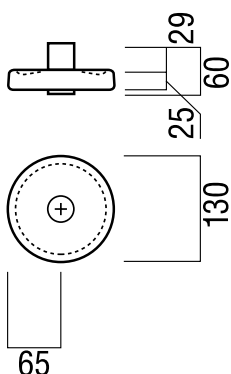
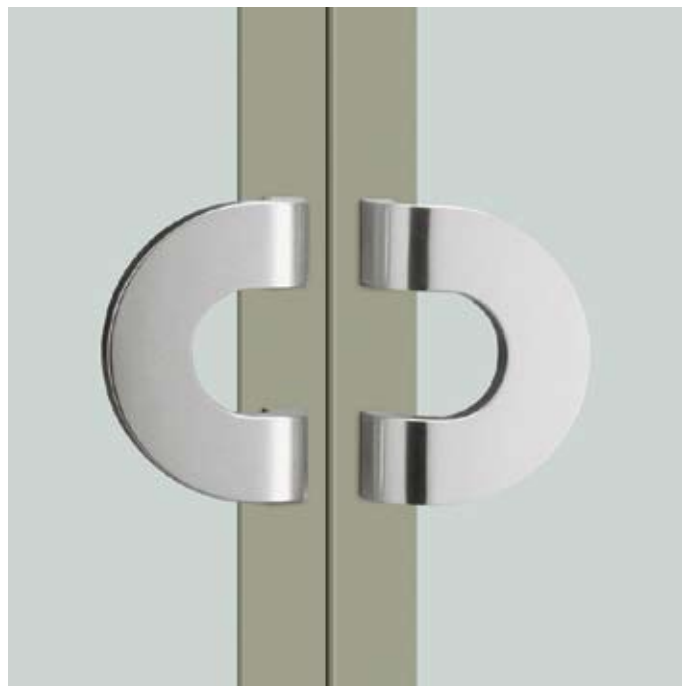

G12300

Base Material
Glass & Stainless Steel

Available Finish
Transparent Glass & Stainless Steel Hairline (G)

Available Sizes (mm)
See dimension image above

Fixing Holes Sizes
Door 10mm, Glass 16mm

Specification Code
G12300 - 130 - G

G12500

Base Material
Glass & Stainless Steel

Available Finish
Transparent Glass & Stainless Steel Hairline (G)

Available Sizes (mm)
See dimension image above

Fixing Holes Sizes
Glass 16mm

Specification Code
G12500 - 240 - G
Note: Not Suitable for Flush Doors

T1520

Base Material
Uni-Cast Aluminium

Available Finish
Anodized Silver Colour (S)

Available Sizes (mm)
See dimension image above

Fixing Holes Sizes
Door 10mm, Glass 16mm

Specification Code
T1520 - 210 - S

The beauty of industrial arts through forging and the volume of casting

A door handle accented by a three-dimensional impression peculiar to forging within the expression typical of aluminium casting. A beauty that is particular down to the last detail is attractive to those who touch it and provokes expectations of the room





T2880

Base Material
Uni-Cast Aluminium

Available Finish
Blast Anodized Silver Colour (S)
Blast Anodized Black (B)

Available Sizes (mm)
Length 600, Centres 573

Fixing Holes Sizes
Door 10mm, Glass 16mm

Specification Code
T2880 - 600 - S
T2880 - 600 - B

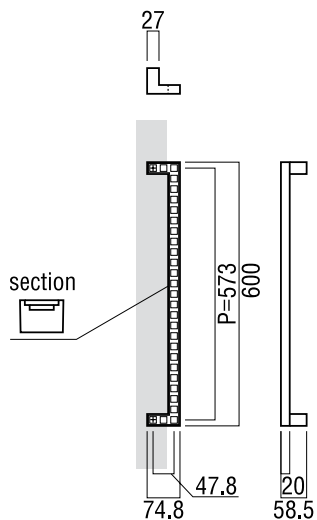

MEDIUM ENTRY PULLS *by Elmes of Japan*

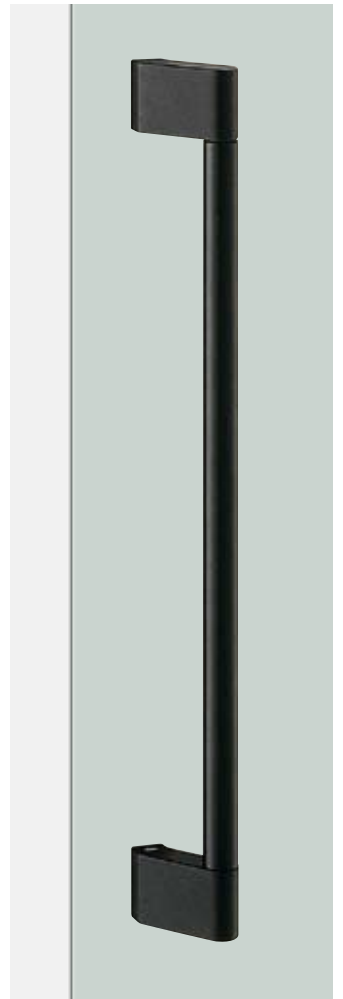
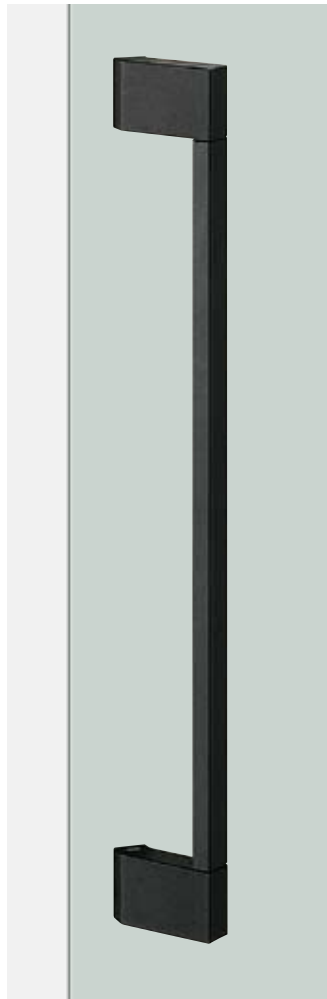
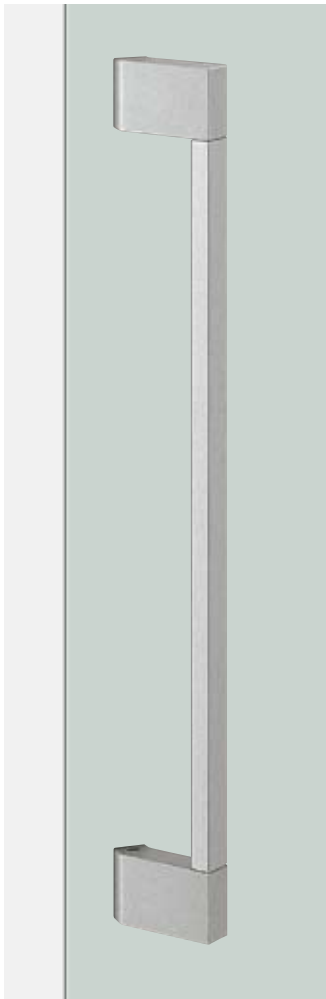

T2860

Base Material
Aluminium

Available Finish
Uni Frost Anodized Silver Colour (S)
Uni Frost Anodized Black (B)

Available Sizes (mm)
Length 600, Centres 550

Fixing Holes Sizes
Door 8mm, Glass 12mm

Specification Code
T2860 - 600 - S
T2860 - 600 - B

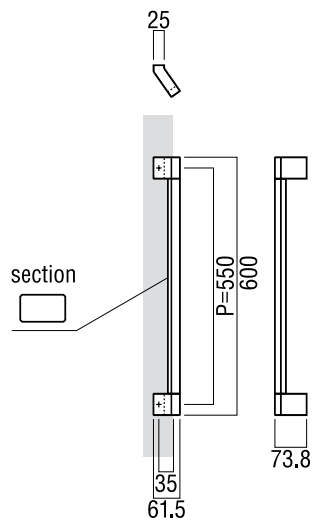

T2864

Base Material
Aluminium

Available Finish
Uni Frost Anodized Silver Colour (S)
Uni Frost Anodized Black (B)

Available Sizes (mm)
Length 600, Centres 550

Fixing Holes Sizes
Door 8mm, Glass 12mm

Specification Code
T2864 - 600 - S
T2864 - 600 - B

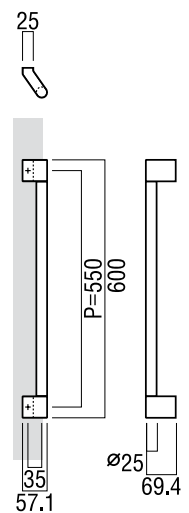



T685

Base Material
Stainless Steel

Available Finish
Hairline Stainless Steel (H)
Polished Stainless Polished (P)

Available Sizes (mm)
Length 443, Centres 425
Length 748, Centres 730

Fixing Holes Sizes
Door 10mm, Glass 12mm

Specification Code
T685 - 443 - finish
T685 - 748 - finish

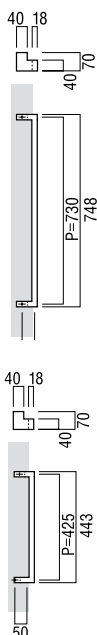

T685

Base Material
Brass

Available Finish
Polished Brass (PB)

Available Sizes (mm)
Length 445, Centres 425
Length 750, Centres 730

Fixing Holes Sizes
Door 10mm, Glass 12mm

Specification Code
T685 - 445 - PB
T685 - 750 - PB

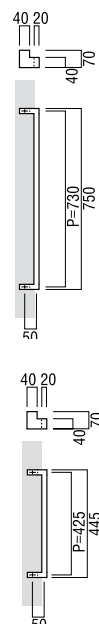

MEDIUM ENTRY PULLS *by Elmes of Japan*

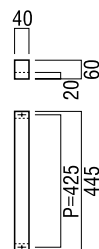
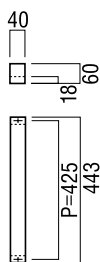

G685

Base Material
Stainless Steel

Available Finish
Hairline Stainless Steel (H)
Polished Stainless Polished (P)

Available Sizes (mm)
Length 443, Centres 425
Length 748, Centres 730

Fixing Holes Sizes
Door 10mm, Glass 12mm

Specification Code
G685 - 443 - finish
G685 - 748 - finish

G685

Base Material
Brass

Available Finish
Polished Brass (PB)

Available Sizes (mm)
Length 445, Centres 425
Length 750, Centres 730

Fixing Holes Sizes
Door 10mm, Glass 12mm

Specification Code
G685 - 445 - PB
G685 - 750 - PB

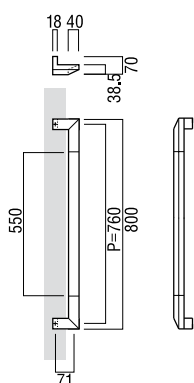
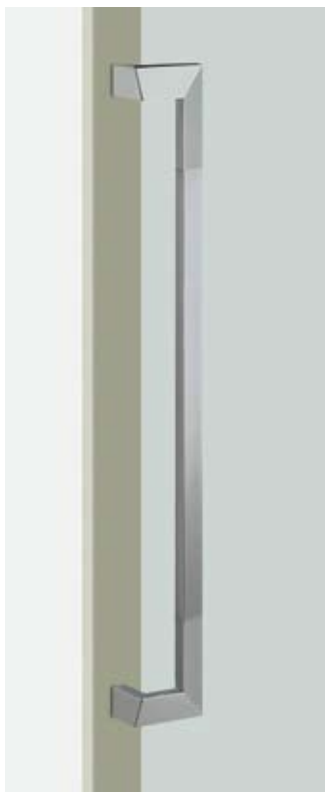

T3077

Base Material
Stainless Steel

Available Finish
Hairline & Polished Stainless Steel (H)

Available Sizes (mm)
Length 800, Centres 760

See Page 141 for longer version
T3087: Length 1400, Centres 1361

Fixing Holes Sizes
Door 10mm, Glass 16mm
Door 10mm, Glass 12mm (T3087)

Specification Code
T3077 - 800 - H
T3087 - 1400 - H

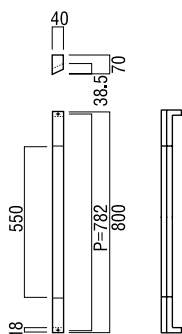
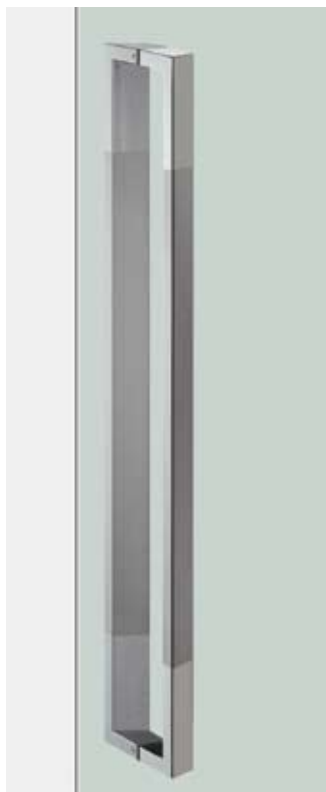

G3078

Base Material
Stainless Steel

Available Finish
Hairline & Polished Stainless Steel (H)

Available Sizes (mm)
Length 800, Centres 782
Length 600, Centres 582

Fixing Holes Sizes
Door 10mm, Glass 16mm

Specification Code
G3078 - 800 - H
G3078 - 600 - H

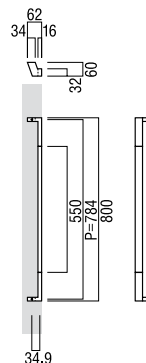
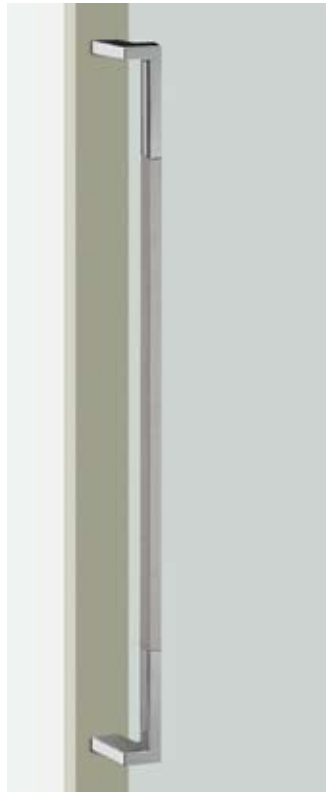

T8630

Base Material
Stainless Steel

Available Finish
Hairline & Polished Stainless Steel (H)

Available Sizes (mm)
Length 800, Centres 784

Fixing Holes Sizes
Door 8mm, Glass 12mm

Specification Code
T8630 - 800 - H

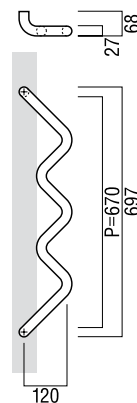
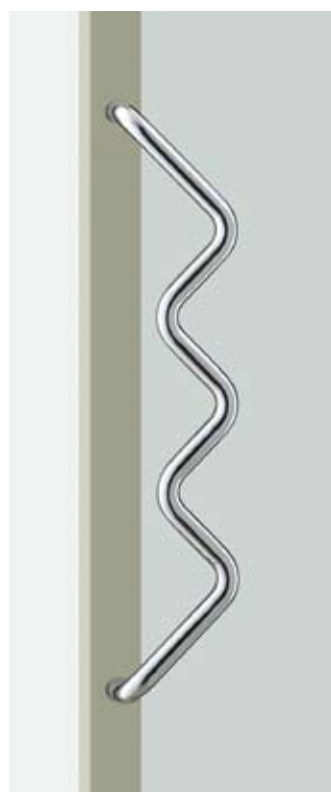

T2112

Base Material
Stainless Steel

Available Finish
Stainless Steel Polished (PS)

Available Sizes (mm)
Length 697, Centres 670

Fixing Holes Sizes
Door 10mm, Glass 16mm

Specification Code
T2112 - 697 - PS

MEDIUM ENTRY PULLS *by Elmes of Japan*

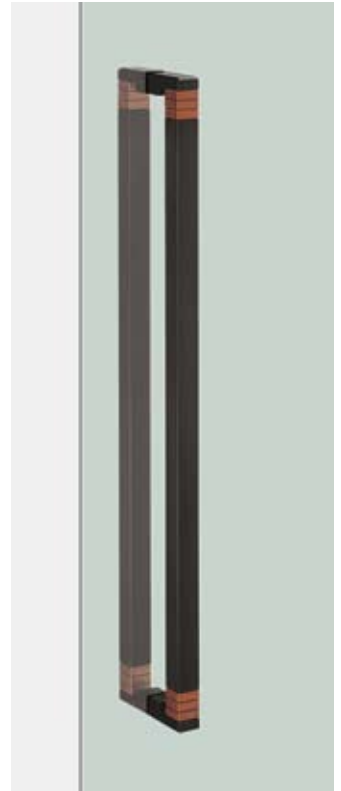
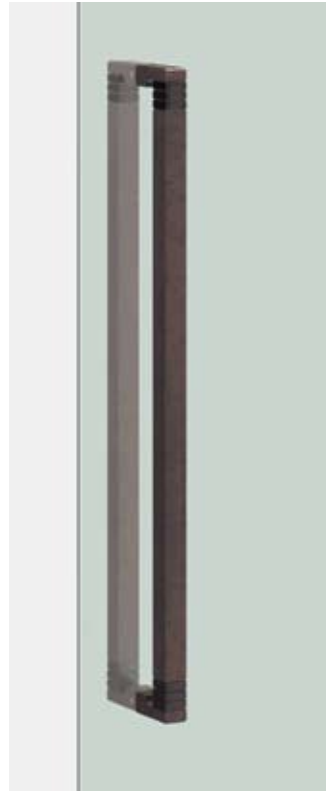
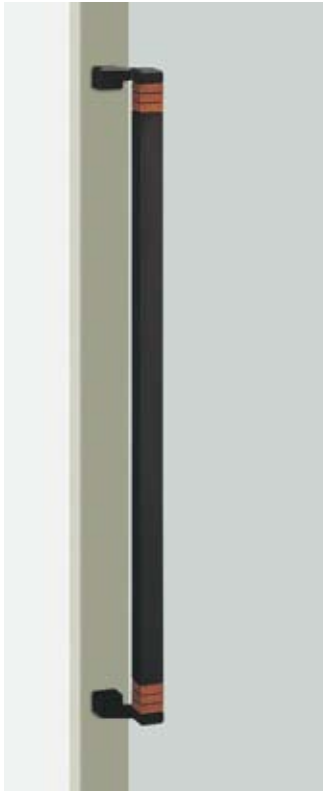

T2734

Base Material
Brass

Available Finish
Oxidized Black & Bright Bronze (B)
Chemically Treated Uneven Black & Purple-Black (P)

Available Sizes (mm)
Length 800, Centres 773.5

Fixing Holes Sizes
Door 10mm, Glass 16mm

Specification Code
T2734 - 800 - Finish

G2734

Base Material
Brass

Available Finish
Oxidized Black & Bright Bronze (B)
Chemically Treated Uneven Black & Purple-Black (P)

Available Sizes (mm)
Length 800, Centres 773.5

Fixing Holes Sizes
Door 10mm, Glass 16mm

Specification Code
G2734 - 800 - Finish

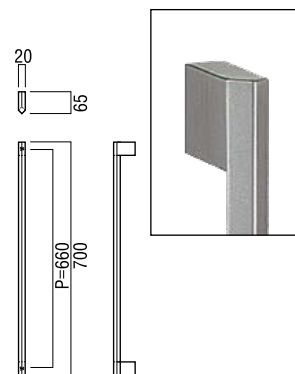
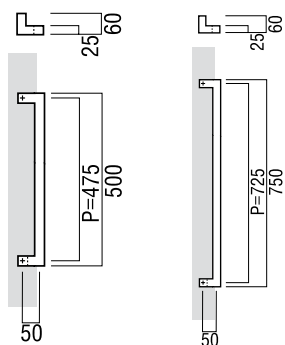
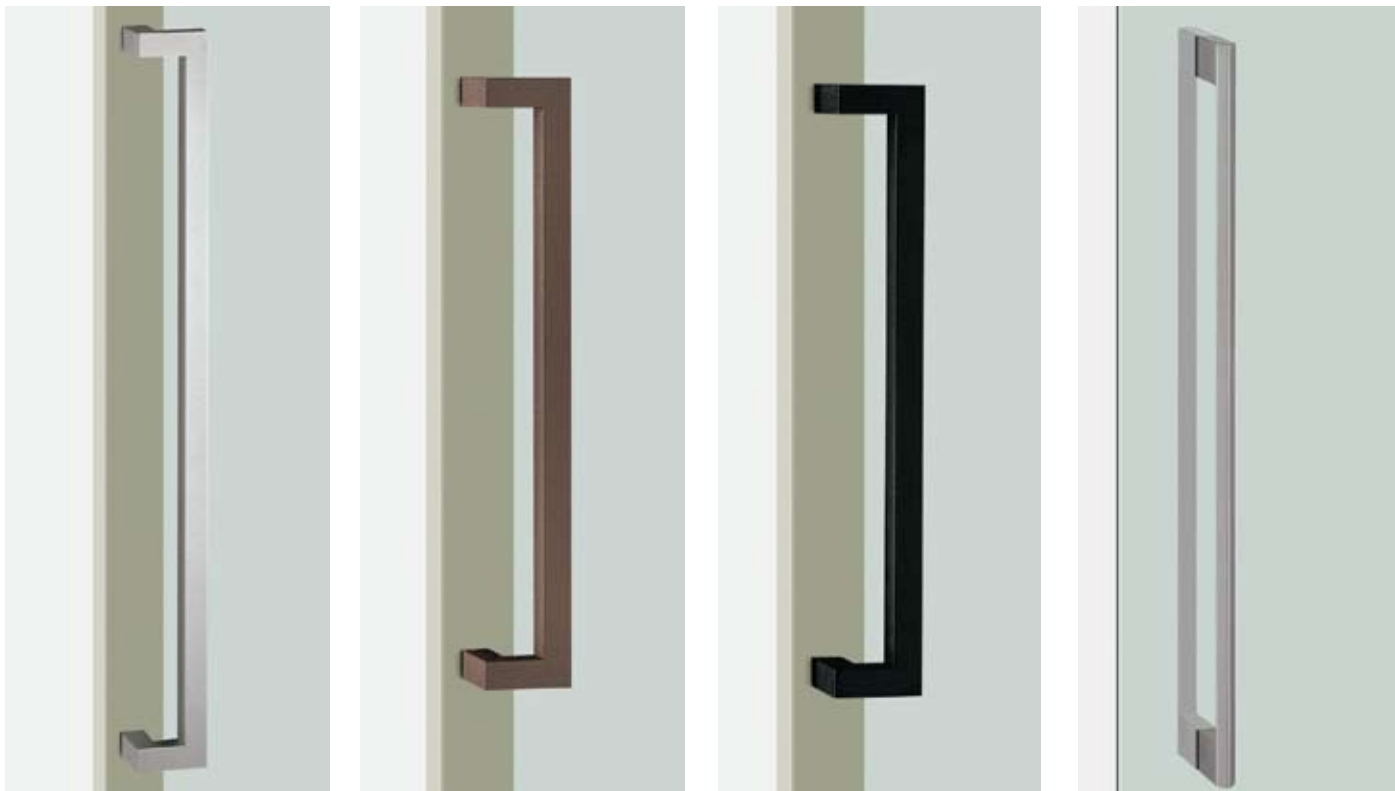

T1550

Base Material
Uni-Cast Aluminium

Available Finish
Blast Anodized Silver (S)
Blast Anodized Umber (U)
Blast Anodized Black (B)

Available Sizes (mm)
Length 750, Centres 725
Length 500, Centres 475

Fixing Holes Sizes
Door 10mm, Glass 16mm

Specification Code
T1550 - 750 - finish
T1550 - 500 - finish

G2327

Base Material
Stainless Steel

Available Finish
Hairline Stainless Steel (H)

Available Sizes (mm)
Length 700, Centres 660

Fixing Holes Sizes
Door 8mm, Glass 12mm

Specification Code
G2327 - 700 - H

MEDIUM ENTRY PULLS *by Elmes of Japan*

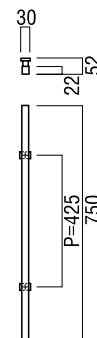
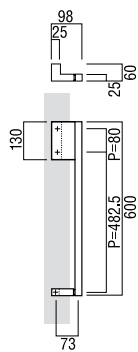
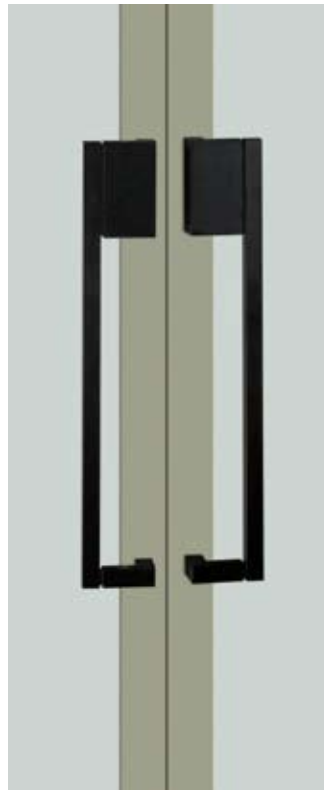
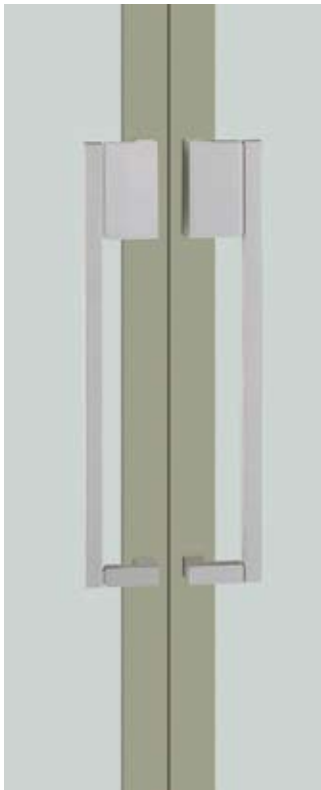

T9010

Base Material
Aluminium

Available Finish
Blast Anodized Silver (S)
Blast Anodized Black (B)

Available Sizes (mm)
Length 600, Centres 482.50

Fixing Holes Sizes
Door 10mm, Glass 16mm

Specification Code
T9010 - 600 - finish

T666

Base Material
Aluminium

Available Finish
Anodized Umber (U)

Available Sizes (mm)
Length 750, Centres 425

Fixing Holes Sizes
Door 8mm, Glass 12mm

Specification Code
T666 - 750 - U

G666

Base Material
Aluminium

Available Finish
Anodized Umber (U)

Available Sizes (mm)
Length 750, Centres 425

Fixing Holes Sizes
Door 8mm, Glass 12mm

Specification Code
G666 - 750 - U

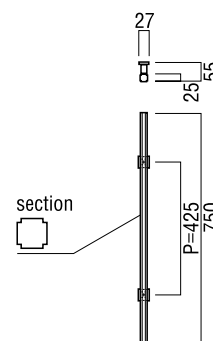
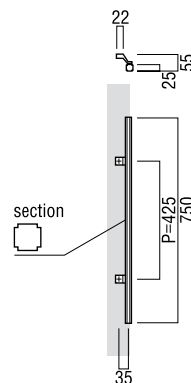
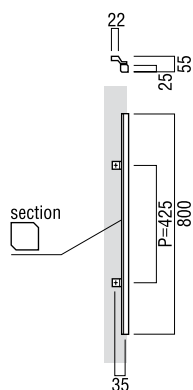

T665

Base Material
Aluminium

Available Finish
Anodized Silver (S)
Anodized Umber (U)

Available Sizes (mm)
Length 800, Centres 425

Fixing Holes Sizes
Door 8mm, Glass 12mm

Specification Code
T665 - 800 - finish

T690

Base Material
Aluminium

Available Finish
Anodized Black & Polished (B)

Available Sizes (mm)
Length 750, Centres 425

Fixing Holes Sizes
Door 8mm, Glass 12mm

Specification Code
T690 - 750 - B

G690

Base Material
Aluminium

Available Finish
Anodized Black & Polished (B)

Available Sizes (mm)
Length 750, Centres 425

Fixing Holes Sizes
Door 8mm, Glass 12mm

Specification Code
G690 - 750 - B

MEDIUM ENTRY PULLS *by Elmes of Japan*

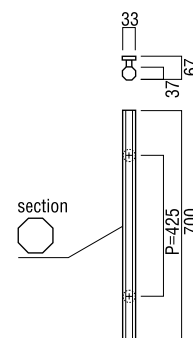
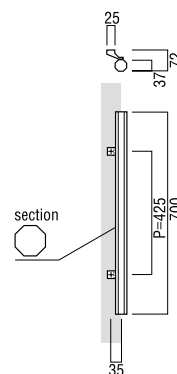
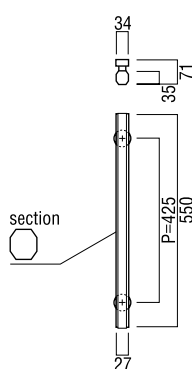
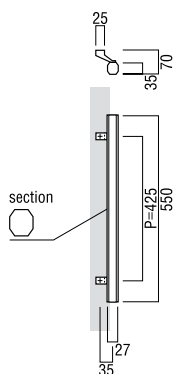
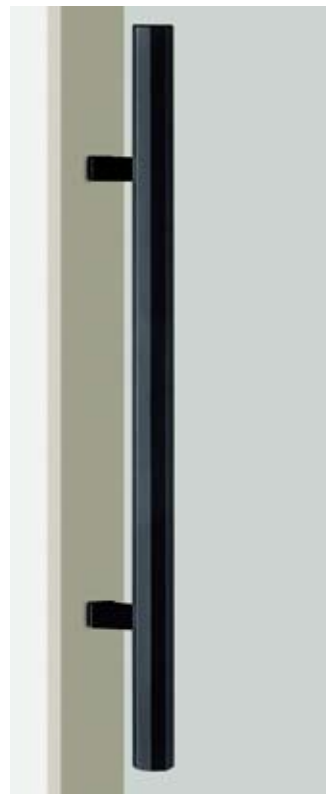
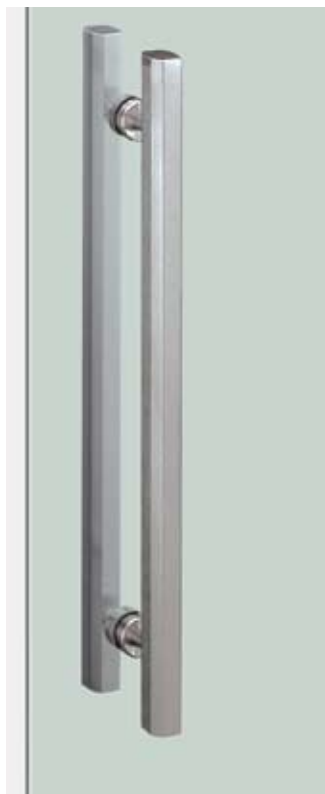
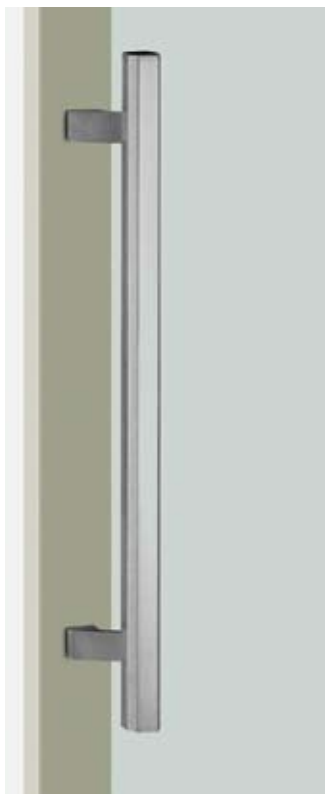

T330

Base Material
Stainless Steel

Available Finish
Hairline Stainless Steel (H)

Available Sizes (mm)
Length 550, Centres 425

Fixing Holes Sizes
Door 8mm, Glass 12mm

Specification Code
T330 - 700 - H

G330

Base Material
Stainless Steel

Available Finish
Hairline Stainless Steel (H)

Available Sizes (mm)
Length 550, Centres 425

Fixing Holes Sizes
Door 10mm, Glass 16mm

Specification Code
G330 - 550 - H

T380

Base Material
Copper

Available Finish
Oxidized, Black & Brass,
Oxidized Black legs (B)

Available Sizes (mm)
Length 700, Centres 425

Fixing Holes Sizes
Door 10mm, Glass 16mm

Specification Code
T380 - 700 - B

G380

Base Material
Copper

Available Finish
Oxidized, Black & Brass,
Oxidized Black legs (B)

Available Sizes (mm)
Length 700, Centres 425

Fixing Holes Sizes
Door 10mm, Glass 16mm

Specification Code
G380 - 700 - B

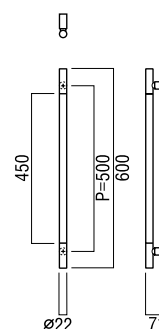
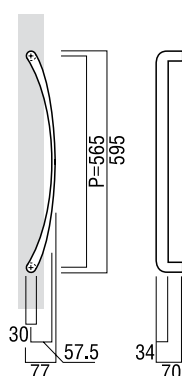
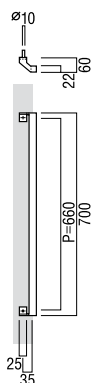
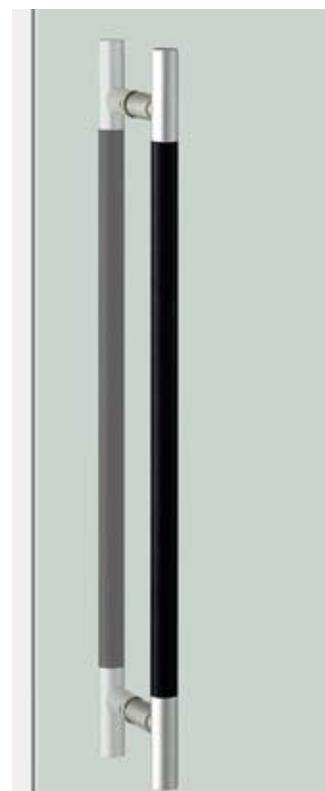
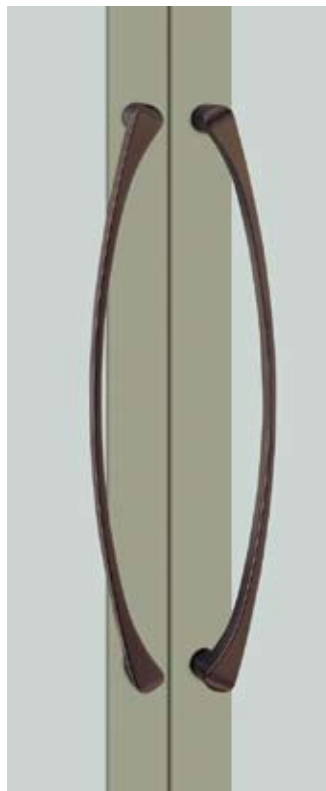
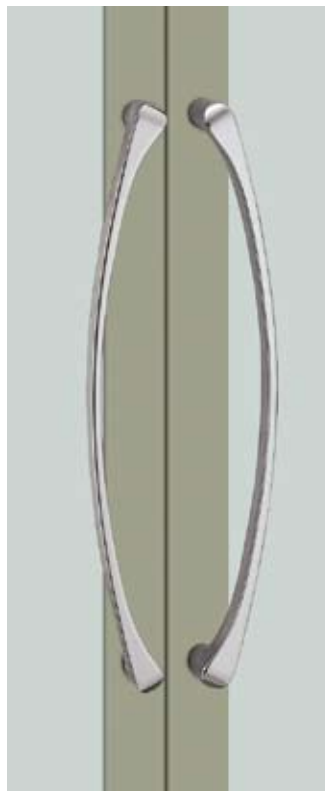
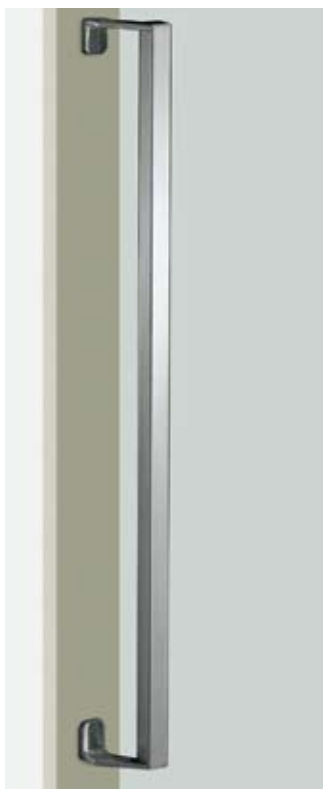

T670

Base Material
Stainless Steel

Available Finish
Hairline Stainless Steel (H)

Available Sizes (mm)
Length 700, Centres 660

Fixing Holes Sizes
Door
Ex Side Door 12mm
In Side Door 8mm
Glass
Glass 16mm

Specification Code
T670 - 700 - H

T6500

Base Material
Uni-Cast Aluminium

Available Finish
Anodized Silver (S)
Anodized Umber (U)

Available Sizes (mm)
Length 595, Centres 565

Fixing Holes Sizes
Door 10mm, Glass 16mm

Specification Code
T6500 - 595 - finish

G2690

Base Material
Uni-Frost Aluminium

Available Finish
Anodized Silver (S)
Blast Anodized Black & Uni-Frost
Anodized Silver (B)

Available Sizes (mm)
Length 600, Centres 500

Fixing Holes Sizes
Door 8mm, Glass 12mm

Specification Code
G2690 - 600 - finish

MEDIUM ENTRY PULLS *by Elmes of Japan*

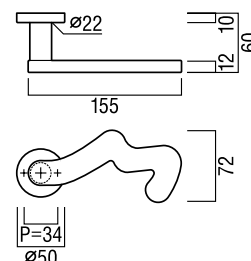
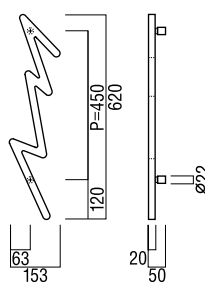
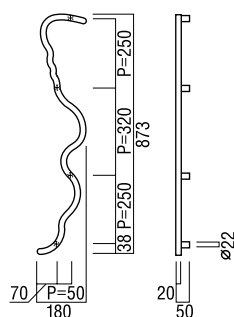
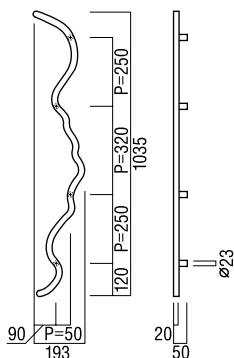

G3084

Base Material
Brass

Available Finish
Bright Chrome (CP)

Australian Handing
Australian Left Hand (L)
Australian Right Hand (R)

Available Sizes (mm)
Length 1035

Fixing Holes Sizes
Door 10mm, Glass 16mm

Specification Code
G3084 - 1035 - CP - L
G3084 - 1035 - CP - R

G3085

Base Material
Brass

Available Finish
Polished Brass (PB)

Australian Handing
Australian Left Hand (L)
Australian Right Hand (R)

Available Sizes (mm)
Length 873

Fixing Holes Sizes
Door 10mm, Glass 16mm

Specification Code
G3084 - 873 - PB - L
G3084 - 873 - PB - R

G3086

Base Material
Brass

Available Finish
Ceramic Baked Rose Red (R)

Australian Handing
Australian Left Hand (L)
Australian Right Hand (R)

Available Sizes (mm)
Length 620

Fixing Holes Sizes
Door 10mm, Glass 16mm

Specification Code
G3084 - 620 - R - L
G3084 - 620 - R - R

UL551

Base Material
Brass

Available Finish
Bright Chrome (CP)
Polished Brass (PB)
Ceramic Baked Rose Red (R)

Type
Lock Sets (L)
Passage Sets (P)
Privacy sets (PS)

Suitability
Internal & External Doors

Specification Code
UL551 - CP - Type
UL551 - PB - Type
UL551 - R - Type

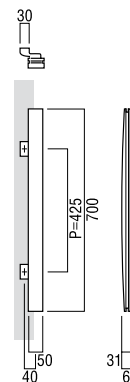
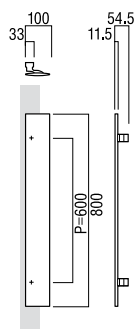
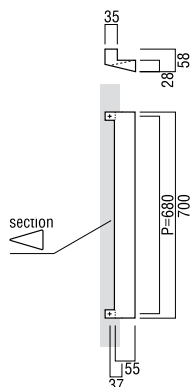
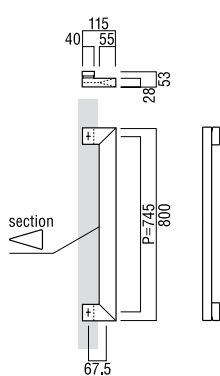
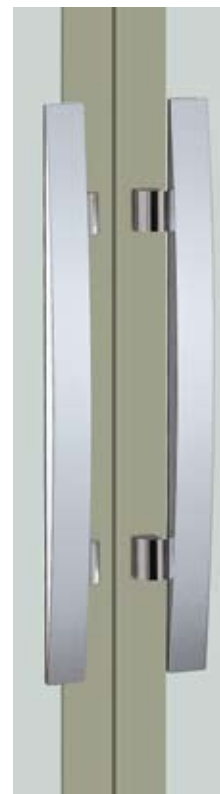

T3278

Base Material
Stainless Steel

Available Finish
Hairline & Polished
Stainless Steel (H)

Available Sizes (mm)
Length 800, Centres 745

Fixing Holes Sizes
Door 10mm, Glass 16mm

Specification Code
T3278 - 800 - H

T5656

Base Material
Aluminium

Available Finish
Anodized Black (B)

Available Sizes (mm)
Length 700, Centres 680

Fixing Holes Sizes
Door 10mm, Glass 16mm

Specification Code
T5656 - 700 - B

T2516

Base Material
Aluminium

Available Finish
Uni-Frost Anodized Silver (S)
Uni-Frost Anodized Stainless
Colour (SS)

Available Sizes (mm)
Length 800, Centres 600

Fixing Holes Sizes
Door 10mm, Glass 16mm

Specification Code
T2516 - 800 - S
T2516 - 800 - SS

T3026

Base Material
Aluminium & Stainless

Available Finish
Anodized Silver & Polished
Stainless legs (S)

Available Sizes (mm)
Length 700, Centres 425

Fixing Holes Sizes
Door 10mm, Glass 16mm

Specification Code
T3026 - 700 - S

MEDIUM ENTRY PULLS *by Elmes of Japan*

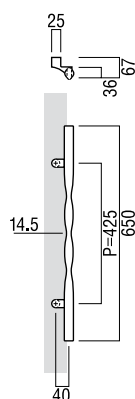
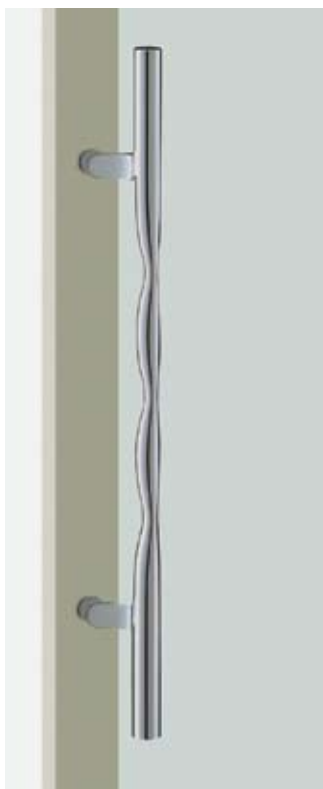

T2240

Base Material
Stainless Steel

Available Finish
Polished Stainless (P)

Available Sizes (mm)
Length 650, Centres 425

Fixing Holes Sizes
Door 10mm, Glass 16mm

Specification Code
T2240 - 650 - P

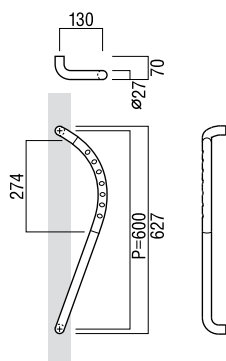
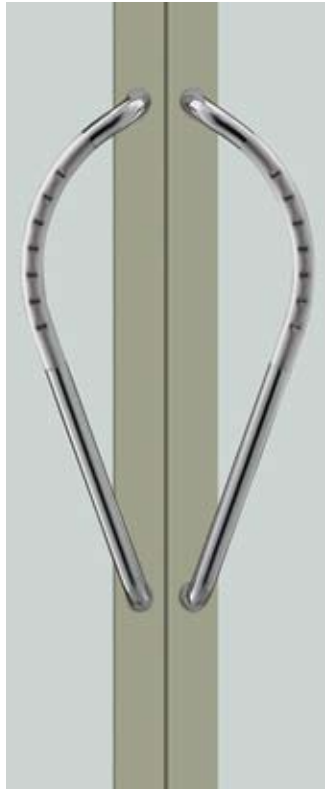

T9933

Base Material
Stainless Steel

Available Finish
Hairline & Polished Stainless (HP)

Australian Handing
Australian Left Hand (L)
Australian Right Hand (R)

Available Sizes (mm)
Length 627, Centres 600

Fixing Holes Sizes
Door 10mm, Glass 16mm

Specification Code
T9933 - 627 - HP - L
T9933 - 627 - HP - R



T3008

Base Material
Stainless Steel

Available Finish
Hairline + Polished Stainless
Steel (HP)

Available Sizes (mm)
Length 800, Centres 768
Length 600, Centres 568

Fixing Holes Sizes
Door 10mm, Glass 16mm

Specification Code
T3008 - 800 - HP
T3008 - 600 - HP

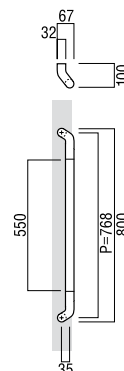
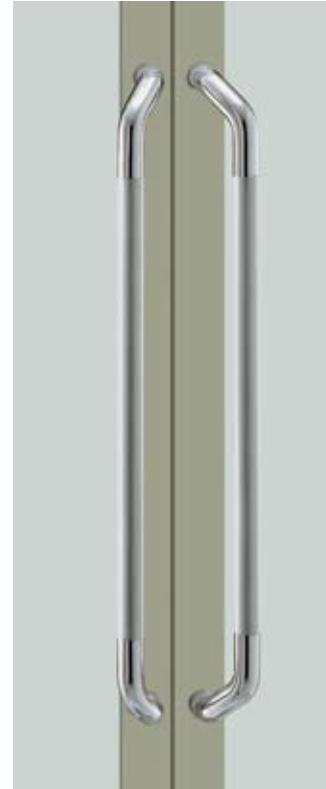

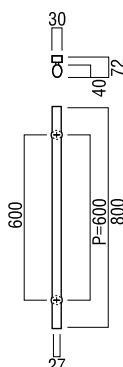
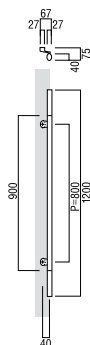
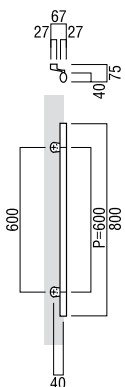
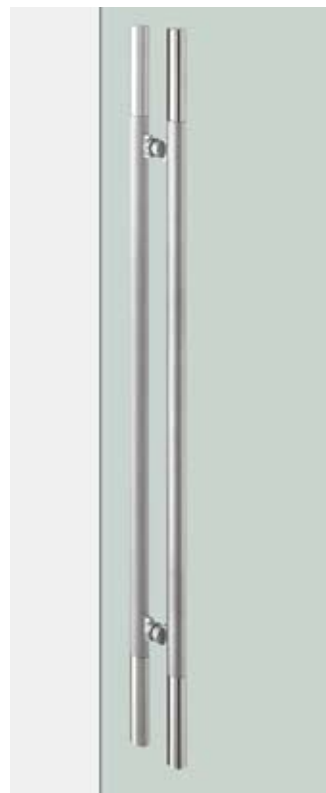
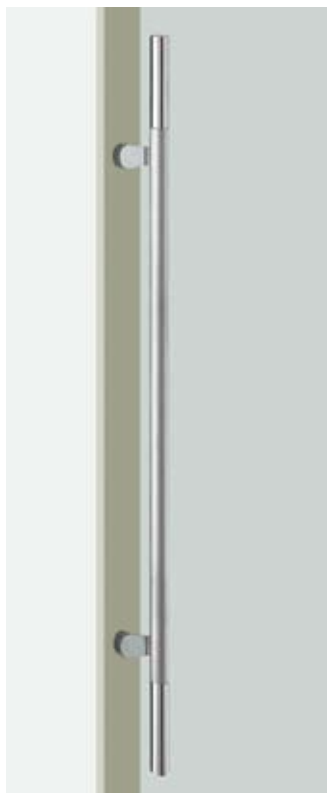
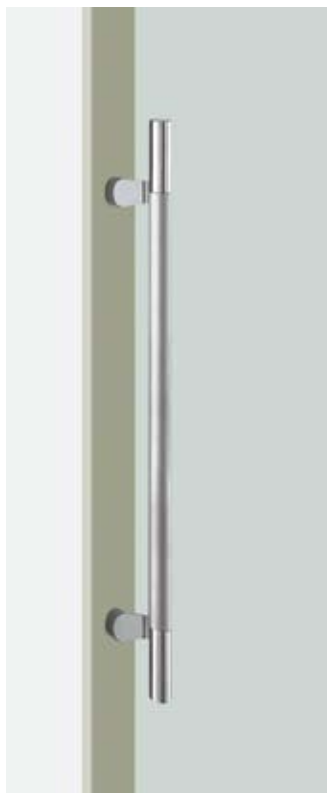

T5955

Base Material
Stainless Steel

Available Finish
Hairline & Polished Stainless (HP)

Available Sizes (mm)
Length 1200, Centres 800
Length 800, Centres 600

Fixing Holes Sizes
Door 10mm, Glass 16mm

Specification Code
T5955 - 1200 - HP
T5955 - 800 - HP

G5955

Base Material
Stainless Steel

Available Finish
Hairline & Polished Stainless (HP)

Available Sizes (mm)
Length 1200, Centres 800
Length 800, Centres 600

Fixing Holes Sizes
Door 10mm, Glass 16mm

Specification Code
G5955 - 1200 - HP
G5955 - 800 - HP

MEDIUM ENTRY PULLS *by Elmes of Japan*

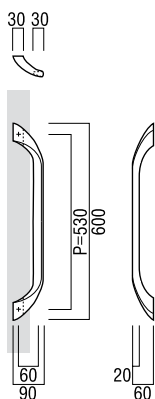

T6510

Base Material
Uni-Cast Aluminium

Available Finish
Blast Anodized Silver (S)
Blast Anodized Black (B)

Australian Handing
Length 600, Centres 530

Fixing Holes Sizes
Door 10mm, Glass 16mm

Specification Code
T6510 - 600 - finish

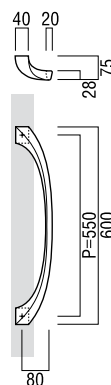

T6515

Base Material
Uni-Cast Aluminium

Available Finish
Blast Anodized Silver (S)
Blast Anodized Black (B)

Australian Handing
Length 600, Centres 550

Fixing Holes Sizes
Door 10mm, Glass 16mm

Specification Code
T6515 - 600 - finish

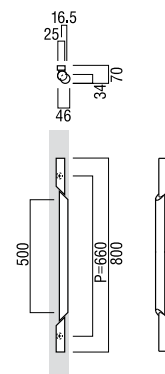
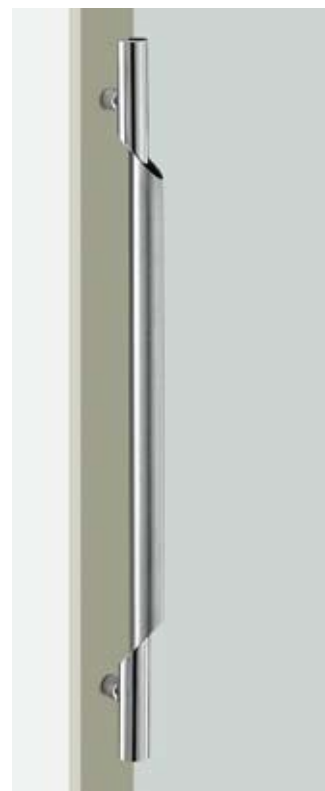
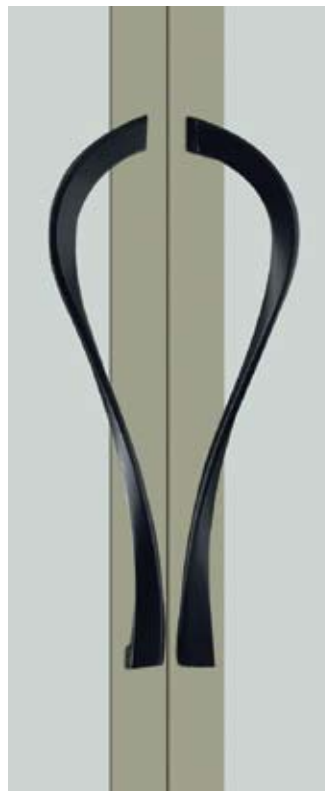

T1780

Base Material
Uni-Cast Aluminium

Available Finish
Blast Anodized Silver (S)
Blast Anodized Pale Gold (G)
Blast Anodized Black (B)

Australian Handing
Australian Left Hand (L)
Australian Right Hand (R)

Available Sizes (mm)
Length 610, Centres 570

Fixing Holes Sizes
Door 10mm

Specification Code
T1780 - 610 - finish - L
T1780 - 610 - finish - R
Note: Not Suitable for Glass
Doors

T3053

Base Material
Stainless Steel

Available Finish
Brushed Stainless & Polished
Stainless Steel (BPS)

Available Sizes (mm)
Length 800, Centres 660

Fixing Holes Sizes
Door 10mm, Glass 16mm

Specification Code
T3053 - 800 - BPS

MEDIUM ENTRY PULLS *by Elmes of Japan*

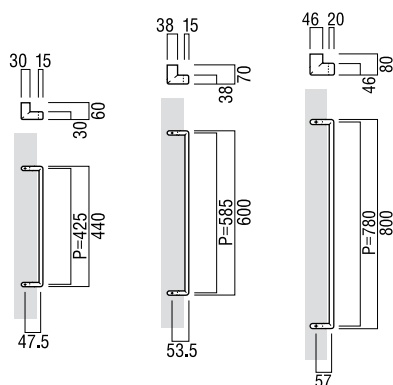
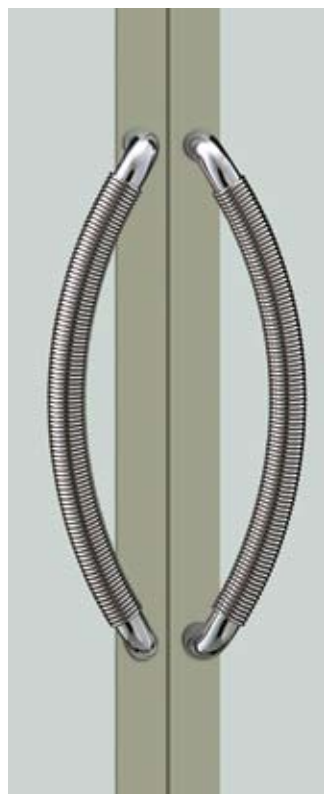

T5350

Base Material
Stainless Steel

Available Finish
Polished Stainless Steel (PS)

Available Sizes (mm)
Length 800, Centres 780
Length 600, Centres 585
Length 440, Centres 425

Fixing Holes Sizes
Door 8mm, Glass 12mm

Specification Code
T5350 - 800 - PS
T5350 - 600 - PS
T5350 - 440 - PS

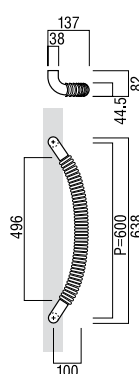

T7210

Base Material
Stainless Steel

Available Finish
Polished Stainless (P)

Available Sizes (mm)
Length 638, Centres 600

Fixing Holes Sizes
Door 10mm, Glass 16mm

Specification Code
T7210 - 638 - P

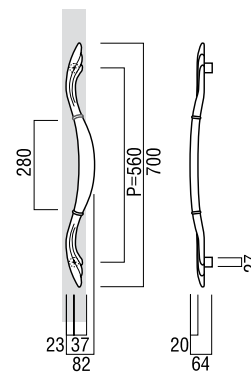

T3105

Base Material
Brass

Available Finish
Chrome with Polished
Brass (CPB)

Available Sizes (mm)
Length 700, Centres 560

Fixing Holes Sizes
Door 10mm, Glass 16mm

Specification Code
T3105 - 700 - CPB

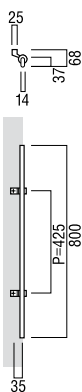

T5270

Base Material
Stainless Steel

Available Finish
Polished Stainless Steel (P)

Available Sizes (mm)
Length 800, Centres 425

Fixing Holes Sizes
Door 8mm, Glass 12mm

Specification Code
T5270 - 800 - P

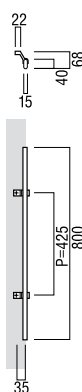

T5270

Base Material
Aluminium

Available Finish
Anodized Aluminium Silver (S)
Anodized Aluminium Umber (U)

Available Sizes (mm)
Length 800, Centres 425

Fixing Holes Sizes
Door 8mm, Glass 12mm

Specification Code
T5270 - 800 - P

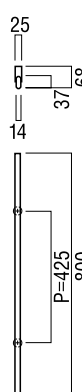

G5270

Base Material
Stainless Steel

Available Finish
Polished Stainless Steel (P)

Available Sizes (mm)
Length 800, Centres 425

Fixing Holes Sizes
Door 10mm, Glass 16mm

Specification Code
G5270 - 800 - P

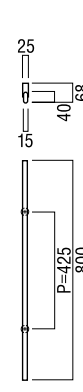

G5270

Base Material
Aluminium

Available Finish
Anodized Aluminium Silver (S)
Anodized Aluminium Umber (U)

Available Sizes (mm)
Length 800, Centres 425

Fixing Holes Sizes
Door 10mm, Glass 16mm

Specification Code
G5270 - 800 - P

MEDIUM ENTRY PULLS *by Elmes of Japan*

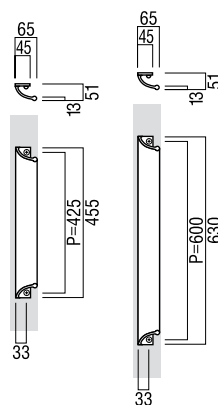
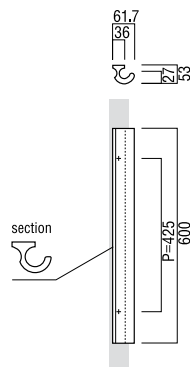
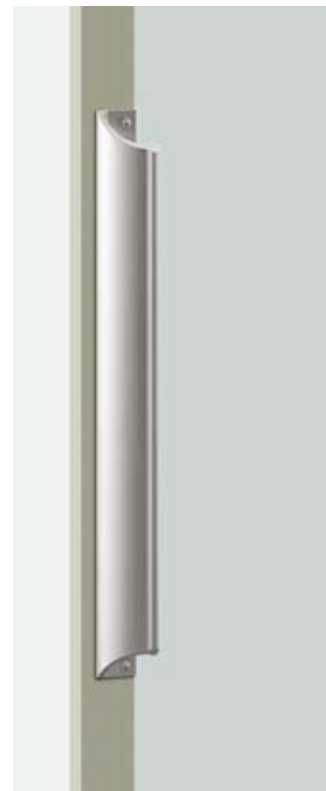
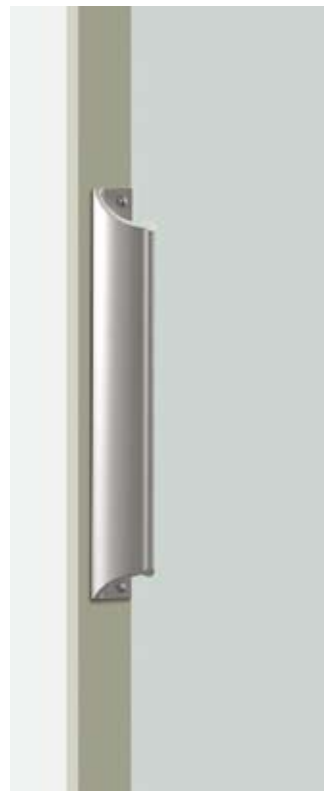

T2306

Base Material
Uni-Cast Aluminium

Available Finish
Anodized Silver & Blast Anodized Silver (SBS)

Australian Handing
Australian Left Hand (L)
Australian Right Hand (R)

Available Sizes (mm)
Length 732, Centres 650

Fixing Holes Sizes
Door 8mm

Specification Code
T2306 - 732 - SBS - L
T2306 - 732 - SBS - R

T5500

Base Material
Aluminium

Available Finish
Anodized Stainless Steel Colour (ASS)

Available Sizes (mm)
Length 600, Centres 425

Fixing Holes Sizes
Door 10mm, Glass 16mm

Specification Code
T5500 - 600 - ASS

T8038

Base Material
Aluminium

Available Finish
Anodized Silver (S)

Available Sizes (mm)
Length 630, Centres 600
Length 455, Centres 425

Fixing Holes Sizes
Door 8mm, Glass 12mm

Specification Code
T8038 - 630 - S
T8038 - 455 - S



G2508

Base Material
Uni-Cast Aluminium

Available Finish
Anodized Silver & Blast Anodized Silver (S)
Anodized Silver & Anodized Black (B)

Available Sizes (mm)
Length 780, Centres 600

Fixing Holes Sizes
Door 10mm, Glass 16mm

Specification Code
G2508 - 780 - finish

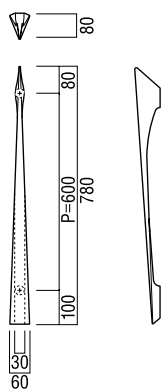

T2304

Base Material
Brass

Available Finish
Bright Chrome (BC)
Hairline Brass & Polished Brass (B)

Available Sizes (mm)
Length 600, Centres 450

Fixing Holes Sizes
Door 10mm, Glass 16mm

Specification Code
T2304 - 600 - finish

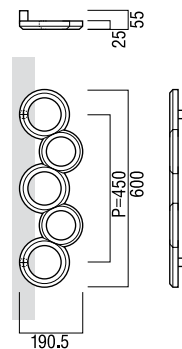

MEDIUM ENTRY PULLS *by Elmes of Japan*

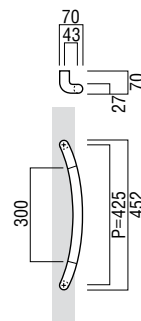
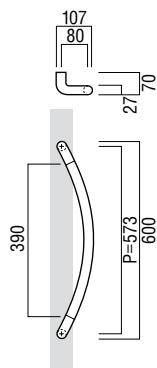
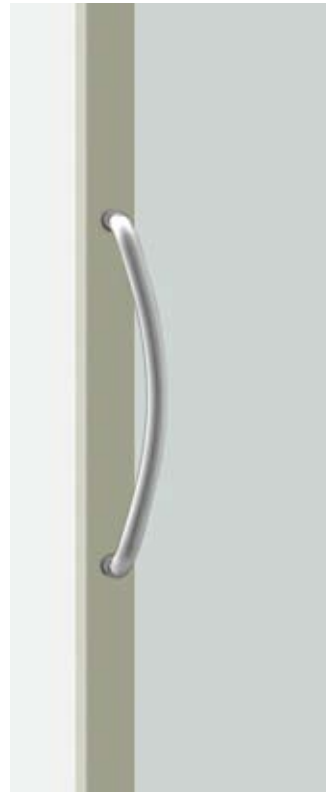
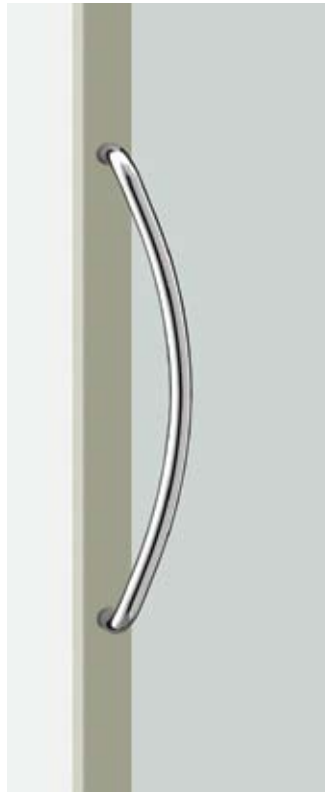
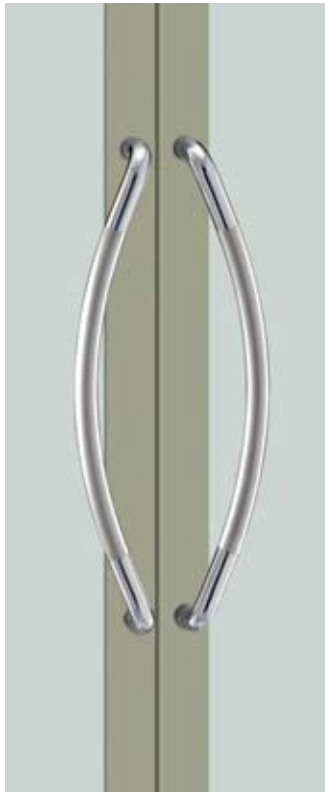

T6010

Base Material
Stainless Steel

Available Finish
Hairline Stainless (H)
Polished Stainless (PS)
Hairline & Polished Stainless (HP)

Available Sizes (mm)
Length 600, Centres 573

Fixing Holes Sizes
Door 10mm, Glass 16mm

Specification Code
T6010 - 600 - finish

T6010

Base Material
Stainless Steel

Available Finish
Hairline Stainless (H)
Polished Stainless (PS)
Hairline & Polished Stainless (HP)

Available Sizes (mm)
Length 452, Centres 425

Fixing Holes Sizes
Door 10mm, Glass 16mm

Specification Code
T6010 - 452 - finish

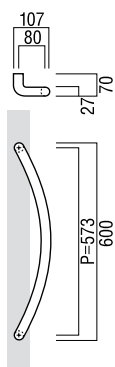

T6010

Base Material
Stainless Steel

Available Finish

- Uni-Cera (Baked Finish) White (W)
- Uni-Cera (Baked Finish) Yellow (Y)
- Uni-Cera (Baked Finish) Red (R)
- Uni-Cera (Baked Finish) Green (G)
- Uni-Cera (Baked Finish) Sepia (S)
- Uni-Cera (Baked Finish) Black (B)

Available Sizes (mm)

Length 600, Centres 573

Fixing Holes Sizes

Door 10mm, Glass 16mm

Specification Code

T6010 - 600 - finish

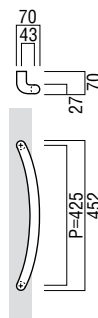

T6010

Base Material
Acrylic

Available Finish

- Acrylic Clear Transparent (C)
- Acrylic Plastic White (W)
- Acrylic Plastic Yellow (Y)
- Acrylic Plastic Green (G)
- Acrylic Plastic Red (R)
- Acrylic Plastic Black (B)

Available Sizes (mm)

Length 452, Centres 425

Fixing Holes Sizes

Door 10mm, Glass 16mm

Specification Code

T6010 - 455- finish

MEDIUM ENTRY PULLS *by Elmes of Japan*

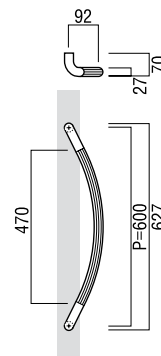
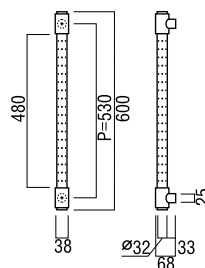
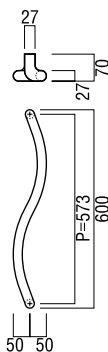
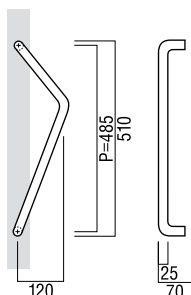
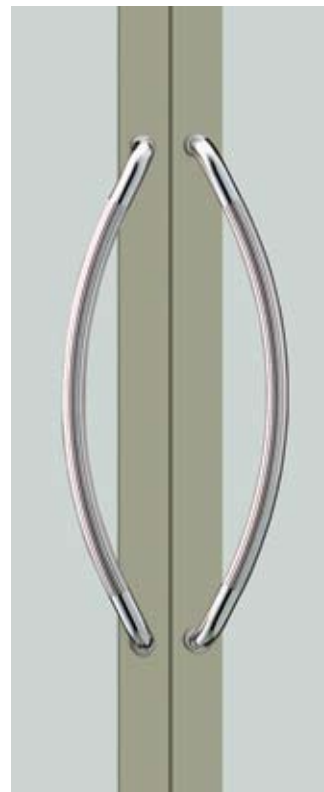
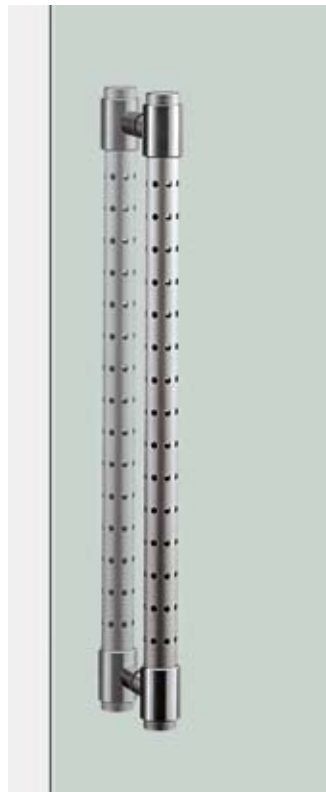
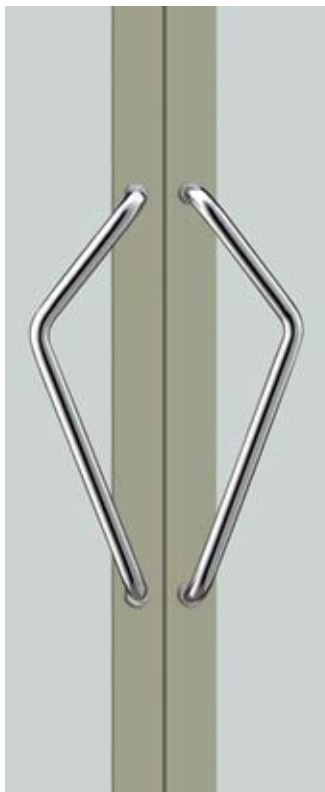

T5120

Base Material
Stainless Steel

Available Finish
Polished Stainless (P)

Available Sizes (mm)
Length 510, Centres 485

Fixing Holes Sizes
Door 10mm, Glass 16mm

Specification Code
T5120 - 510 - P

G2054

Base Material
Stainless Steel

Available Finish
Hairline Stainless (H)
Polished Stainless (P)

Available Sizes (mm)
Australian Left Hand (L)
Australian Right Hand (R)

Fixing Holes Sizes
Length 600, Centres 573

Fixing Holes Sizes
Door 10mm, Glass 16mm

Specification Code
G2054 - 600 - finish - L
G2054 - 600 - finish - R

G3075

Base Material
Stainless Steel

Available Finish
Hairline and Polished Steel (HP)

Available Sizes (mm)
Length 600, Centres 530

Fixing Holes Sizes
Door 10mm, Glass 16mm

Specification Code
G3075 - 600 - HP

T3067

Base Material
Stainless Steel

Available Finish
Polished Stainless (P)

Available Sizes (mm)
Length 627, Centres 600

Fixing Holes Sizes
Door 10mm, Glass 16mm

Specification Code
T3067 - 627 - P

MEDIUM ENTRY PULLS *by Elmes of Japan*

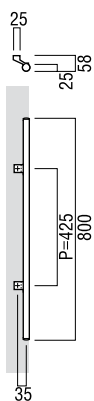

T720

Base Material
Stainless Steel, Brass

Available Finish
Hairline Stainless Steel (H)
Polished Stainless Steel (P)
Polished Brass (BR)

Available Sizes (mm)
Length 800, Centres 425

Fixing Holes Sizes
Door 8mm, Glass 12mm

Specification Code
T720 - 800 - finish

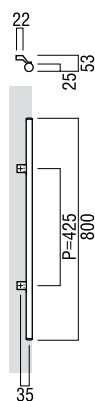

T720

Base Material
Aluminium

Available Finish
Anodized Umber (U)
Anodized Black (B)

Available Sizes (mm)
Length 800, Centres 425

Fixing Holes Sizes
Door 8mm, Glass 12mm

Specification Code
T720 - 800 - finish

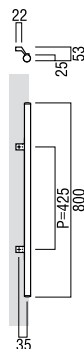

T720

Base Material
Uniwood (Antibacterial
Compressed Wood) and
Aluminium

Available Finish
Uni-Wood Brown and Anodized
Umber (UB)

Available Sizes (mm)
Length 800, Centres 425

Fixing Holes Sizes
Door 8mm, Glass 12mm

Specification Code
T720 - 800 - UB

MEDIUM ENTRY PULLS *by Elmes of Japan*

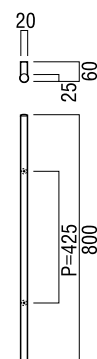
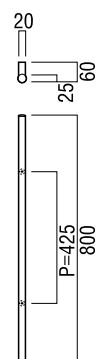
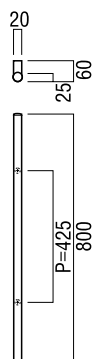

G720

Base Material
Stainless Steel, Brass

Available Finish
Polished Stainless (P)
Hairline Stainless (H)
Polished Brass (PB)

Available Sizes (mm)
Length 800, Centres 425

Fixing Holes Sizes
Door 8mm, Glass 12mm

Specification Code
G720 - 800 - finish

G720

Base Material
Aluminium

Available Finish
Anodized Umber (U)
Anodized Black (B)

Available Sizes (mm)
Length 800, Centres 425

Fixing Holes Sizes
Door 8mm, Glass 12mm

Specification Code
G720 - 800 - finish

G720

Base Material
Uniwood (Antibacterial
Compressed Wood) and
Stainless Steel

Available Finish
Uni-Wood Brown and Polished
Stainless Steel (PS)

Available Sizes (mm)
Length 800, Centres 425

Fixing Holes Sizes
Door 8mm, Glass 12mm

Specification Code
G720 - 800 - PS

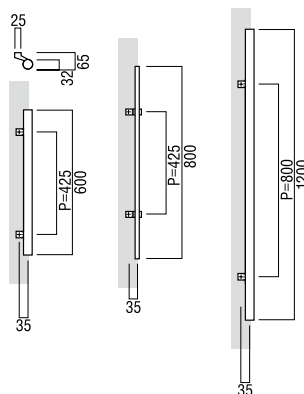
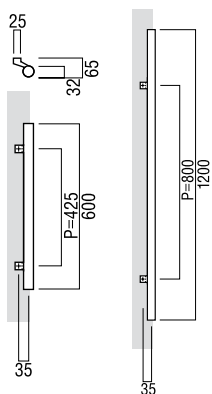
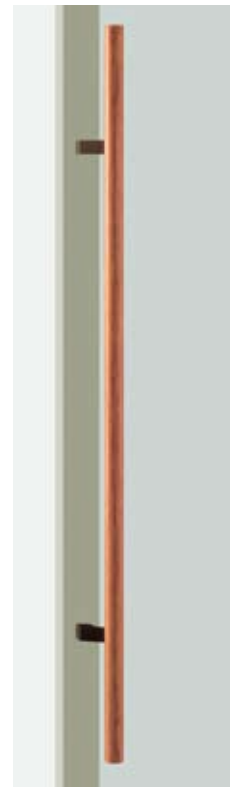
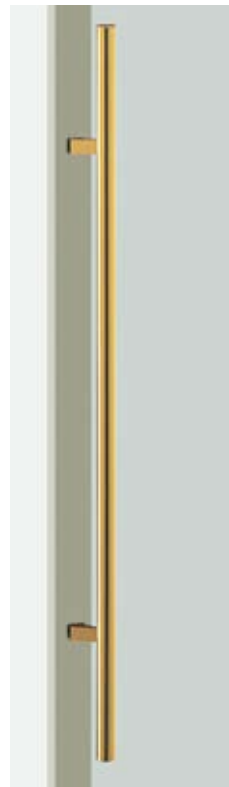
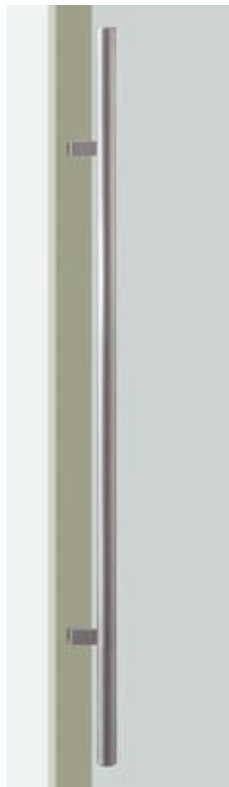
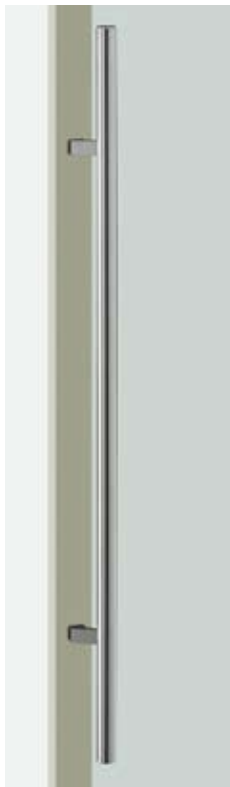

T52

Base Material
Stainless Steel, Brass

Available Finish
Hairline Stainless Steel (H)
Polished Stainless Steel (PS)
Polished Brass (PB)

Available Sizes (mm)
Length 1200, Centres 800
Length 600, Centres 425

Fixing Holes Sizes
Door 8mm, Glass 12mm

Specification Code
T52 - 1200 - finish
T52 - 600 - finish

T52

Base Material
Uniwood (Antibacterial
Compressed Wood) and
Aluminium

Available Finish
Uni-Wood Brown and Brass
Oxidized Brown Legs (B)

Available Sizes (mm)
Length 1200, Centres 800
Length 800, Centres 425
Length 600, Centres 425

Fixing Holes Sizes
Door 8mm, Glass 12mm

Specification Code
T52 - 1200 - B
T52 - 800 - B
T52 - 600 - B

MEDIUM ENTRY PULLS *by Elmes of Japan*

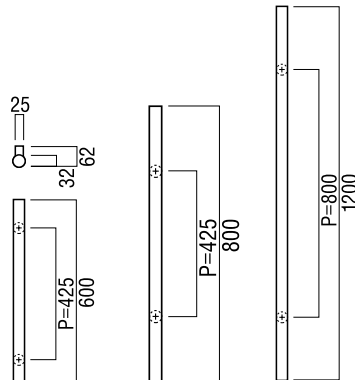
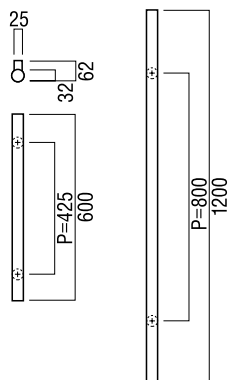

G52

Base Material
Stainless Steel, Brass

Available Finish
Hairline Stainless Steel (H)
Polished Stainless (P)
Polished Brass (PB)

Available Sizes (mm)
Length 1200, Centres 800
Length 600, Centres 425

Fixing Holes Sizes
Door 10mm, Glass 16mm

Specification Code
G52 - 1200 - finish
G52 - 600 - finish

G52

Base Material
Uniwood (Antibacterial
Compressed Wood) and
Stainless Steel

Available Finish
Uni-Wood Brown and Hairline
Stainless Steel Legs (B)

Available Sizes (mm)
Length 1200, Centres 800
Length 800, Centres 425
Length 600, Centres 425

Fixing Holes Sizes
Door 10mm, Glass 16mm

Specification Code
G52 - 1200 - B
G52 - 800 - B
G52 - 600 - B

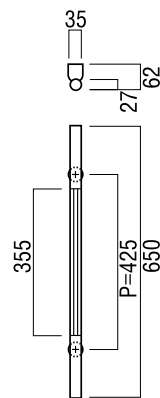
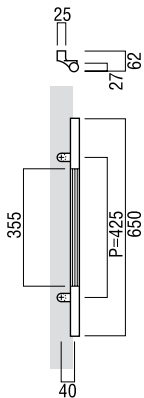
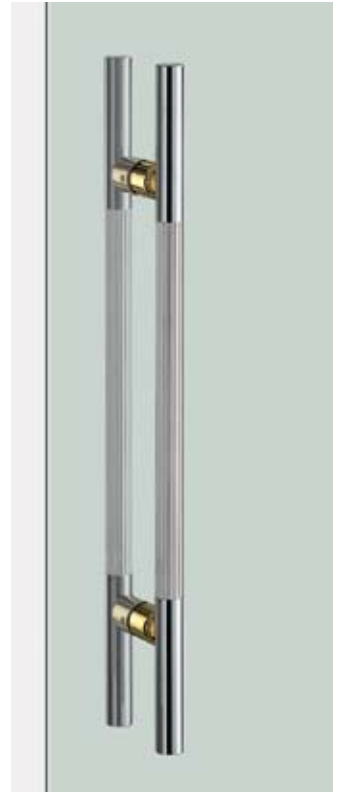
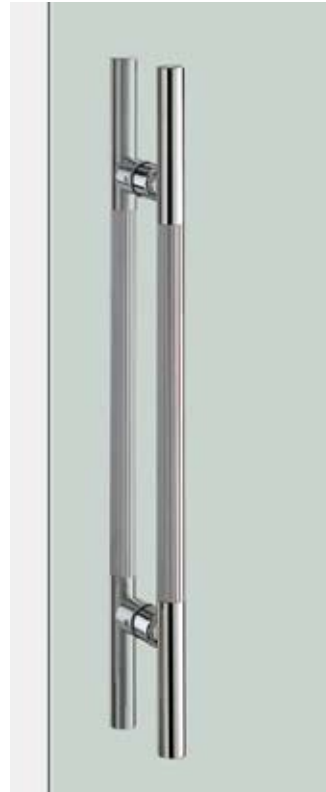
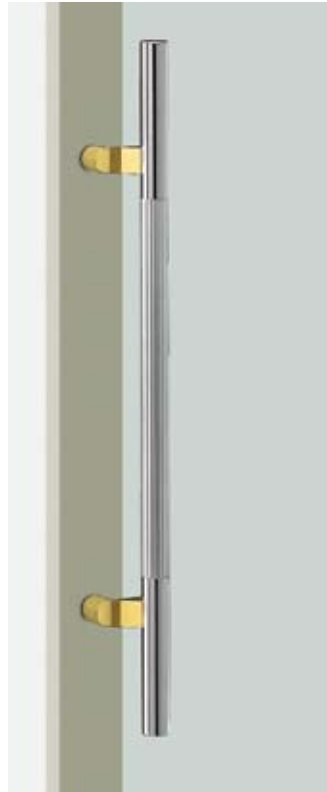
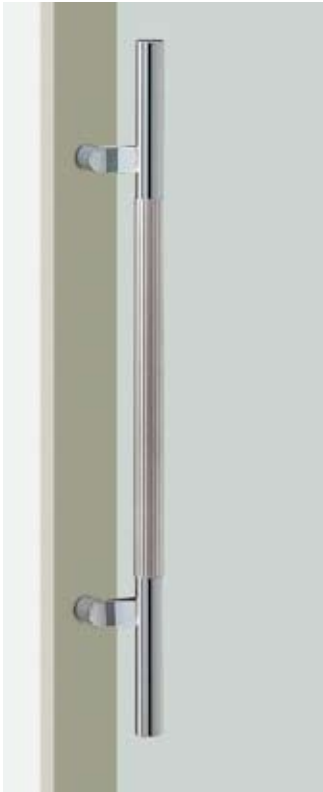

T573

Base Material

Stainless Steel, Stainless Steel & Brass

Available Finish

Hairline and Polished Stainless Steel (H)
Hairline and Polished Stainless Steel & Polished Brass
Legs (B)

Available Sizes (mm)

Length 650, Centres 425

Fixing Holes Sizes

Door 10mm, Glass 16mm

Specification Code

T573 - 650 - finish

G573

Base Material

Stainless Steel, Stainless Steel & Brass

Available Finish

Hairline and Polished Stainless Steel (H)
Hairline and Polished Stainless Steel & Polished Brass
Legs (B)

Available Sizes (mm)

Length 650, Centres 425

Fixing Holes Sizes

Door 10mm, Glass 16mm

Specification Code

G573 - 650 - finish



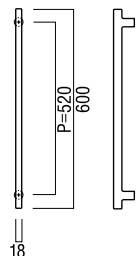
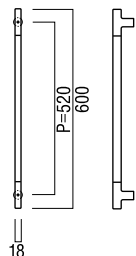
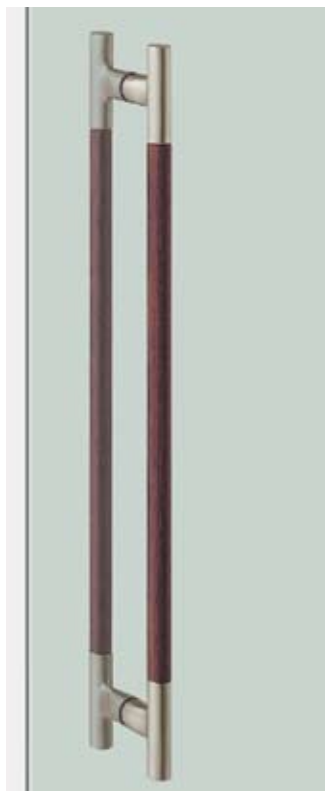
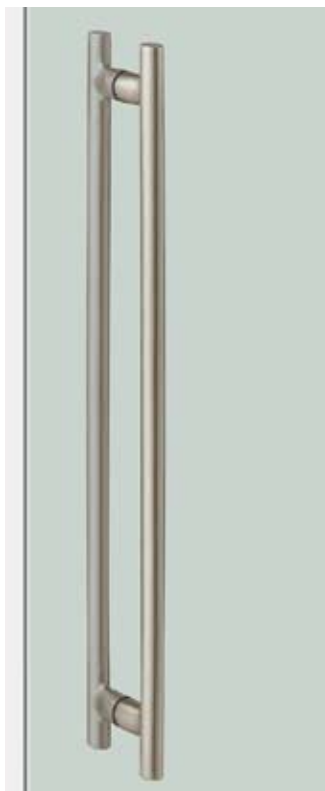

G777

Base Material
Uni-Cast Aluminium

Available Finish
Hairline Anodized Stainless Steel Colour (S)

Available Sizes (mm)
Length 600, Centres 520

Fixing Holes Sizes
Door 8mm, Glass 12mm

Specification Code
G777 - 600 - S

G777

Base Material
Uniwood (Antibacterial Compressed Wood) with Uni-Cast Aluminium

Available Finish
Uni-Wood Mahogany and Anodized Stainless Steel Colour (M)
Black Leather and Anodized Stainless Steel Colour (B)

Available Sizes (mm)
Length 600, Centres 520

Fixing Holes Sizes
Door 8mm, Glass 12mm

Specification Code
G777 - 600 - finish



A series in which total collaboration of the materials can be enjoyed

The silver part is distinctively elegant Stainless Steel hairline finish. The black grip is aluminium, and the white and brown grips are outstandingly durable Uni-Wood. A series that is a novel accent to the space in which the collaboration of different materials produces a modern impression. The entry pull is available in a range of lengths to suite any space. Lever handles of the same design are also available, allowing for a complete coordination of the space.

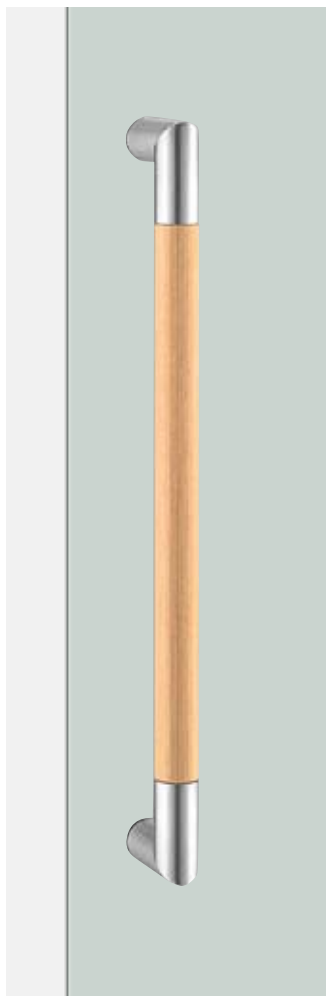

G2750

Base Material

Stainless Steel, Stainless Steel & Uniwood (Antibacterial Compressed Wood)

Available Finish

Stainless Steel Hairline (S)
Uni-Wood Light White & Stainless Steel Hairline (W)
Uni-Wood Scotch Colour & Stainless Steel Hairline (SC)

Available Sizes (mm)

Length 452, Centres 425
Length 600, Centres 573

Fixing Holes Sizes

Door 10mm, Glass 16mm

Specification Code

G2750 - 425 - (finish)
G2750 - 600 - (finish)
G2751 - 1300 - (finish)

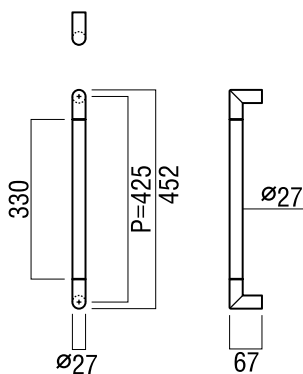

G2750

Base Material

Aluminium & Stainless Steel

Available Finish

Aluminium Blast Anodized Black & Stainless Steel Hairline (AB)

Available Sizes (mm)

Length 452, Centres 425
Length 600, Centres 573

Fixing Holes Sizes

Door 10mm, Glass 16mm

Specification Code

G2750 - 425 - AB
G2750 - 600 - AB
G2751 - 1300 - AB

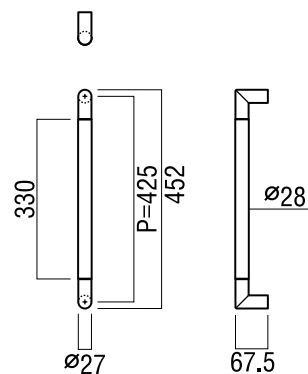

The image shows two vertical wooden door pulls against a dark grey wall. Each pull consists of a vertical rectangular wooden post and a horizontal cylindrical handle. The top pull has a reddish-brown wood grain, while the bottom pull has a darker, more uniform wood grain. The lighting is dramatic, highlighting the textures and edges of the wood.

Enhance a modern room nonchalantly with elegant timber stripes.

The pattern of vertical lines created by laminating coloured natural wood makes this entry pull unique. In addition, the back of the handle is rounded allowing it to conform well to the hand. The T2890 is an example of how it is possible to increase the stylishness of commercial architecture.

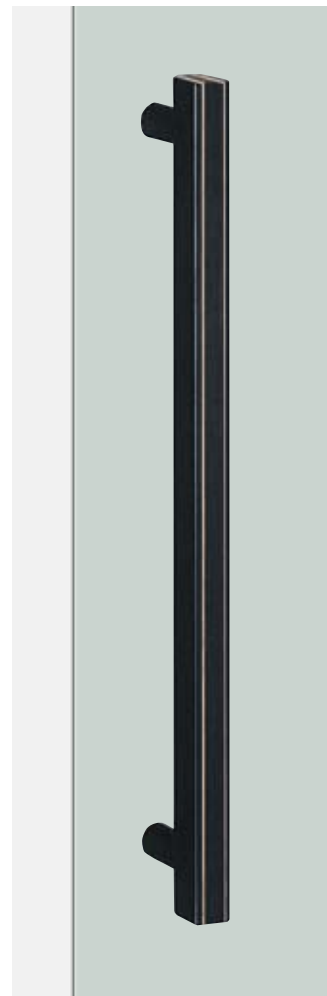
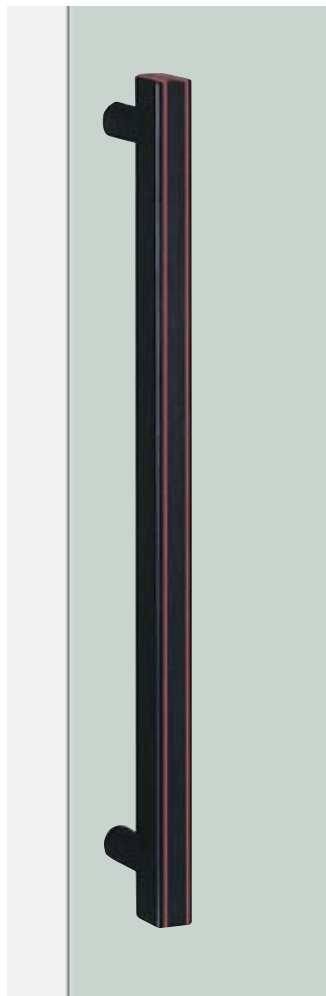
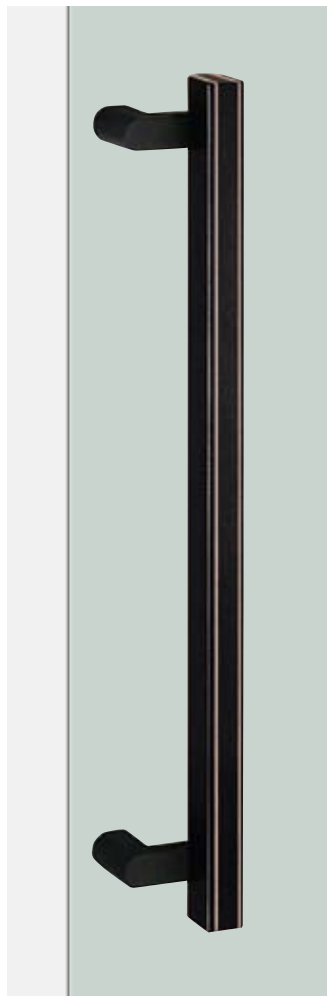
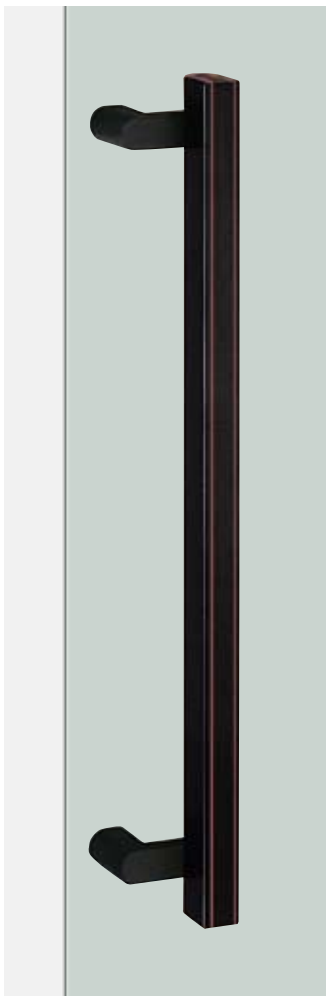

T2890

Base Material
Uniwood (Antibacterial
Compressed timber) & Aluminium

Available Finish
Black and White timber with Blast
Anodized Black legs (B)
Black and Red timber with Blast
Anodized Black legs (R)

Available Sizes (mm)
Length 460, Centres 400
Length 600, Centres 540

Fixing Holes Sizes
Door 8mm, Glass 12mm

Specification Code
T2890 - 460 - finish
T2890 - 600 - finish

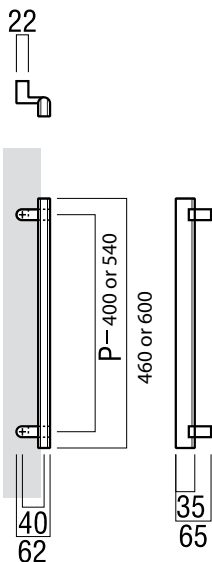

G2890

Base Material
Uniwood (Antibacterial
Compressed timber) & Aluminium

Available Finish
Black and White timber with Blast
Anodized Black legs (B)
Black and Red timber with Blast
Anodized Black legs (R)

Available Sizes (mm)
Length 460, Centres 400
Length 600, Centres 540

Fixing Holes Sizes
Door 8mm, Glass 12mm

Specification Code
G2890 - 460 - finish
G2890 - 600 - finish

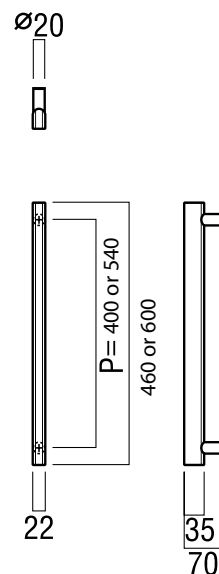

The warmth of wood and round form of Tender Line lends tenderness to the space.

Tender Line is a Door Handle series that can be used in a wide range of locations, such as welfare facilities, kindergartens and facilities for children. Can be gripped securely. The plywood surface is pleasant to the touch. It is recommended that the L1000 size be installed low on the door so that it is easier to open and close in facilities used by children and those who use a wheelchair.



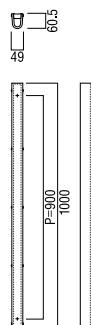
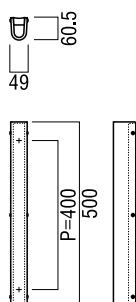

H2800

Base Material

Plywood and Aluminium

Available Finish

Plywood Natural Colour & Aluminium Uni-Frost Anodized Silver Colour (S)
Plywood Walnut & Aluminium Uni-Frost Anodized Black (B)

Available Sizes (mm)

Length 500, Centres 400

Fixing Holes Sizes

Door 8mm

Specification Code

H2800 - 500 - finish

H2800

Base Material

Plywood and Aluminium

Available Finish

Plywood Natural Colour & Aluminium Uni-Frost Anodized Silver Colour (S)
Plywood Walnut & Aluminium Uni-Frost Anodized Black (B)

Available Sizes (mm)

Length 1000, Centres 900

Fixing Holes Sizes

Door 8mm

Specification Code

H2800 - 1000 - finish



MEDIUM ENTRY PULLS *by Elmes of Japan*

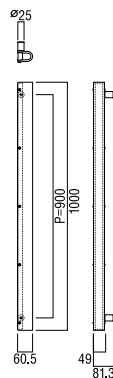
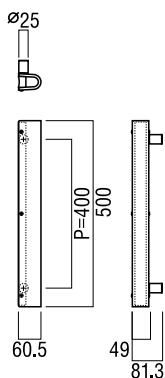

G2800

Base Material
Plywood and Aluminium

Available Finish
Plywood Natural Colour &
Aluminium Uni-Frost & Anodized
Silver Colour (S)
Plywood Walnut Aluminium Uni-
Frost & Anodized Black (B)

Available Sizes (mm)
Length 500, Centres 400

Fixing Holes Sizes
Door 8mm, Glass 12mm

Specification Code
G2800 - 500 - finish

G2800

Base Material
Plywood and Aluminium

Available Finish
Plywood Natural Colour &
Aluminium Uni-Frost & Anodized
Silver Colour (S)
Plywood Walnut Aluminium Uni-
Frost & Anodized Black (B)

Available Sizes (mm)
Length 1000, Centres 900

Fixing Holes Sizes
Door 8mm, Glass 12mm

Specification Code
G2800 - 1000 - finish

Natural designs that enhance a space, gently.

The expression of natural wood lends comfort and serenity to a space. With uses in places such as kindergartens, the design features a slightly larger grip that is easy for children to handle. Finished with a gentle grip so that no edges protrude when grasped. A warm design in which bark gives a pleasant impression that is easy not only for children to use but for the elderly as well.





T2740 - 600 - M



T2740 - 150 - M



T2741 - 200 - M

T2740 & T2741

Base Material
Aluminium & Maple

Available Finish
Uni Frost Anodized Silver Colour
& Maple Clear Coating (M)

Available Sizes (mm)
Length 150, Centres 120
Length 200, Centres 60
Length 600, Centres 425

Fixing Holes Sizes
Door 8mm, Glass 12mm

Specification Code
T2740 - 150 - M

T2741 - 200 - M

T2740 - 600 - M

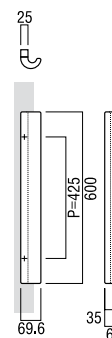
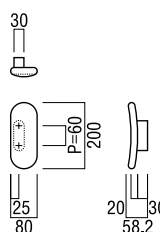
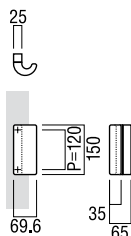

A vertical wooden handle is mounted on a light-colored wall. To the right of the handle is a window with white curtains. The handle is a simple, cylindrical wooden piece. The background shows a window with white curtains and a view of a landscape with hills.

A sliding door handle that doesn't need to be gripped allows freedom of movement.

Affordance is the key word to achieve form that is neither grasped nor gripped, a triangular shape that allows the door to be opened and closed with just a light touch. By moving the installation position to the edge of the door it is possible to lessen the amount of the door left exposed while maintaining the natural ease of use. Achieve an opening width with enough space for movement even for those who use a wheelchair in places such as hospitals and welfare facilities. The combination of aluminium base goes well with the dark brown beech grip.

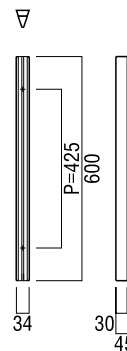
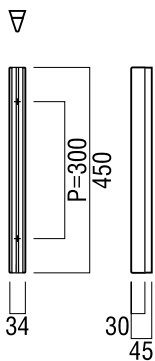

H2860

Base Material
Aluminium & Beech

Available Finish
Anodized Silver Colour &
Japanese Beech, Clear Paint (M)

Anodized Silver Colour &
Japanese Beech, Smoked Brown
Paint (S)

Available Sizes (mm)
Length 450, Centres 300

Fixing Holes Sizes
Door 8mm

Specification Code
H2860 - 450 - M
H2860 - 450 - S

H2860

Base Material
Aluminium & Beech

Available Finish
Anodized Silver Colour &
Japanese Beech, Clear Paint (M)

Anodized Silver Colour &
Japanese Beech, Smoked Brown
Paint (S)

Available Sizes (mm)
Length 600, Centres 425

Fixing Holes Sizes
Door 8mm

Specification Code
H2860 - 600 - M
H2860 - 600 - S

You have two types of expressions when the warmth of wood is added to a basic expression

A simple modern design utilizing the texture of aluminium, with natural wood on the rear surface adds warmth to the design. The nonchalant existence of both plates allows for use within a wide range of spaces, from offices to commercial buildings





T2871

Base Material
Aluminium

Available Finish
Uni Frost Anodized Silver Colour (S)
Uni Frost Anodized Black (B)

Available Sizes (mm)
Length 600, Centres 500

Fixing Holes Sizes
Door 10mm, Glass 16mm

Specification Code
T2871 - 600 - S
T2871 - 600 - B

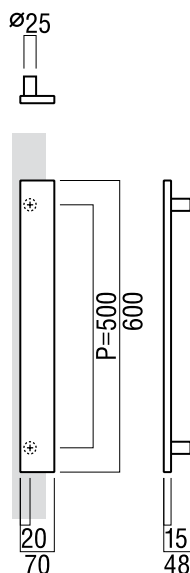

T2870

Base Material
Aluminium & Maple & Stainless Steel

Available Finish
Uni Frost Anodized Silver Colour & Maple Clear Coating with Stainless Steel Hairline (M)
Uni Frost Anodized Black & Walnut Clear Coating with Stainless Steel Hairline (W)

Available Sizes (mm)
Length 600, Centres 500

Fixing Holes Sizes
Door 10mm, Glass 16mm

Specification Code
T2870 - 600 - M
T2870 - 600 - W

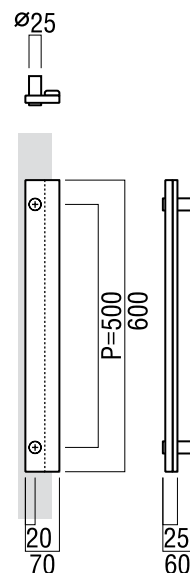



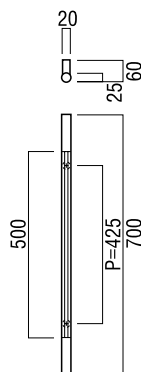
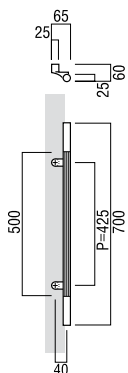
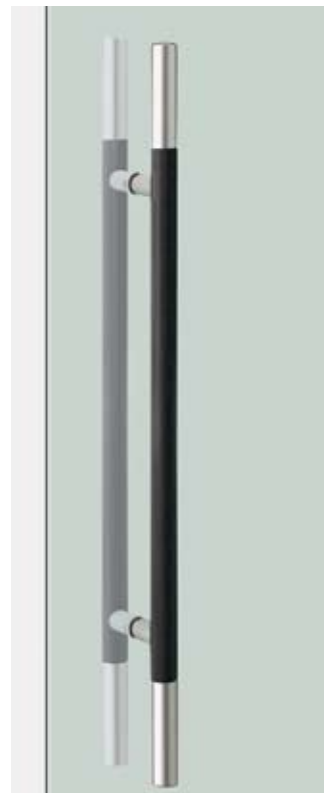
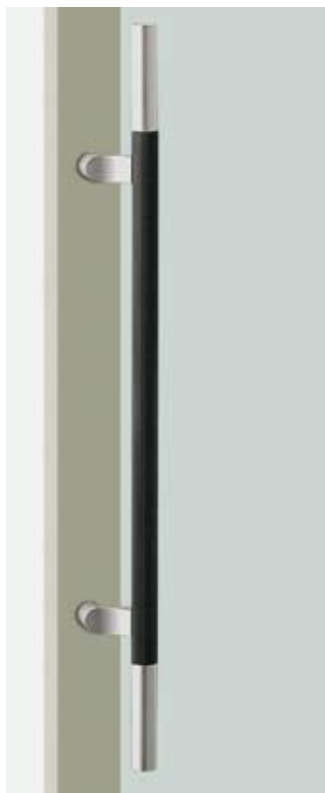
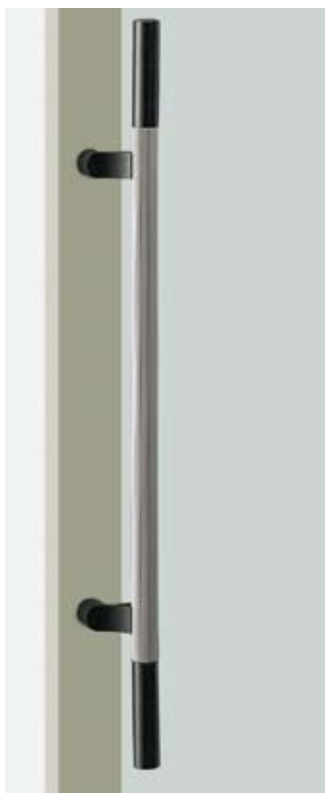

T7110

Base Material
Aluminium

Available Finish

- Uni-Frost Anodized Silver + Black (SB)
- Uni-Frost Anodized Black + Silver (BS)
- Uni-Frost Anodized Black + Blast Anodized Gold (BG)

Available Sizes (mm)

Length 700, Centres 425

Fixing Holes Sizes

Door 10mm, Glass 16mm

Specification Code

T7110 - 700 - finish

G7110

Base Material
Aluminium

Available Finish

- Uni-Frost Anodized Silver + Black (SB)
- Uni-Frost Anodized Black + Silver (BS)
- Uni-Frost Anodized Black + Blast Anodized Gold (BG)

Available Sizes (mm)

Length 700, Centres 425

Fixing Holes Sizes

Door 8mm, Glass 12mm

Specification Code

G7110 - 700 - finish

MEDIUM ENTRY PULLS *by Elmes of Japan*

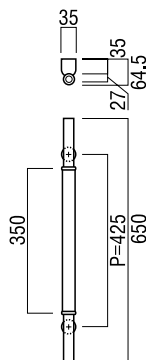
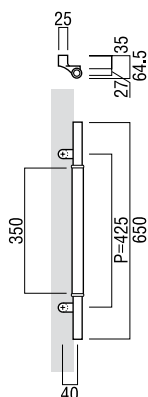
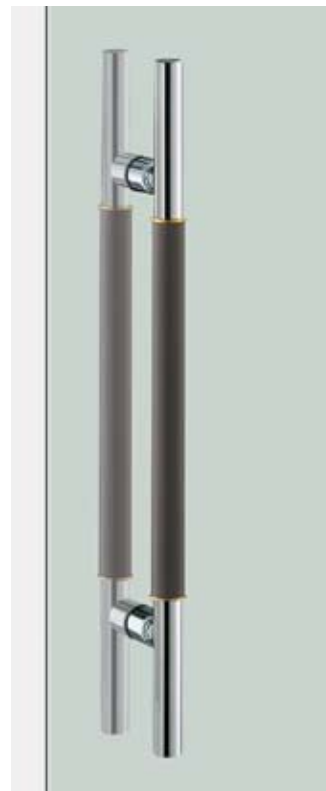
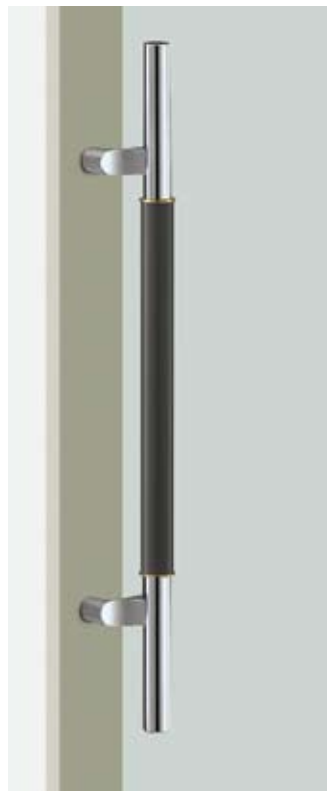

T736

Base Material
Stainless Steel

Available Finish

- Uni-Colour (Blast Baked Finish) Black & Polished Stainless with Brass & Bright Chrome (BP)
- Uni-Colour (Blast Baked Finish) Grey & Polished Stainless with Brass & Bright Chrome (GP)
- Uni-Colour (Blast Baked Finish) Blue & Polished Stainless with Brass & Bright Chrome (BLP)
- Uni-Colour (Blast Baked Finish) Deep Red & Polished Stainless with Brass & Bright Chrome (RP)

Available Sizes (mm)

Length 650, Centres 425

Fixing Holes Sizes

Door 10mm, Glass 16mm

Specification Code

T736 - 650 - finish

G736

Base Material
Stainless Steel, Brass,
Uniwood with Stainless Steel

Available Finish

- Uni-Colour (Blast Baked Finish) Black & Polished Stainless with Brass & Bright Chrome (BP)
- Uni-Colour (Blast Baked Finish) Grey & Polished Stainless with Brass & Bright Chrome (GP)
- Uni-Colour (Blast Baked Finish) Blue & Polished Stainless with Brass & Bright Chrome (BLP)
- Uni-Colour (Blast Baked Finish) Deep Red & Polished Stainless with Brass & Bright Chrome (RP)

Available Sizes (mm)

Length 650, Centres 425

Fixing Holes Sizes

Door 10mm, Glass 16mm

Specification Code

G736 - 650 - finish

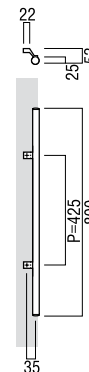
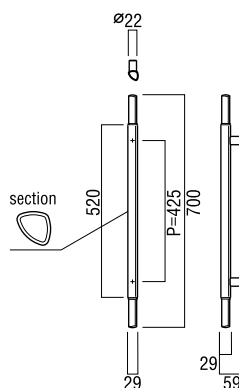
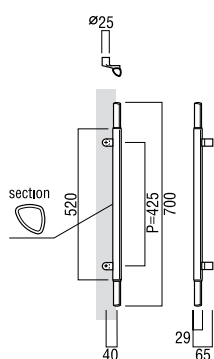
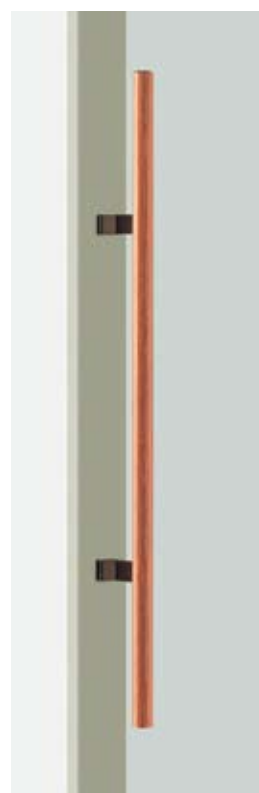

T2629

Base Material
Brass & Uniwood (Antibacterial Compressed Wood)

Available Finish
Uni-Wood Brown & Bright Chrome (B)
Uni-Wood Scotch Colour & Bright Chrome (S)

Available Sizes (mm)
Length 700, Centres 425

Fixing Holes Sizes
Door 10mm, Glass 16mm

Specification Code
T2629 - 700 - finish

G2629

Base Material
Brass & Uniwood (Antibacterial Compressed Wood)

Available Finish
Uni-Wood Brown & Bright Chrome (B)
Uni-Wood Scotch Colour & Bright Chrome (S)

Available Sizes (mm)
Length 700, Centres 425

Fixing Holes Sizes
Door 10mm, Glass 16mm

Specification Code
G2629 - 700 - finish

T720

Base Material
Stainless Steel, Brass, Uniwood & Aluminium, Aluminium

Available Finish
Hairline Stainless Steel (H)
Polished Stainless Steel (P)
Polished Brass (BR)
Brown Uniwood with Anodized Umber Legs (BU)
Aluminium Anodized Black (AB)
Aluminium Anodized Umber (AU)

Available Sizes (mm)
Length 800, Centres 425

Fixing Holes Sizes
Door 8mm, Glass 12mm

Specification Code
T720 - 800 - finish

MEDIUM ENTRY PULLS *by Elmes of Japan*

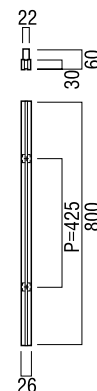
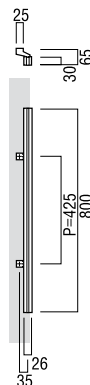
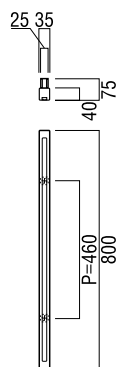
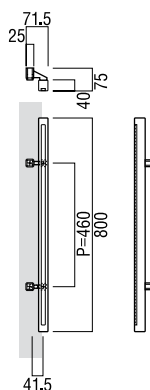
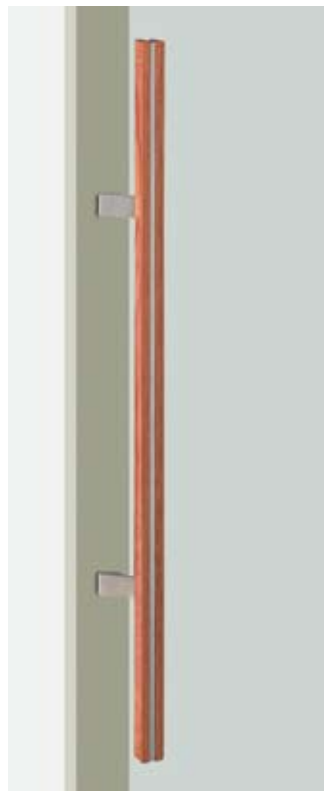
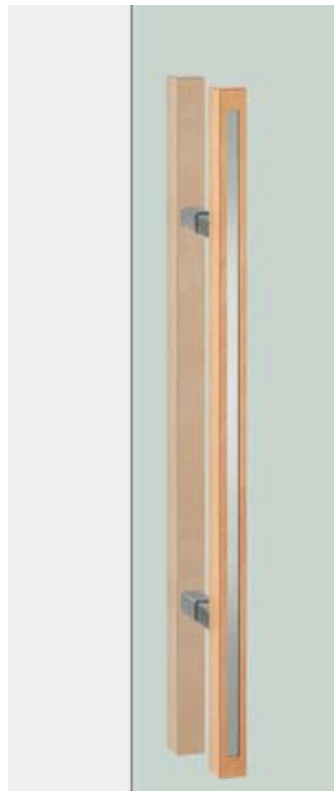
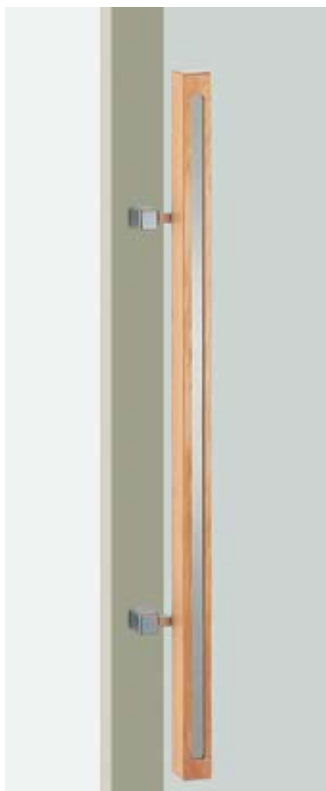

T2313

Base Material
Uniwood (Antibacterial Compressed Wood) & Stainless Steel

Available Finish
Uni-Wood White with Stainless Steel Insert & Polished Stainless Legs (W)

Available Sizes (mm)
Length 800, Centres 460

Fixing Holes Sizes
Door 10mm, Glass 16mm

Specification Code
T2313 - 800 - W

G2313

Base Material
Uniwood (Antibacterial Compressed Wood) & Stainless Steel

Available Finish
Uni-Wood White with Stainless Steel Insert & Polished Stainless Legs (W)

Available Sizes (mm)
Length 800, Centres 460

Fixing Holes Sizes
Door 10mm, Glass 16mm

Specification Code
G2313 - 800 - W

T530

Base Material
Uniwood (Antibacterial Compressed Wood) & Stainless Steel

Available Finish
Uni-Wood Brown with Stainless Steel Insert & Hairline Stainless Legs (B)

Available Sizes (mm)
Length 800, Centres 425

Fixing Holes Sizes
Door 8mm, Glass 12mm

Specification Code
T530 - 800 - B

G530

Base Material
Uniwood (Antibacterial Compressed Wood) & Stainless Steel

Available Finish
Uni-Wood Brown with Stainless Steel Insert & Hairline Stainless Legs (B)

Available Sizes (mm)
Length 800, Centres 425

Fixing Holes Sizes
Door 10mm, Glass 16mm

Specification Code
G530 - 800 - B

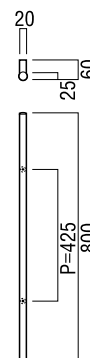
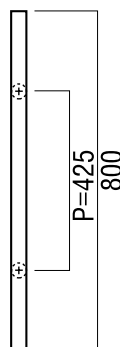
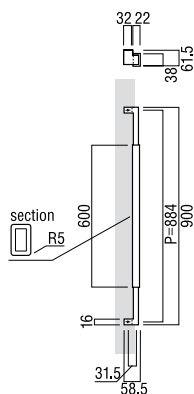
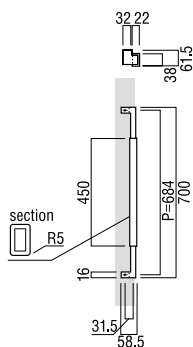
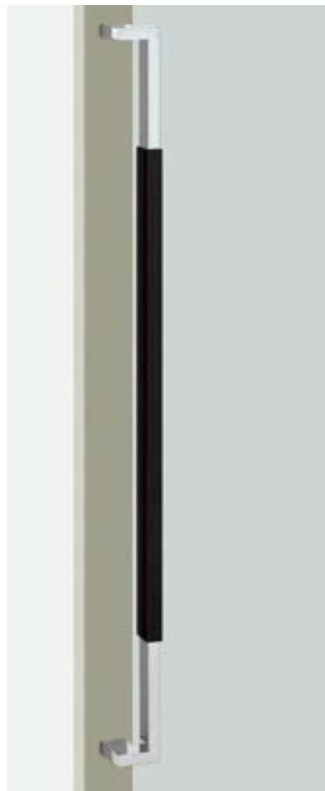
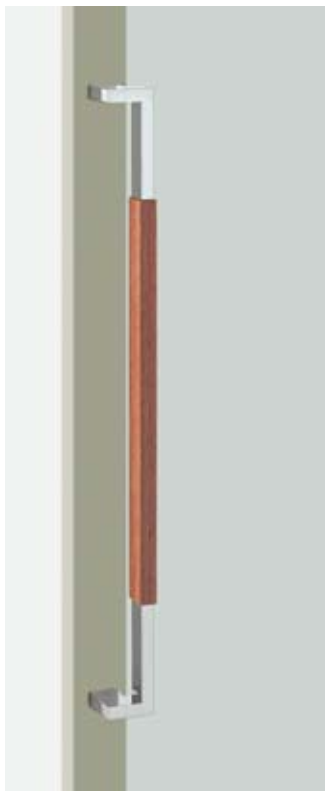

T626

Base Material

Uniwood (Antibacterial Compressed Wood) & Stainless Steel

Available Finish

Uni-Wood Brown & Polished Stainless (B)
Uni-Wood Black & Polished Stainless (BL)

Available Sizes (mm)

Length 700, Centres 648
Length 900, Centres 884

Fixing Holes Sizes

Door 8mm, Glass 12mm

Specification Code

T626 - 700 - finish
T626 - 900 - finish

G52

Base Material

Uniwood (Antibacterial Compressed Wood) & Stainless Steel

Available Finish

Uni-Wood Brown & Hairline Stainless (B)

Available Sizes (mm)

Length 600, Centres 425
Length 800, Centres 425
Length 1200, Centres 800

Fixing Holes Sizes

Door 10mm, Glass 16mm

Specification Code

G52 - 600 - B
G52 - 800 - B
G52 - 1200 - B

G720

Base Material

Stainless Steel, Brass, Aluminium, Uniwood (Antibacterial Compressed Wood)

Available Finish

Hairline Stainless Steel (H)
Polished Stainless (PS)
Polished Brass (BR)
Anodized Umber (AU)
Anodized Black (AB)
Uni-Wood Brown & Polished Stainless legs (UB)

Available Sizes (mm)

Length 800, Centres 425

Fixing Holes Sizes

Door 8mm, Glass 12mm

Specification Code

G720 - 800 - finish

Uni-Wood is an original material that adds anti-bacterial qualities to durability.

Uni-Wood is an original material Elmes has developed for indoors. Laminating, heating, compressing and stiffening natural wood impregnated with resin improved durability and makes it anti-bacterial. Available in an assortment of colours; including natural -unvarnished, chic brown and stylish grey.



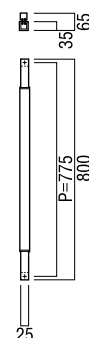
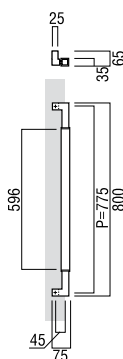
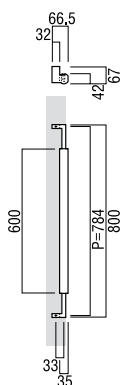
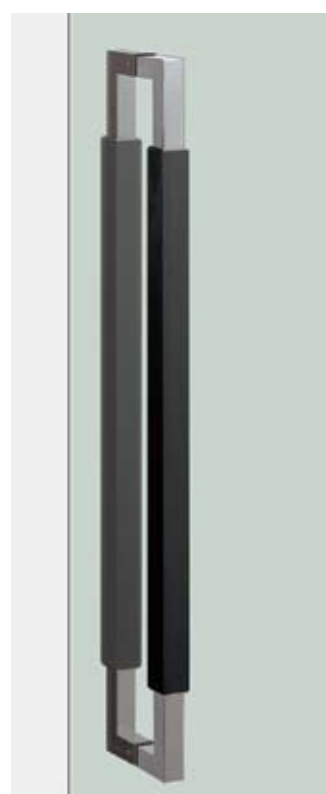
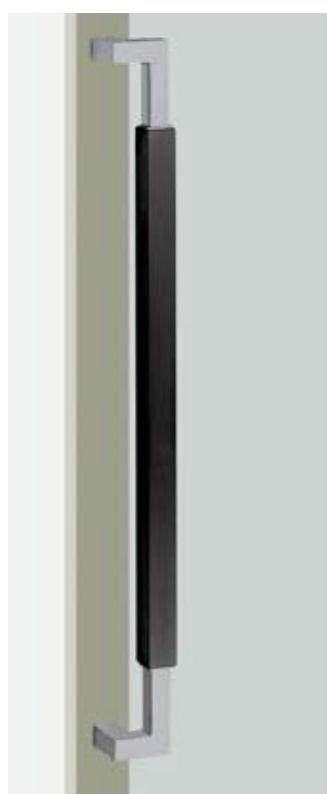

T3363

Base Material
Uniwood (Antibacterial Compressed Wood) & Stainless Steel

Available Finish
Uni-Wood Grey & Polished Stainless Steel Legs (G)
Uni-Wood Scotch & Polished Stainless Steel Legs (S)

Available Sizes (mm)
Length 800, Centres 784

Fixing Holes Sizes
Door 10mm, Glass 12mm

Specification Code
T3363 - 800 - finish

T5400

Base Material
Uniwood (Antibacterial Compressed Wood) & Stainless Steel

Available Finish
Uni-Wood Black & Polished Stainless Legs (B)

Available Sizes (mm)
Length 800, Centres 775

Fixing Holes Sizes
Door 10mm, Glass 16mm

Specification Code
T5400 - 800 - B

G5400

Base Material
Uniwood (Antibacterial Compressed Wood) & Stainless Steel

Available Finish
Uni-Wood Black & Polished Stainless Legs (B)

Available Sizes (mm)
Length 800, Centres 775

Fixing Holes Sizes
Door 10mm, Glass 16mm

Specification Code
G5400 - 800 - B

MEDIUM ENTRY PULLS *by Elmes of Japan*

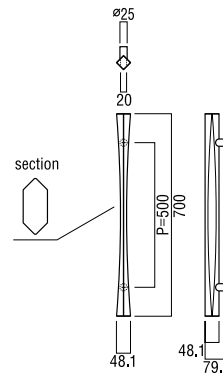
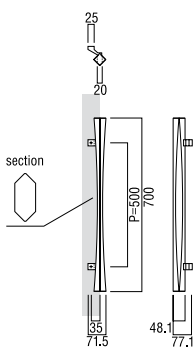
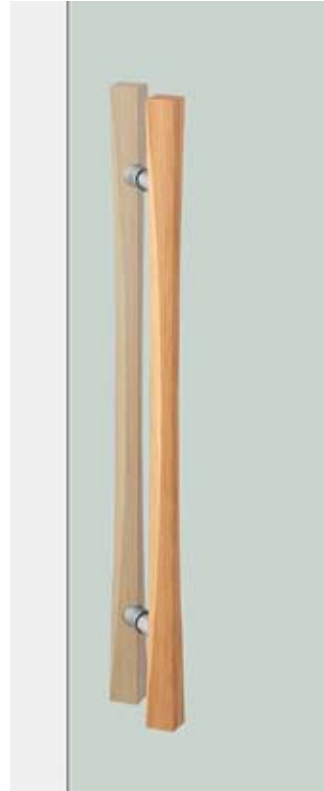

T2759

Base Material
Uniwood (Antibacterial
Compressed Wood) & Stainless Steel

Available Finish
Uni-Wood White & Hairline Stainless (W)
Uni-Wood Scotch & Hairline Stainless (S)

Available Sizes (mm)
Length 700, Centres 500

Fixing Holes Sizes
Door 8mm, Glass 12mm

Specification Code
T2759 - 700 - finish

G2759

Base Material
Uniwood (Antibacterial
Compressed Wood) & Stainless Steel

Available Finish
Uni-Wood White & Hairline Stainless (W)
Uni-Wood Scotch & Hairline Stainless (S)

Available Sizes (mm)
Length 700, Centres 500

Fixing Holes Sizes
Door 10mm, Glass 16mm

Specification Code
G2759 - 700 - finish

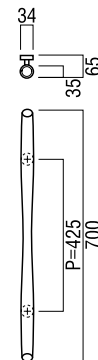
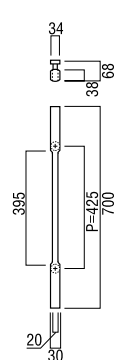
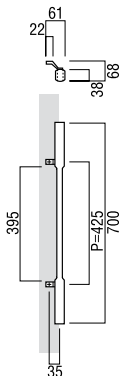
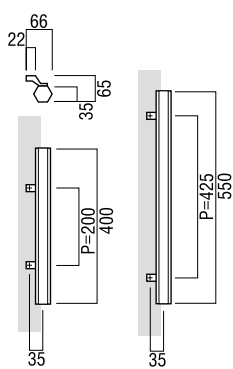
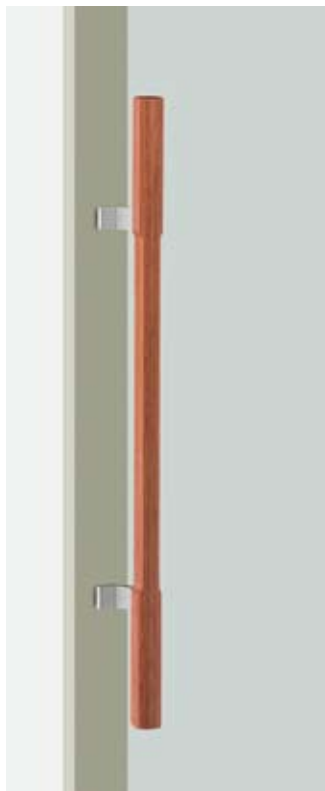
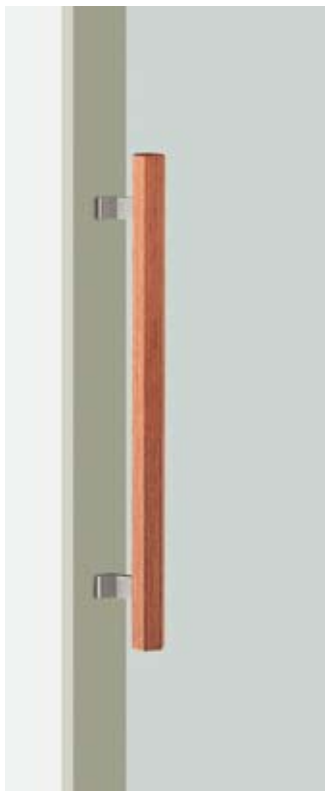

T220

Base Material
Uniwood (Antibacterial Compressed Wood) & Aluminium

Available Finish
Uni-Wood Brown & Anodized Aluminium Silver (B)

Available Sizes (mm)
Length 550, Centres 425
Length 400, Centres 200

Fixing Holes Sizes
Door 8mm, Glass 12mm

Specification Code
T220 - 550 - B
T220 - 400 - B

T590

Base Material
Uniwood (Antibacterial Compressed Wood) & Aluminium

Available Finish
Uni-Wood Brown & Anodized Aluminium Silver (B)

Available Sizes (mm)
Length 700, Centres 425

Fixing Holes Sizes
Door 8mm, Glass 12mm

Specification Code
T590 - 700 - B

G590

Base Material
Uniwood (Antibacterial Compressed Wood) & Stainless Steel

Available Finish
Uni-Wood Brown & Hairline Stainless Steel (B)

Available Sizes (mm)
Length 700, Centres 425

Fixing Holes Sizes
Door 10mm, Glass 16mm

Specification Code
G590 - 700 - B

G78

Base Material
Uniwood (Antibacterial Compressed Wood) & Stainless Steel

Available Finish
Uni-Wood Brown & Hairline Stainless Steel (B)

Available Sizes (mm)
Length 700, Centres 425

Fixing Holes Sizes
Door 10mm, Glass 16mm

Specification Code
G78 - 700 - B

MEDIUM ENTRY PULLS *by Elmes of Japan*

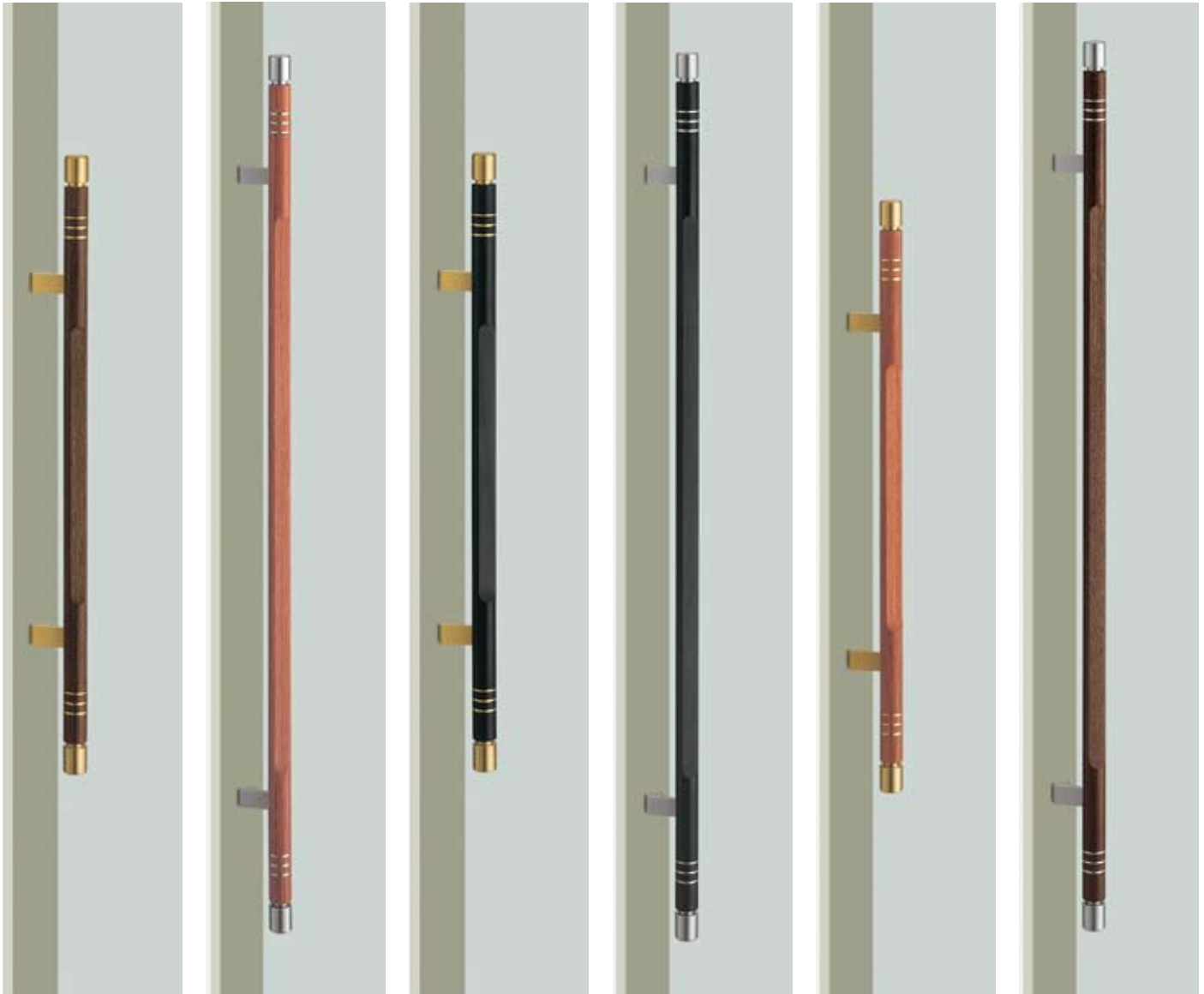

T2412

Base Material
Uniwood (Antibacterial
Compressed Wood) & Stainless
Steel

Available Finish
Uni-Wood Brown & Hairline
Stainless (B)
Uni-Wood Scotch & Hairline
Stainless (S)
Uni-Wood Black & Hairline
Stainless (BL)

Available Sizes (mm)
Length 1200, Centres 860
Length 800, Centres 460

Fixing Holes Sizes
Door 8mm, Glass 12mm

Specification Code
T2412 - 1200 - finish
T2412 - 800 - finish

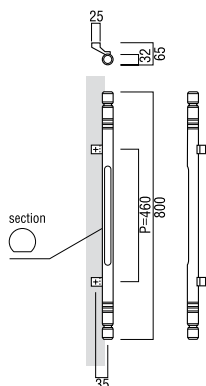

T2412

Base Material
Uniwood (Antibacterial
Compressed Wood) & Brass

Available Finish
Uni-Wood Brown & Hairline Brass (BB)
Uni-Wood Scotch & Hairline Brass (BS)
Uni-Wood Black & Hairline Brass (BBL)

Available Sizes (mm)
Length 1200, Centres 860
Length 800, Centres 460

Fixing Holes Sizes
Door 8mm, Glass 12mm

Specification Code
T2412 - 1200 - finish
T2412 - 800 - finish

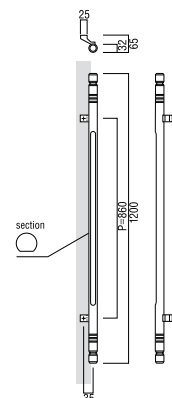

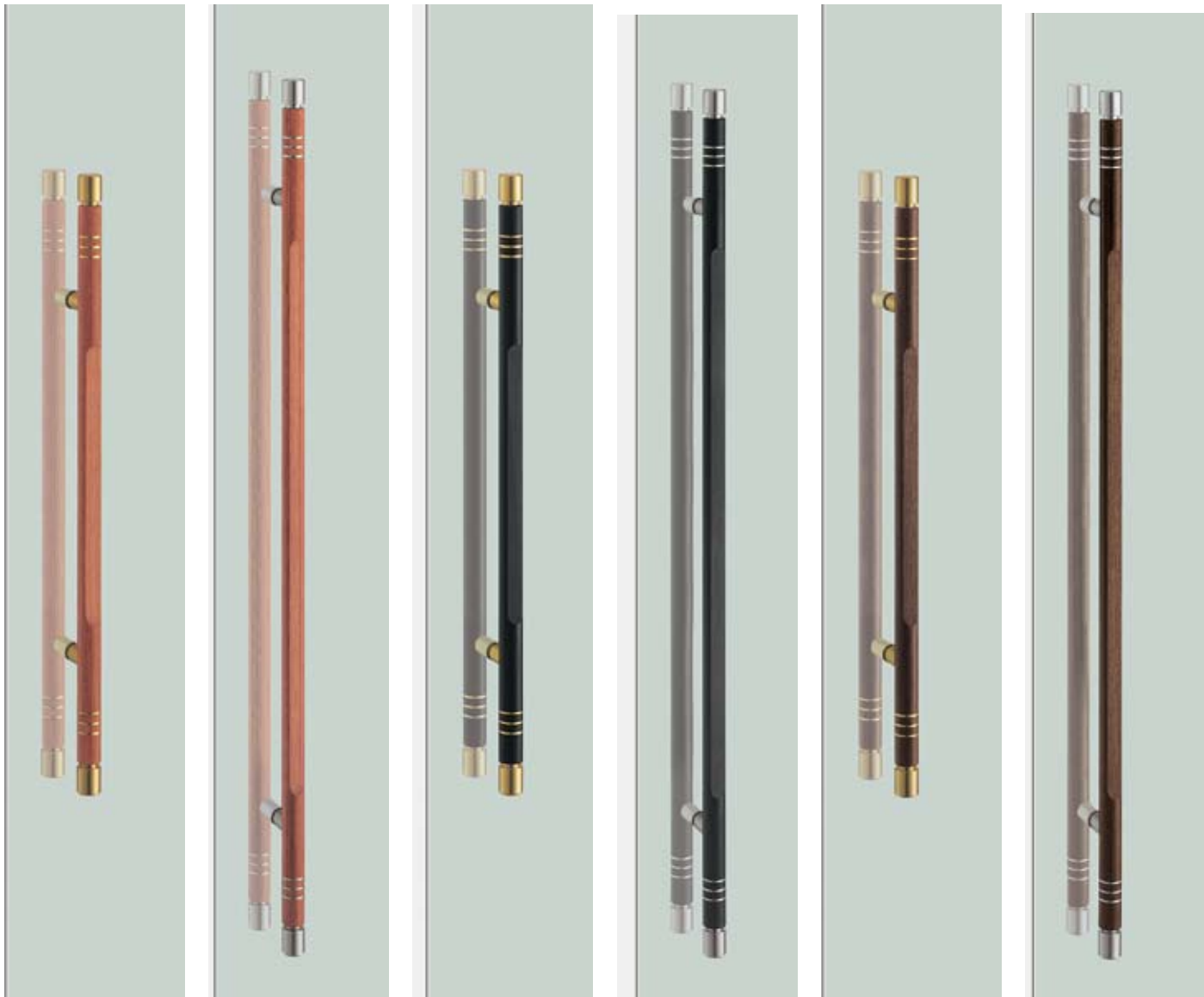

G2412

Base Material
Uniwood (Antibacterial
Compressed Wood) & Stainless Steel

Available Finish
Uni-Wood Brown & Hairline Stainless (B)
Uni-Wood Scotch & Hairline Stainless (S)
Uni-Wood Black & Hairline Stainless (BL)

Available Sizes (mm)
Length 1200, Centres 860
Length 800, Centres 460

Fixing Holes Sizes
Door 10mm, Glass 16mm

Specification Code
G2412 - 1200 - finish
G2412 - 800 - finish

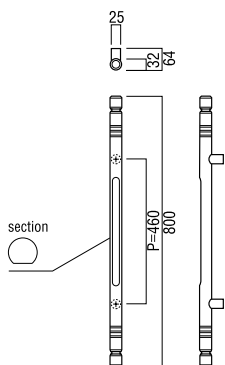

G2412

Base Material
Uniwood (Antibacterial
Compressed Wood) & Brass

Available Finish
Uni-Wood Brown & Hairline Brass (BB)
Uni-Wood Scotch & Hairline Brass (BS)
Uni-Wood Black & Hairline Brass (BBL)

Available Sizes (mm)
Length 1200, Centres 860
Length 800, Centres 460

Fixing Holes Sizes
Door 10mm, Glass 16mm

Specification Code
G2412 - 1200 - finish
G2412 - 800 - finish

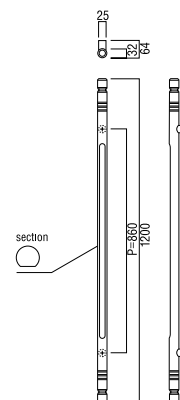

MEDIUM ENTRY PULLS *by Elmes of Japan*

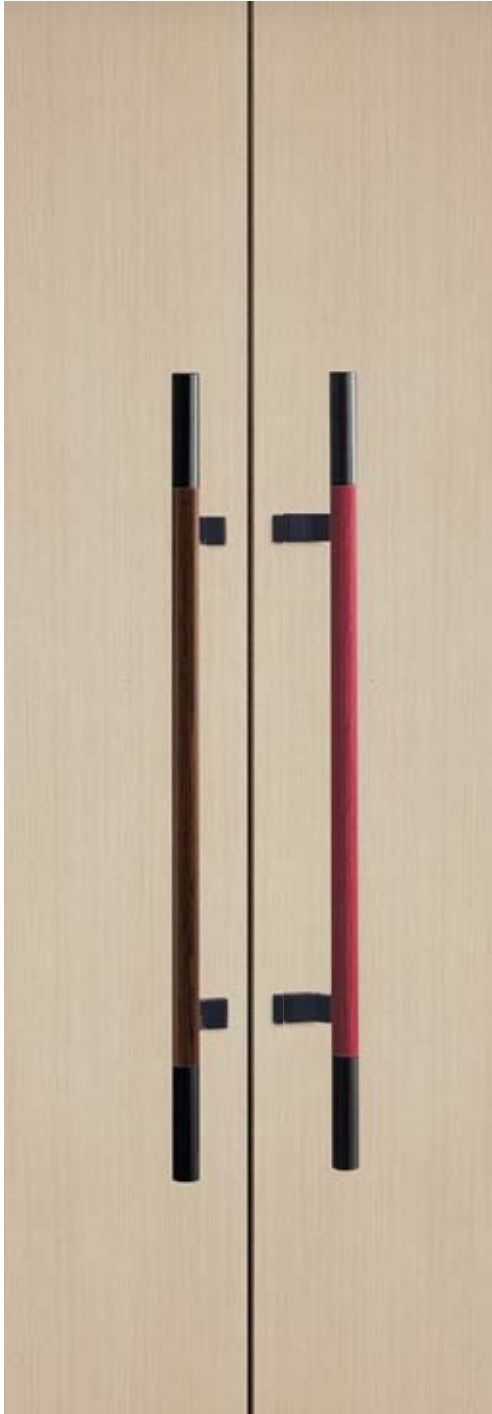

T3321

Base Material

Uniwood (Antibacterial Compressed Wood) & Aluminum

Available Finish

- Uni-Wood White & Coating Black & Anodized Black legs (W)
- Uni-Wood Grey & Coating Black & Anodized Black legs (G)
- Uni-Wood Brown & Coating Black & Anodized Black legs (B)
- Uni-Wood Red & Coating Black & Anodized Black legs (R)
- Uni-Wood Scotch & Coating Black & Anodized Black legs (S)

Available Sizes (mm)

Length 700, Centres 425mm

Fixing Holes Sizes

Door 8mm, Glass 12mm

Specification Code

T3321 - 700 - finish

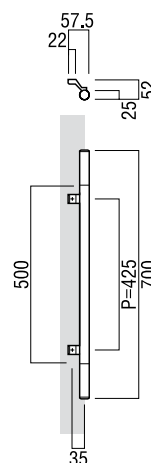



G3321

Base Material

Uniwood (Antibacterial Compressed Wood) & Aluminum

Available Finish

- Uni-Wood White & Coating Black & Anodized Black legs (W)
- Uni-Wood Grey & Coating Black & Anodized Black legs (G)
- Uni-Wood Brown & Coating Black & Anodized Black legs (B)
- Uni-Wood Red & Coating Black & Anodized Black legs (R)
- Uni-Wood Scotch & Coating Black & Anodized Black legs (S)

Available Sizes (mm)

Length 700, Centres 425mm

Fixing Holes Sizes

Door 8mm, Glass 12mm

Specification Code

G3326 - 700 - finish

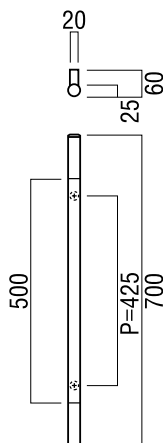

MEDIUM ENTRY PULLS *by Elmes of Japan*

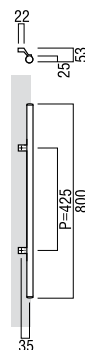
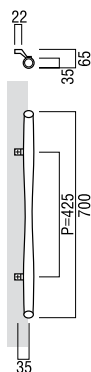
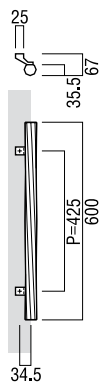
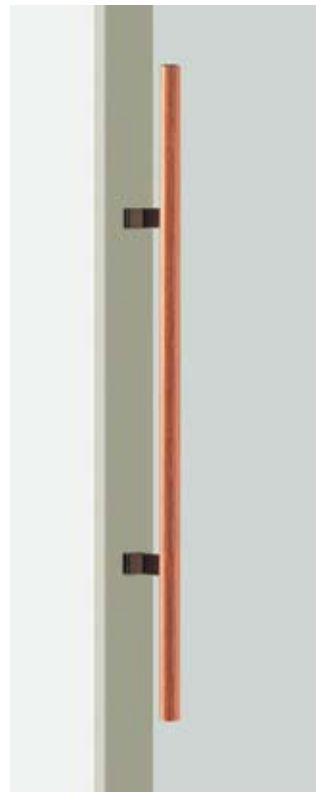

T2208

Base Material
Uniwood (Antibacterial Compressed Wood) with Stainless Steel

Available Finish
Uni-Wood Black & Hairline Stainless (B)

Available Sizes (mm)
Length 600, Centres 425

Fixing Holes Sizes
Door 8mm, Glass 12mm

Specification Code
T2208 - 600 - B

T78

Base Material
Uniwood (Antibacterial Compressed Wood) & Aluminium

Available Finish
Uni-Wood Brown & Anodized Aluminium Silver (B)

Available Sizes (mm)
Length 700, Centres 425

Fixing Holes Sizes
Door 8mm, Glass 12mm

Specification Code
T78 - 700 - B

T720

Base Material
Uniwood (Antibacterial Compressed Wood) and Aluminium

Available Finish
Uni-Wood Brown and Anodized Aluminium Umber (U)

Available Sizes (mm)
Length 800, Centres 425

Fixing Holes Sizes
Door 8mm, Glass 12mm

Specification Code
T720 - 800 - U

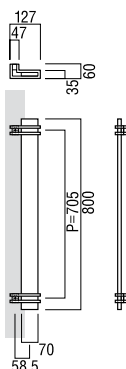
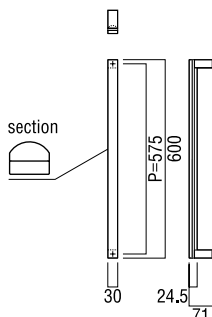
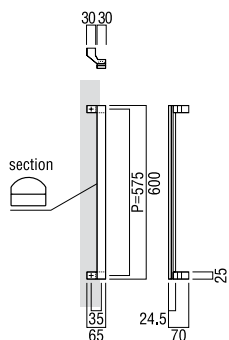
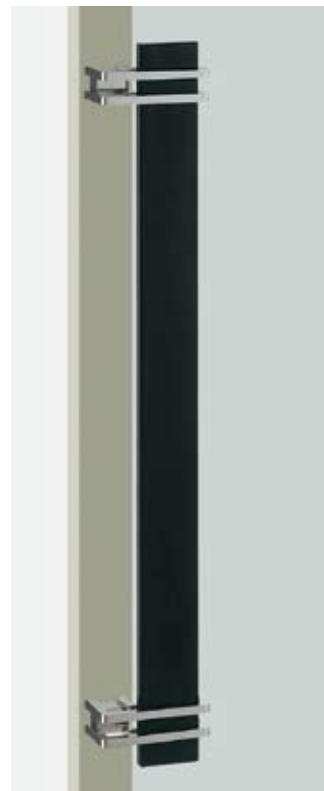
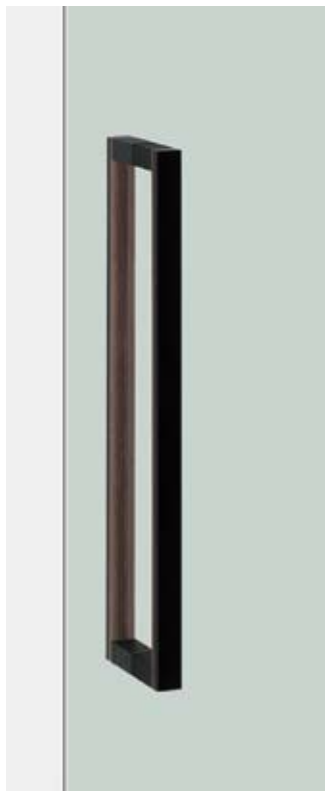
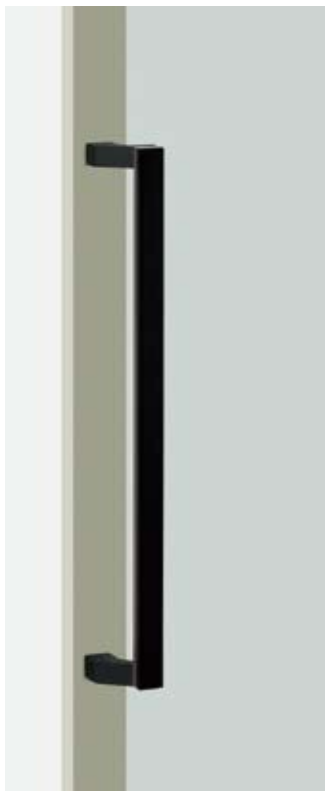

T2733

Base Material
Uniwood (Antibacterial
Compressed Wood) & Aluminium

Available Finish
Uni-Wood Scotch & Aluminium
Blast Black (S)

Available Sizes (mm)
Length 600, Centres 575
Fixing Holes Sizes
Door 10mm, Glass 16mm

Specification Code
T2733 - 600 - S

G2733

Base Material
Uniwood (Antibacterial
Compressed Wood) & Aluminium

Available Finish
Uni-Wood Scotch & Aluminium
Blast Black (S)

Available Sizes (mm)
Length 600, Centres 575
Fixing Holes Sizes
Door 10mm, Glass 16mm

Specification Code
G2733 - 600 - S

T2318

Base Material
Uniwood (Antibacterial
Compressed Wood) & Stainless
Steel

Available Finish
Uni-Wood Black & Polished
Stainless Legs (B)
Uni-Wood Scotch & Polished
Stainless Legs (S)

Available Sizes (mm)
Length 800, Centres 705

Fixing Holes Sizes
Door 10mm, Glass 16mm

Specification Code
T2318 - 800 - finish



Apply the austere refined patina and air of Nambu iron to a Door Handle.

Nambu iron has long been loved as a material for tea kettles and cultivated as a Japanese traditional technique. That simple quality and austere refined patina is utilized in a Door Handle. This is a material that becomes rich in expression and profoundly appealing with use, it is a unique thing; a rarity that adds warmth and depth to a space.

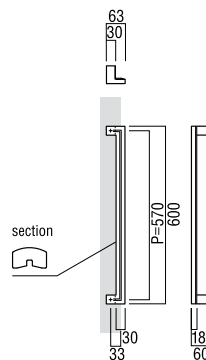
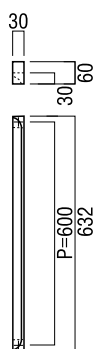
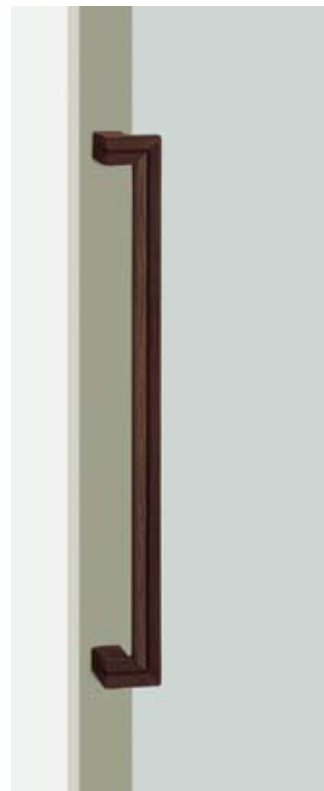
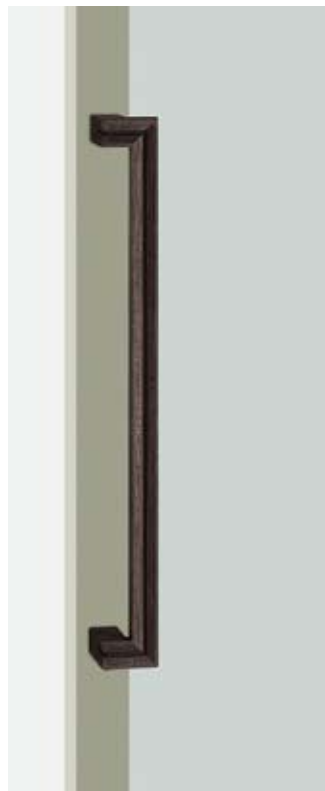
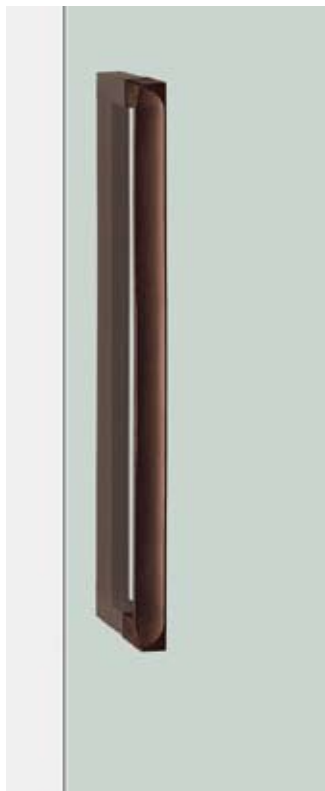

G2236

Base Material
Japanese Cast Iron (Nambu-Tetsu)

Available Finish
Baked Finish Red Rust Colour (R)
Baked Finish Iron Rust Colour (I)

Available Sizes (mm)
Length 632, Centres 600

Fixing Holes Sizes
Door 10mm, Glass 16mm

Specification Code
G2236 - 632- finish

T2618

Base Material
Japanese Cast Iron (Nambu-Tetsu)

Available Finish
Baked Finish Red Rust Colour (R)
Baked Finish Iron Rust Colour (I)

Available Sizes (mm)
Length 600, Centres 570

Fixing Holes Sizes
Door 10mm, Glass 16mm

Specification Code
T2618 - 600 - finish

MEDIUM ENTRY PULLS *by Elmes of Japan*

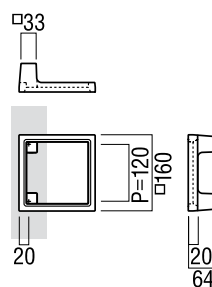
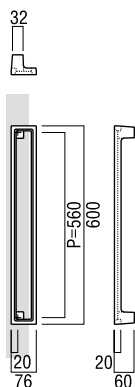
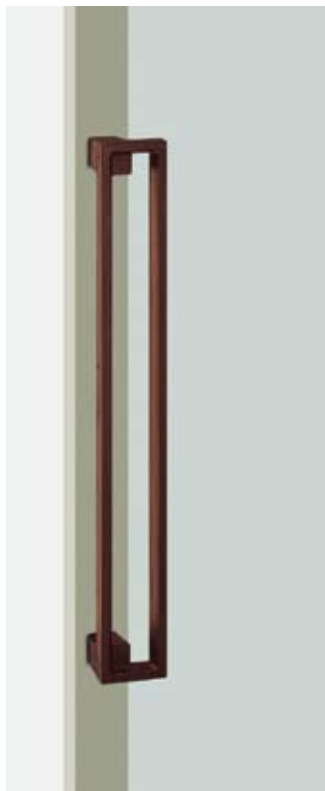
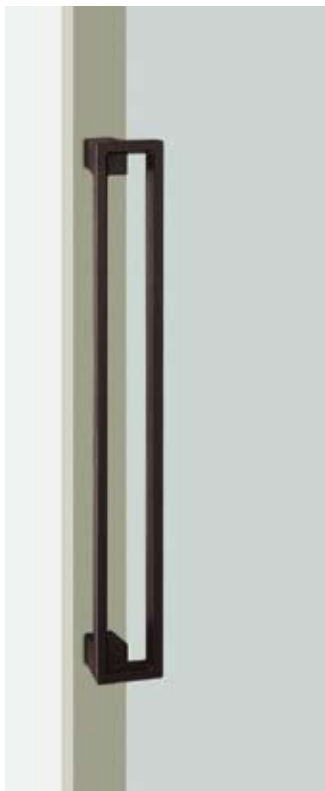

T2719

Base Material
Japanese Cast Iron (Nambu-Tetsu)

Available Finish
Baked Finish Red Rust Colour (R)
Baked Finish Iron Rust Colour (I)

Available Sizes (mm)
Length 600, Centres 560

Fixing Holes Sizes
Door 10mm, Glass 16mm

Specification Code
T2719 - 600 - finish

T2619

Base Material
Japanese Cast Iron (Nambu-Tetsu)

Available Finish
Baked Finish Red Rust Colour (R)
Baked Finish Iron Rust Colour (I)

Available Sizes (mm)
Length 160, Centres 120

Fixing Holes Sizes
Door 10mm, Glass 16mm

Specification Code
T2619 - 160 - finish

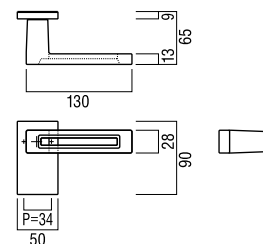
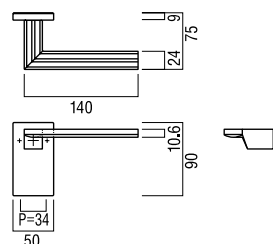
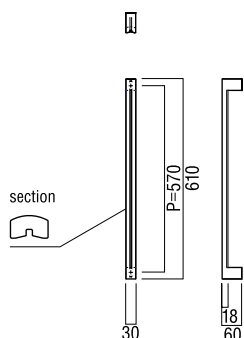
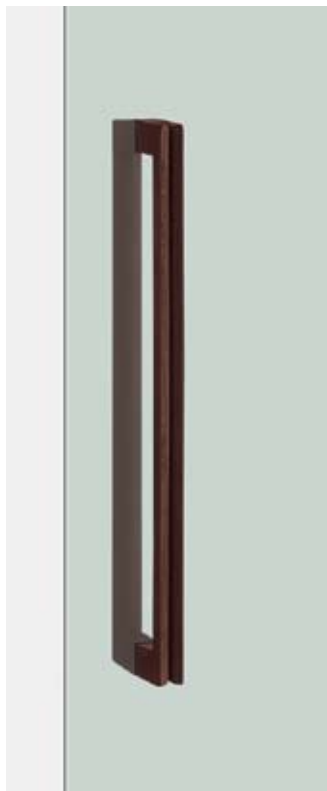

G2618

Base Material
Japanese Cast Iron (Nambu-Tetsu)

Available Finish
Baked Finish Red Rust Colour (R)
Baked Finish Iron Rust Colour (I)

Available Sizes (mm)
Length 610, Centres 570

Fixing Holes Sizes
Door 10mm, Glass 16mm

Specification Code
G2618 - 610- finish

UL728

Base Material
Japanese Cast Iron (Nambu-Tetsu)

Available Finish
Baked Finish Red Rust Colour (R)
Baked Finish Iron Rust Colour (I)

Type
Lock Sets (L)
Passage Sets (P)
Privacy sets (PS)

Suitability
Internal & External Doors

Specification Code
UL728 - R - Type
UL728 - I - Type

UL729

Base Material
Japanese Cast Iron (Nambu-Tetsu)

Available Finish
Baked Finish Red Rust Colour (R)
Baked Finish Iron Rust Colour (I)

Type
Lock Sets (L)
Passage Sets (P)
Privacy sets (PS)

Suitability
Internal & External Doors

Specification Code
UL729 - R - Type
UL729 - I - Type



Texture of the manner that is wrought iron, utilizes the characteristics of aluminium.

The texture of wrought iron is expressed by casting. Because aluminium is used it is light, doesn't rust and its long lasting stable look can be enjoyed. Superiority in cost performance compared to wrought iron is a merit. The real mallet seam pattern is recreated by the craftsman carving wooden forms one by one manually

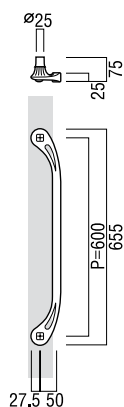
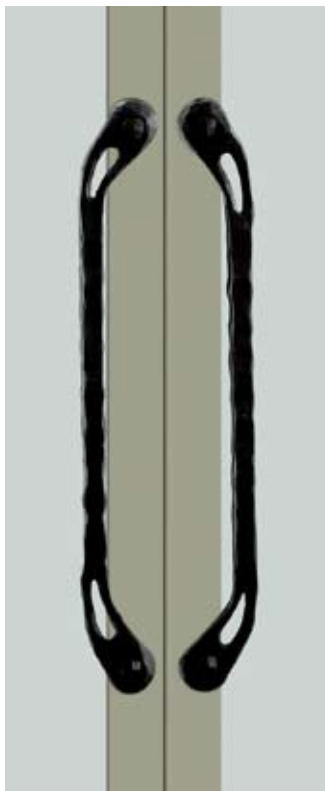

T9962

Base Material
Wrought Iron

Available Finish
Baked Finish Black (B)

Available Sizes (mm)
Length 655, Centres 600

Fixing Holes Sizes
Door 10mm, Glass 16mm

Specification Code
T9962 - 655 - B

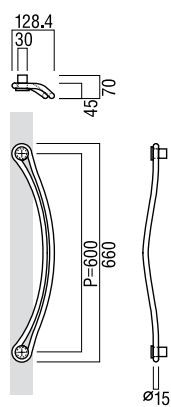
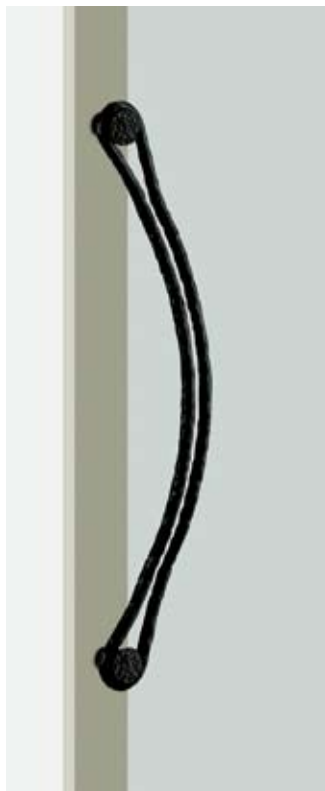

T2302

Base Material
Wrought Iron

Available Finish
Baked Finish Black (B)

Available Sizes (mm)
Length 660, Centres 600

Fixing Holes Sizes
Door 10mm, Glass 16mm

Specification Code
T2302 - 660 - B

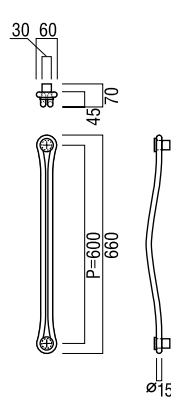

G2302

Base Material
Wrought Iron

Available Finish
Baked Finish Black (B)

Available Sizes (mm)
Length 660, Centres 600

Fixing Holes Sizes
Door 10mm, Glass 16mm

Specification Code
G2302 - 660 - B

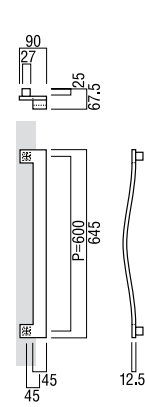

T2303

Base Material
Wrought Iron

Available Finish
Baked Finish Black (B)

Available Sizes (mm)
Length 645, Centres 600
Length 1300, Centres 1255

Fixing Holes Sizes
Door 10mm, Glass 16mm

Specification Code
T2303 - 645 - B
T2303 - 1300 - B

MEDIUM ENTRY PULLS *by Elmes of Japan*

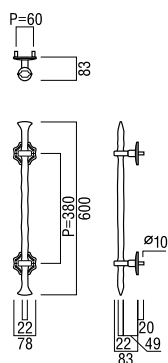
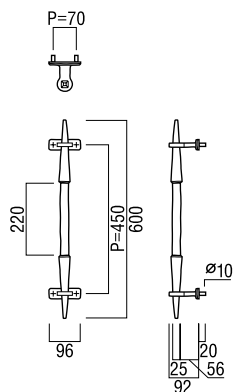

T8904

Base Material
Wrought Iron

Available Finish
Baked Finish Black (B)

Available Sizes (mm)
Length 600, Centres 450

Fixing Holes Sizes
Door Only
Internal Side 8mm
External Side 12mm

Specification Code
T8904 - 600 - B

Note: Not Suitable for Glass Doors

T8901

Base Material
Wrought Iron

Available Finish
Baked Finish Black (B)

Available Sizes (mm)
Length 600, Centres 380

Fixing Holes Sizes
Door Only
Internal Side 8mm
External Side 12mm

Specification Code
T8901 - 600 - B

Note: Not Suitable for Glass Doors

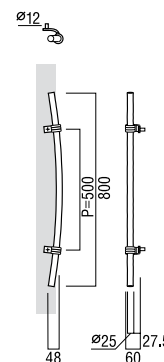
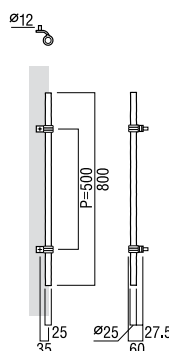
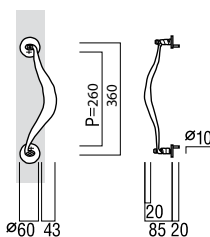
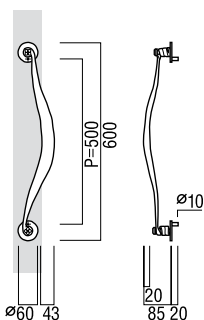
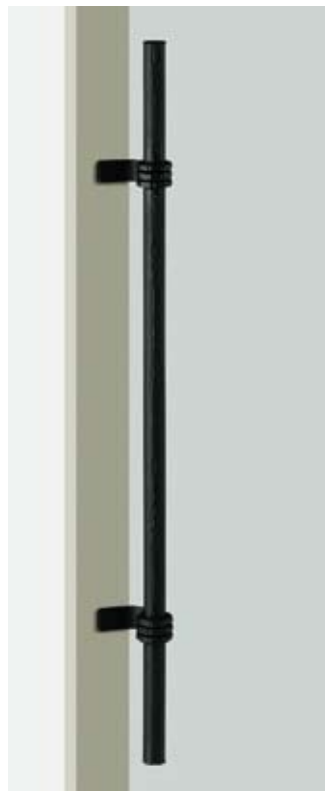

T8908

Base Material
Wrought Iron

Available Finish
Baked Finish Black (B)

Available Sizes (mm)
Length 600, Centres 500

Fixing Holes Sizes
Door Only
Internal Side 8mm
External Side 12mm

Specification Code
T8908 - 600 - B

Note: Not Suitable for Glass Doors

T8909

Base Material
Wrought Iron

Available Finish
Baked Finish Black (B)

Available Sizes (mm)
Length 360, Centres 260

Fixing Holes Sizes
Door Only
Internal Side 8mm
External Side 12mm

Specification Code
T8909 - 360 - B

Note: Not Suitable for Glass Doors

T2523

Base Material
Wrought Iron

Available Finish
Baked Finish Charcoal Grey (G)

Available Sizes (mm)
Length 800, Centres 500

Fixing Holes Sizes
Door Only
Internal Side 10mm
External Side 14mm

Specification Code
T2523 - 800 - G

Note: Not Suitable for Glass Doors

T2524

Base Material
Wrought Iron

Available Finish
Baked Finish Charcoal Grey (G)

Available Sizes (mm)
Length 800, Centres 500

Fixing Holes Sizes
Door Only
Internal Side 10mm
External Side 14mm

Specification Code
T2524 - 800 - G

Note: Not Suitable for Glass Doors

European dignity and quality created by hand wrought iron.

Wrought iron is a craft developed over the ages and part of European culture. A feeling of dignity and unique high quality are created from utilizing the characteristics of iron and repeatedly heating, pounding, bending and twisting by hand. The appeal comes from being handmade so that the expression of each differs subtly.



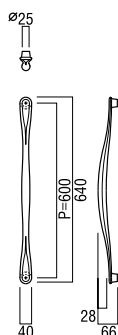

G2607/G2608

Base Material
Uni-Cast Aluminium

Available Finish
Anodized Black (B)

Available Sizes (mm)
Length 640, Centres 600
Length 350, Centres 320

Fixing Holes Sizes
Door 10mm, Glass 16mm
Door 8mm, Glass 12mm (G2608)

Specification Code
G2607 - 640 - B
G2608 - 350 - B

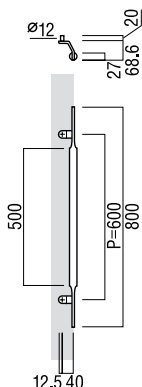
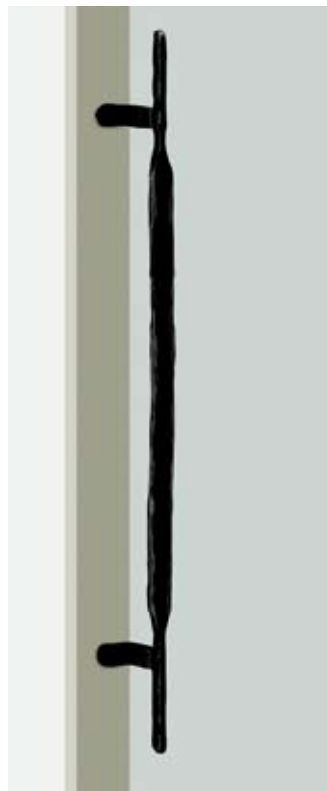

T9961

Base Material
Wrought Iron

Available Finish
Baked Finish Black (B)

Available Sizes (mm)
Length 800, Centres 600

Fixing Holes Sizes
Door Only
Internal Side 10mm
External Side 14mm

Specification Code
T9961 - 800 - B

Note: Not Suitable for Glass
Doors

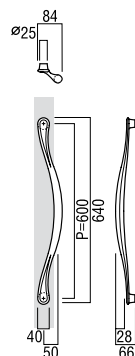

T2607/T2608

Base Material
Uni-Cast Aluminium

Available Finish
Anodized Black (B)

Available Sizes (mm)
Length 640, Centres 600
Length 350, Centres 320

Fixing Holes Sizes
Door 10mm, Glass 16mm
Door 8mm, Glass 12mm (T2608)

Specification Code
T2607 - 640 - B
T2608 - 350 - B

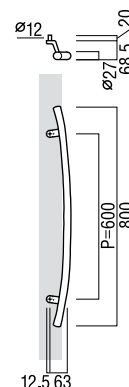
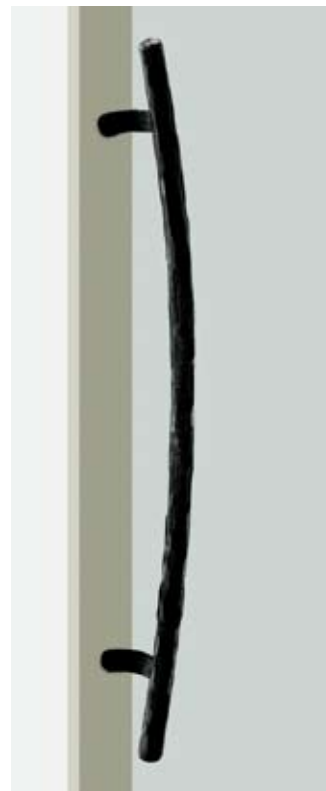

T9960

Base Material
Wrought Iron

Available Finish
Baked Finish Black (B)

Available Sizes (mm)
Length 800, Centres 600

Fixing Holes Sizes
Door Only
Internal Side 10mm
External Side 14mm

Specification Code
T9960 - 800 - B

Note: Not Suitable for Glass
Doors

MEDIUM ENTRY PULLS *by Elmes of Japan*

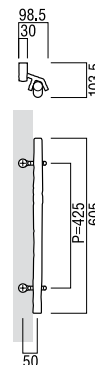
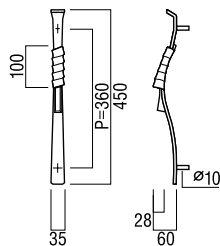
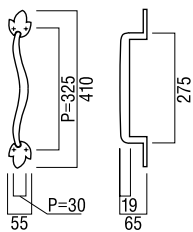

T727

Base Material
Cast Brass

Available Finish
Baked Finish Smoked Silver (S)

Available Sizes (mm)
Length 410, Centres 325

Fixing Holes Sizes
Tapped M4 Hole

Specification Code
T727 - 410 - S
Note: Not Suitable for Glass
Doors. Sold as single handle

T2151

Base Material
Cast Brass

Available Finish
Baked Finish Smoked Silver (S)
Baked Finish Iron Rust (R)

Available Sizes (mm)
Length 450, Centres 360

Fixing Holes Sizes
Internal Side 8mm
External Side 12mm

Specification Code
T2151 - 450 - finish
Note: Not Suitable for Glass
Doors

T2212

Base Material
Cast Brass

Available Finish
Baked Finish Smoked Silver (S)

Available Sizes (mm)
Length 605, Centres 425

Fixing Holes Sizes
Door 10mm, Glass 16mm

Specification Code
T2212 - 605 - S

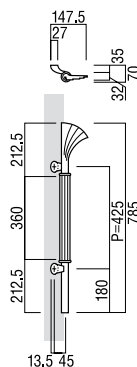
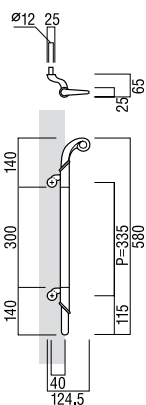

T995

Base Material
Stainless Steel

Available Finish
Polished Stainless Steel (PS)
Hairline & Polished Stainless Steel (HP)

Australian Handing
Australian Left Hand (L)
Australian Right Hand (R)

Available Sizes (mm)
Length 580, Centres 335

Fixing Holes Sizes
Door Only
Internal Side 10mm
External Side 14mm

Specification Code
T995 - 580 - finish - L
T995 - 580 - finish - R

Note: Not Suitable for Glass Doors

T1024

Base Material
Stainless Steel and Brass

Available Finish
Stainless Steel and Polished Brass (SPB)

Australian Handing
Australian Left Hand (L)
Australian Right Hand (R)

Available Sizes (mm)
Length 785, Centres 425

Fixing Holes Sizes
Door 10mm, Glass 16mm

Specification Code
T1024 - 785 - SPB - L
T1024 - 785 - SPB - R

MEDIUM ENTRY PULLS *by Elmes of Japan*

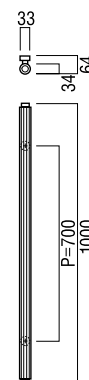
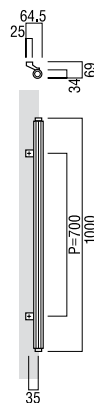
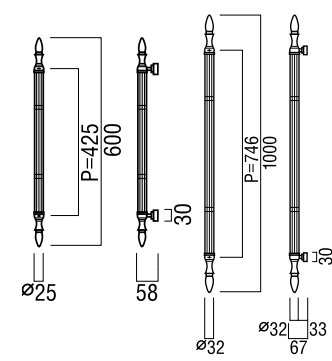
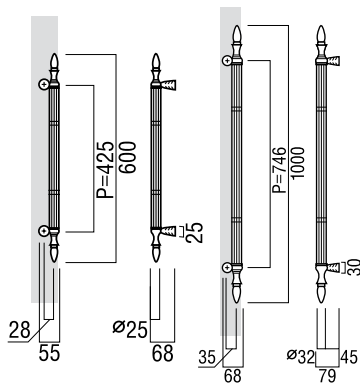
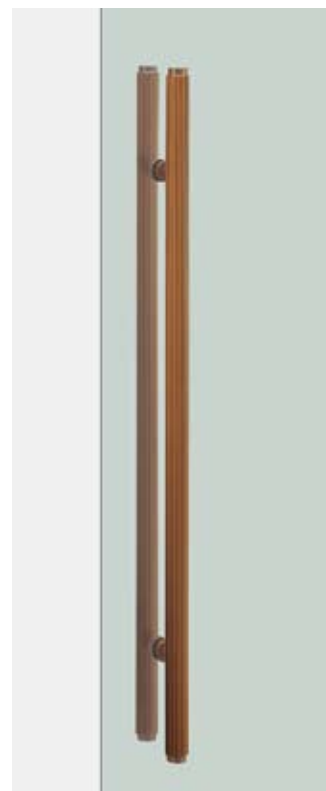
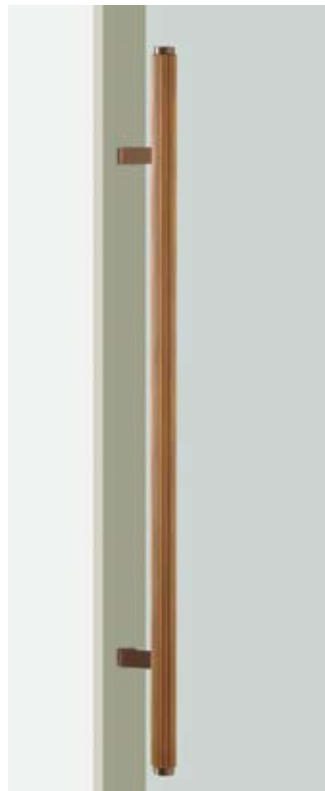

T811

Base Material
Brass

Available Finish
Polished Brass (PB)

Available Sizes (mm)
Length 1000, Centres 746
Length 600, Centres 425

Fixing Holes Sizes
Door 10mm, Glass 16mm

Specification Code
T811 - 1000 - PB
T811 - 600 - PB

G811

Base Material
Brass

Available Finish
Polished Brass (PB)

Available Sizes (mm)
Length 1000, Centres 746
Length 600, Centres 425

Fixing Holes Sizes
Door 10mm, Glass 16mm

Specification Code
G811 - 1000 - PB
G811 - 600 - PB

T860

Base Material
Bronze & Brass

Available Finish
Satin Bronze, Oxidized Brown & Brass, Oxidized Brown (B)

Available Sizes (mm)
Length 1000, Centres 700

Fixing Holes Sizes
Door 10mm, Glass 16mm

Specification Code
T860 - 1000 - B

G860

Base Material
Bronze & Brass

Available Finish
Satin Bronze, Oxidized Brown & Brass, Oxidized Brown (B)

Available Sizes (mm)
Length 1000, Centres 700

Fixing Holes Sizes
Door 10mm, Glass 16mm

Specification Code
G860 - 1000 - B

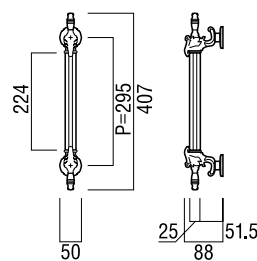
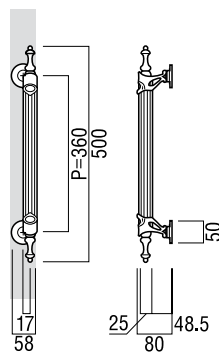
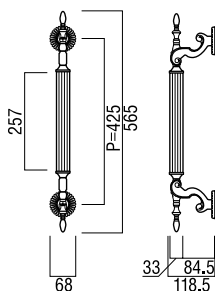
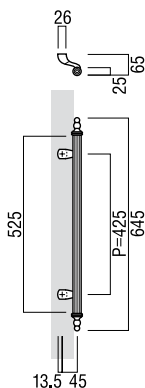
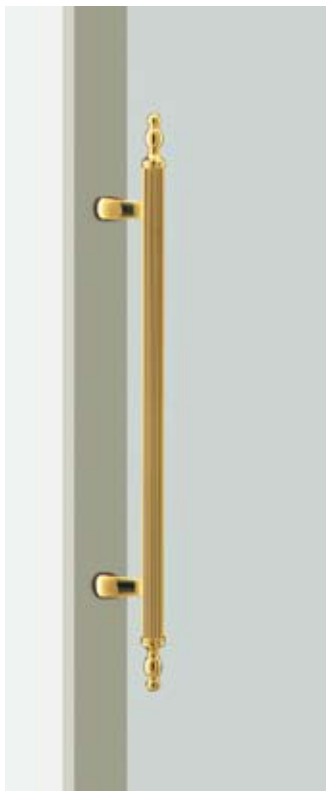

T9972

Base Material
Brass

Available Finish
Polished Brass (PB)

Available Sizes (mm)
Length 645, Centres 425

Fixing Holes Sizes
Door 10mm, Glass 16mm

Specification Code
T9972 - 645 - PB

T812

Base Material
Brass

Available Finish
Oxidized Golden Bronze (B)

Available Sizes (mm)
Length 565, Centres 425

Fixing Holes Sizes
Door 10mm, Glass 16mm

Specification Code
T812 - 565 - B

T924

Base Material
Brass

Available Finish
Polished Brass (PB)

Available Sizes (mm)
Length 500, Centres 360

Fixing Holes Sizes
Door 8mm, Glass 12mm

Specification Code
T924 - 500 - PB

T2043

Base Material
Brass

Available Finish
White Bronze Plated (B)
Oxidized Classic Gold (G)

Available Sizes (mm)
Length 407, Centres 295

Fixing Holes Sizes
Door 8mm, Glass 12mm

Specification Code
T2043 - 407 - finish

MEDIUM ENTRY PULLS *by Elmes of Japan*

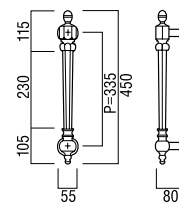
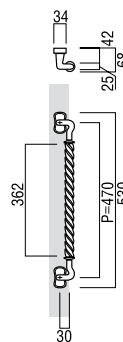
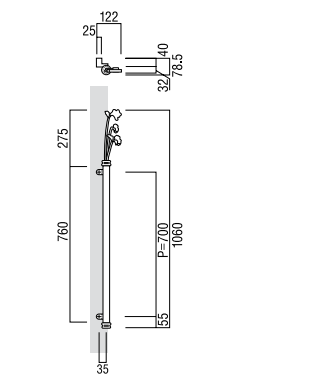
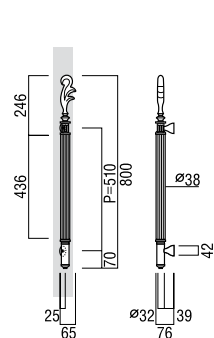
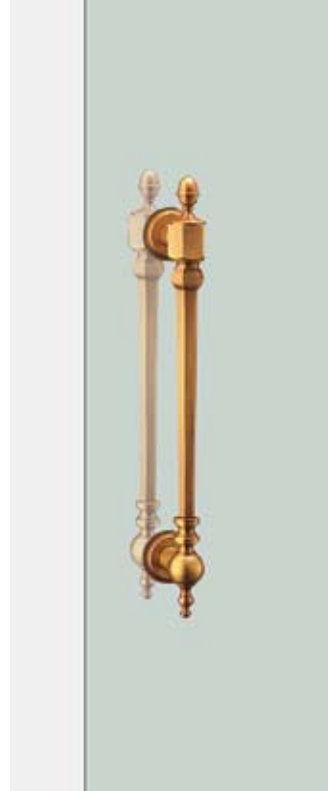

T3103

Base Material
Brass

Available Finish
Polished Brass (PB)

Australian Handing
Australian Left Hand (L)
Australian Right Hand (R)

Available Sizes (mm)
Length 800, Centres 510

Fixing Holes Sizes
Door 10mm, Glass 16mm

Specification Code
T3103 - 800 - PB - L
T3103 - 800 - PB - R

T3970

Base Material
Brass

Available Finish
Polished Brass and White Bronze
Plated & Cloisonne (PBC)

Australian Handing
Australian Left Hand (L)
Australian Right Hand (R)

Available Sizes (mm)
Length 1060, Centres 700

Fixing Holes Sizes
Door 10mm, Glass 16mm

Specification Code
T3970 - 1060 - PBC - L
T3970 - 1060 - PBC - R

T7250

Base Material
Brass

Available Finish
Polished Brass (PB)

Available Sizes (mm)
Length 530, Centres 470

Fixing Holes Sizes
Door 8mm, Glass 12mm

Specification Code
T7250 - 530 - PB

G822

Base Material
Cast Brass

Available Finish
Oxidized Golden Bronze (B)

Available Sizes (mm)
Length 450, Centres 335

Fixing Holes Sizes
Door 10mm, Glass 16mm

Specification Code
G822 - 450 - B

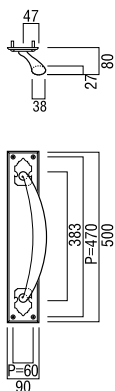

T3109

Base Material
Brass

Available Finish
Polished Brass & Brushed Brass (B)

Available Sizes (mm)
Length 500, Centres 470

Fixing Holes Sizes
Door 12mm

Specification Code
T3109 - 500 - B
Note: Not Suitable for Glass Doors

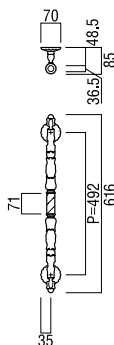

T2041

Base Material
Brass

Available Finish
Hairline Brass (HB)

Available Sizes (mm)
Length 616, Centres 492

Fixing Holes Sizes
Door 8mm, Glass 12mm

Specification Code
T2041 - 616 - HB

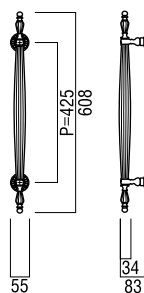

T836

Base Material
Brass

Available Finish
Polished Brass (PB)
Brass Oxidized Golden Bronze (O)

Available Sizes (mm)
Length 608, Centres 425

Fixing Holes Sizes
Door 8mm, Glass 12mm

Specification Code
T836 - 608 - finish

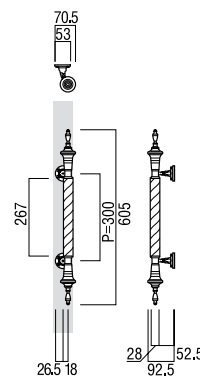

T8170

Base Material
Brass

Available Finish
Satin Brass (SB)

Available Sizes (mm)
Length 605, Centres 300

Fixing Holes Sizes
Door 10mm, Glass 16mm

Specification Code
T8170 - 605 - SB

The profound brilliancy of bronze increases
in elegance with the passage of time.

Bronze is loved throughout the world as ornamental
material. A strong point is the profound brilliancy born
from the high content of copper. Instil the room with
dignity and nobility; its elegance deepens with use.



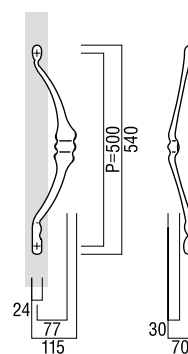
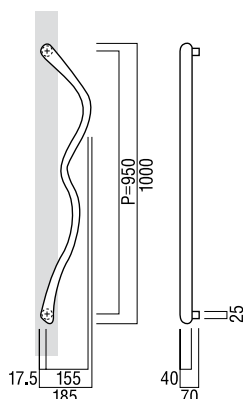
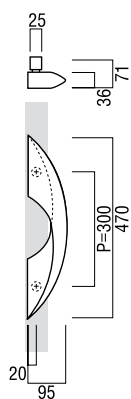
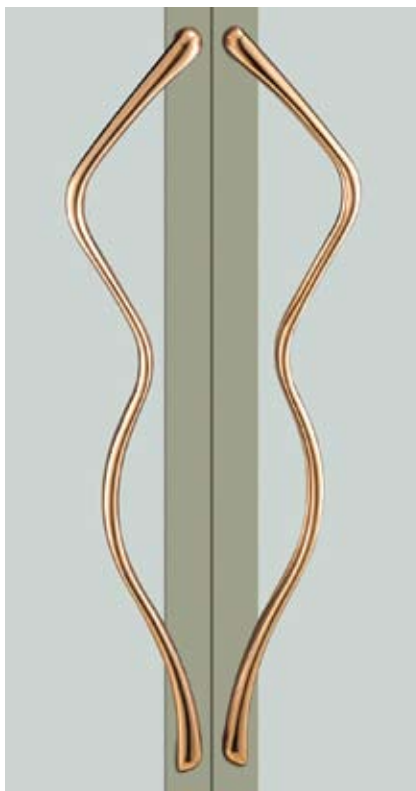

T1032

Base Material
Cast Bronze

Available Finish
Polished Bronze & Blast Bronze (B)

Australian Handing
Australian Left Hand (L)
Australian Right Hand (R)

Available Sizes (mm)
Length 470, Centres 300

Fixing Holes Sizes
Door 10mm, Glass 16mm

Specification Code
T1032 - 470 - B - L
T1032 - 470 - B - R

T1005

Base Material
Cast Bronze

Available Finish
Polished Bronze (B)

Australian Handing
Australian Left Hand (L)
Australian Right Hand (R)

Available Sizes (mm)
Length 1000, Centres 950

Fixing Holes Sizes
Door 10mm, Glass 16mm

Specification Code
T1005 - 1000 - B - L
T1005 - 1000 - B - R

T1029

Base Material
Cast Bronze

Available Finish
Polished Bronze (B)

Australian Handing
Australian Left Hand (L)
Australian Right Hand (R)

Available Sizes (mm)
Length 540, Centres 500

Fixing Holes Sizes
Door 10mm, Glass 16mm

Specification Code
T1029 - 540 - B - L
T1029 - 540 - B - R



Nickel silver lends a soft impression through the mass of the casting itself.

A matte satin finish on Nickel silver changes casting that is rich in nickel into a soft expression. By boldly challenging material that is tough to cast we achieved a feeling of volume that is not possible to reproduce via plating. Also available is a mirror finish that directly expresses the wonder of moulding this casting original.

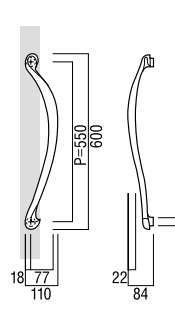
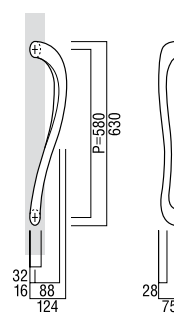
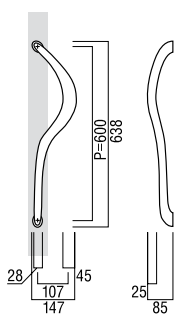
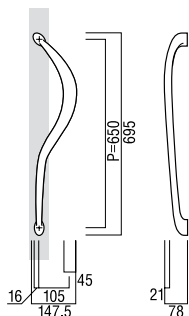
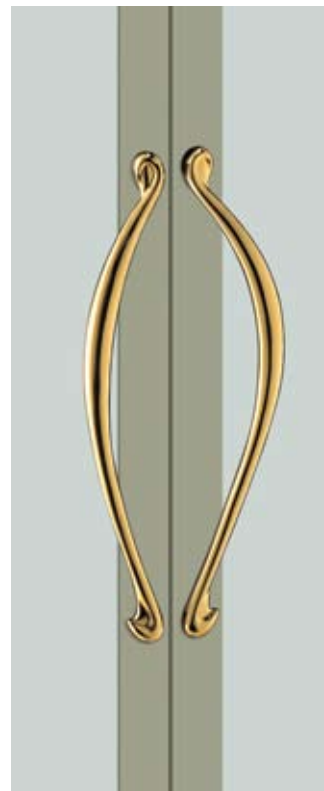
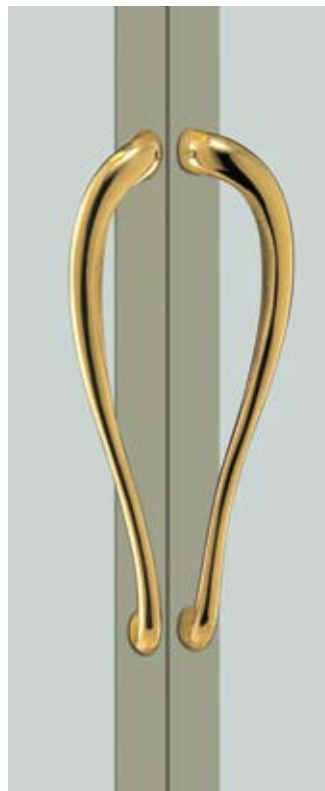
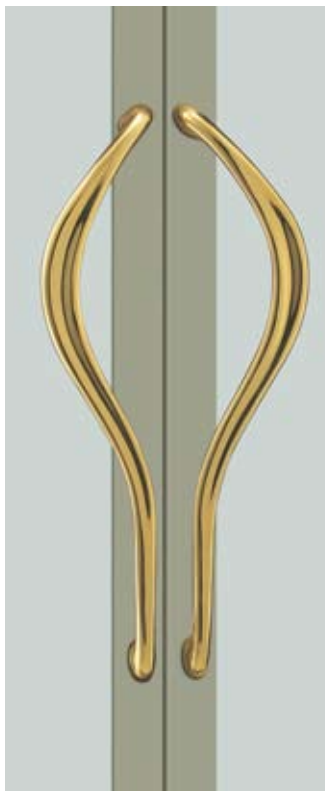

T1051

Base Material
Cast Nickel, Cast Brass

Available Finish
Satin Nickel Silver (S)
Polished Brass (PB)

Australian Handing
Australian Left Hand (L)
Australian Right Hand (R)

Available Sizes (mm)
Length 695, Centres 650

Fixing Holes Sizes
Door 10mm, Glass 16mm

Specification Code
T1051 - 695 - finish - L
T1051 - 695 - finish - R

T1033

Base Material
Cast Brass

Available Finish
Polished Brass (PB)

Australian Handing
Australian Left Hand (L)
Australian Right Hand (R)

Available Sizes (mm)
Length 638, Centres 600

Fixing Holes Sizes
Door 10mm, Glass 16mm

Specification Code
T1033 - 638 - finish - L
T1033 - 638 - finish - R

T1030

Base Material
Cast Brass

Available Finish
Polished & Blast Brass (PB)

Australian Handing
Australian Left Hand (L)
Australian Right Hand (R)

Available Sizes (mm)
Length 630, Centres 580

Fixing Holes Sizes
Door 10mm, Glass 16mm

Specification Code
T1030 - 630 - PB - L
T1030 - 630 - PB - R

T1028

Base Material
Cast Nickel, Cast Brass

Available Finish
Satin Nickel Silver (S)
Polished Brass (PB)

Australian Handing
Australian Left Hand (L)
Australian Right Hand (R)

Available Sizes (mm)
Length 600, Centres 550

Fixing Holes Sizes
Door 10mm, Glass 16mm

Specification Code
T1028 - 600 - finish - L
T1028 - 600 - finish - R

MEDIUM ENTRY PULLS *by Elmes of Japan*

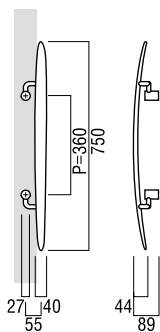

T987

Base Material
Brass

Available Finish
Polished Brass & Blast Brass (B)

Available Sizes (mm)
Length 750, Centres 360

Fixing Holes Sizes
Door 10mm, Glass 16mm

Specification Code
T987 - 750 - B

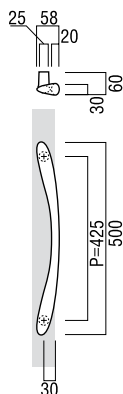

T3384

Base Material
Brass

Available Finish
Polished Brass (PB)

Available Sizes (mm)
Length 500, Centres 425

Fixing Holes Sizes
Door 10mm, Glass 16mm

Specification Code
T3384 - 500 - PB

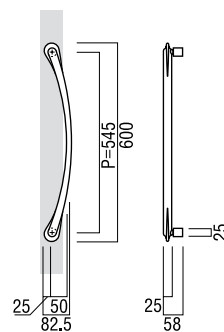

T3385

Base Material
Brass

Available Finish
Polished Brass (PB)

Available Sizes (mm)
Length 600, Centres 545

Fixing Holes Sizes
Door 10mm, Glass 16mm

Specification Code
T3385 - 600 - PB

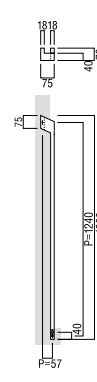
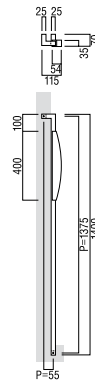
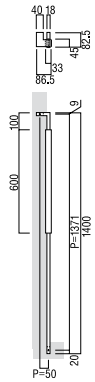
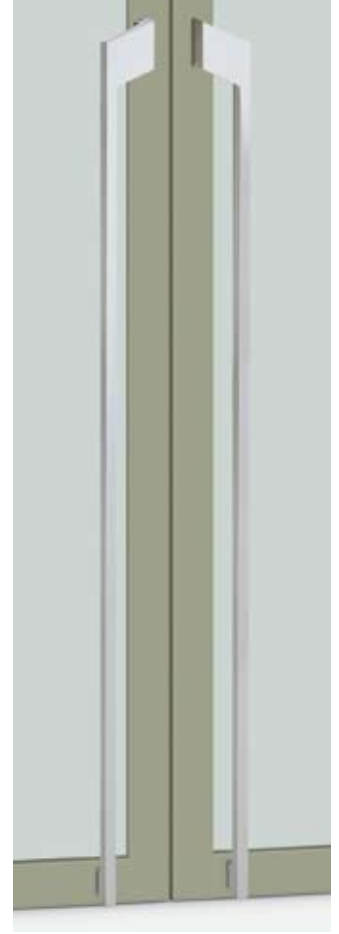

T3362

Base Material
Uniwood (Antibacterial
Compressed Wood) & Stainless Steel

Available Finish
Uni-Wood Grey & Polished Stainless (G)
Uni-Wood Scotch & Polished Stainless (S)

Australian Handing
Australian Left Hand (L)
Australian Right Hand (R)

Available Sizes (mm)
Length 1400, Centres 1371

Fixing Holes Sizes
Door 10mm, Glass 12mm

Specification Code
T3362 - 1400 - finish - L
T3362 - 1400 - finish - R

T3361

Base Material
Uniwood (Antibacterial
Compressed Wood) & Stainless Steel

Available Finish
Uni-Wood Grey & Polished S Steel (G)
Uni-Wood Scotch & Polished S Steel (S)

Australian Handing
Australian Left Hand (L)
Australian Right Hand (R)

Available Sizes (mm)
Length 1400, Centres 1375

Fixing Holes Sizes
Door 10mm, Glass 16mm

Specification Code
T3361 - 1400 - finish - L
T3361 - 1400 - finish - R

T7070

Base Material
Stainless Steel

Available Finish
Polished Stainless Steel (PS)

Australian Handing
Australian Left Hand (L)
Australian Right Hand (R)

Available Sizes (mm)
Length 1300, Centres 1240

Fixing Holes Sizes
Door 10mm, Glass 12mm

Specification Code
T7070 - 1300 - PS - L
T7070 - 1300 - PS - R

SEMI - LONG ENTRY PULLS *by Elmes of Japan*

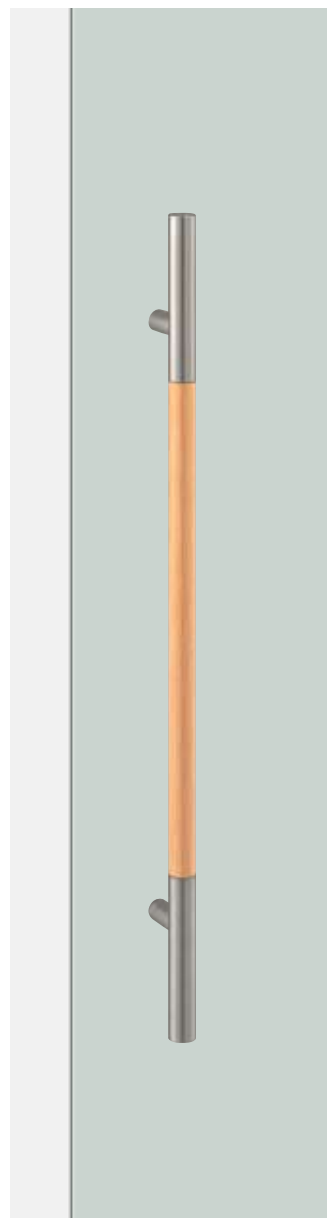
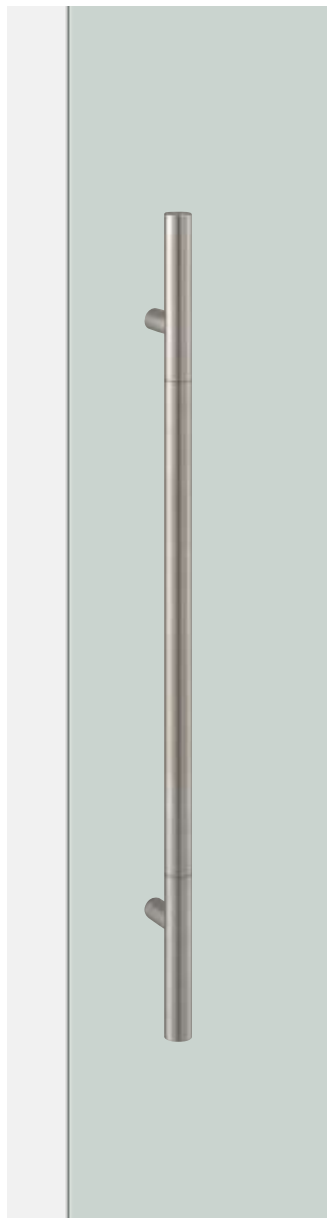
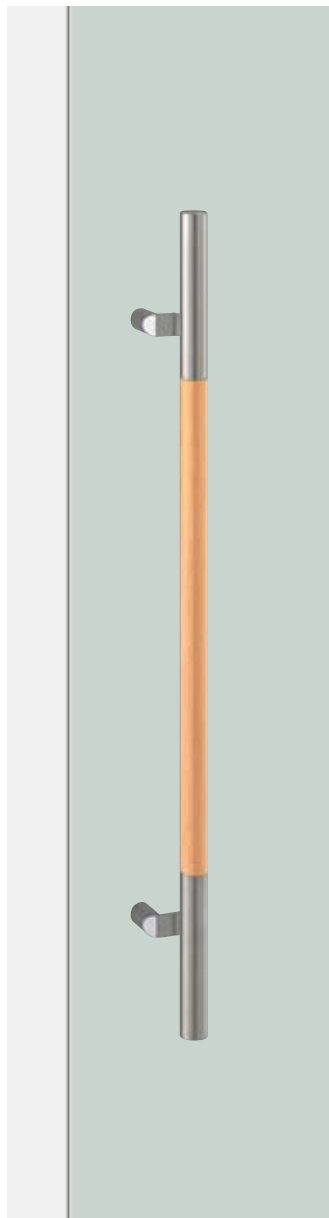
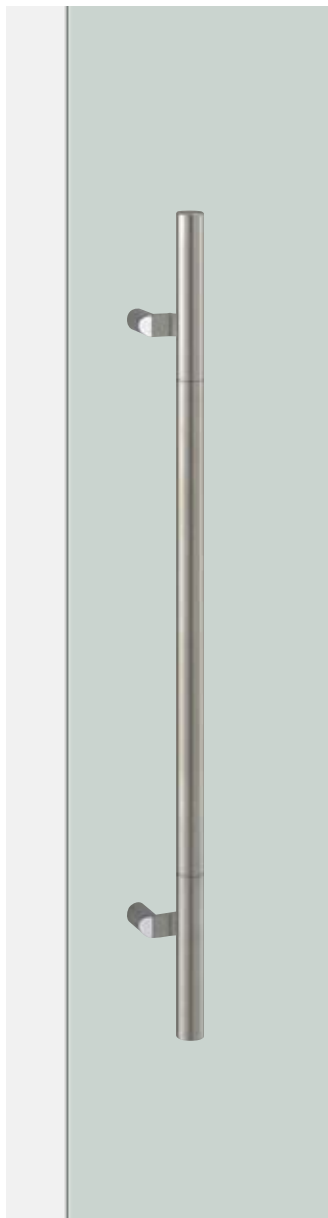

T2888

Base Material
Stainless Steel, Uniwood
(Antibacterial
Compressed Wood) with
Stainless Steel

Available Finish
Hairline Stainless Steel (H)
Uni-Wood White & Hairline
Stainless (W)

Available Sizes (mm)
Length 800, Centres 580

Fixing Holes Sizes
Door 10mm, Glass 16mm

Specification Code
T2888 - 800 - finish

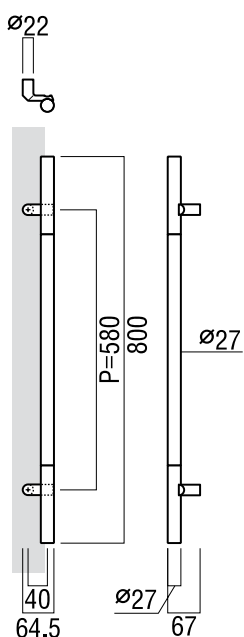

G2888

Base Material
Stainless Steel, Uniwood
(Antibacterial
Compressed Wood) with
Stainless Steel

Available Finish
Hairline Stainless Steel (H)
Uni-Wood White & Hairline
Stainless (W)

Available Sizes (mm)
Length 800, Centres 580

Fixing Holes Sizes
Door 8mm, Glass 12mm

Specification Code
G2888 - 800 - finish

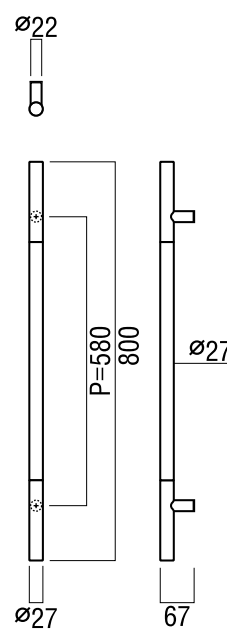

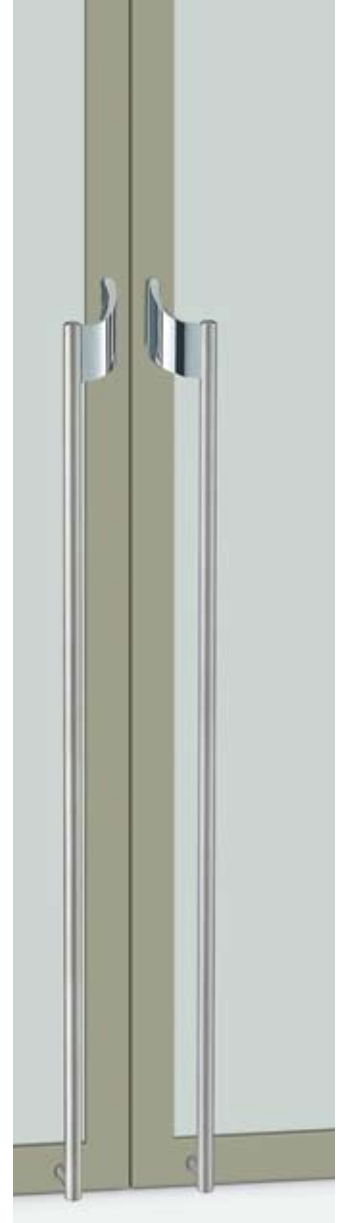
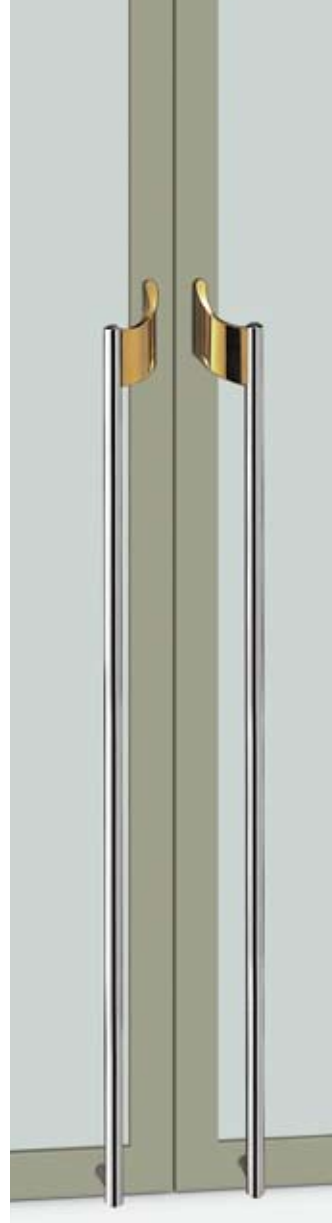
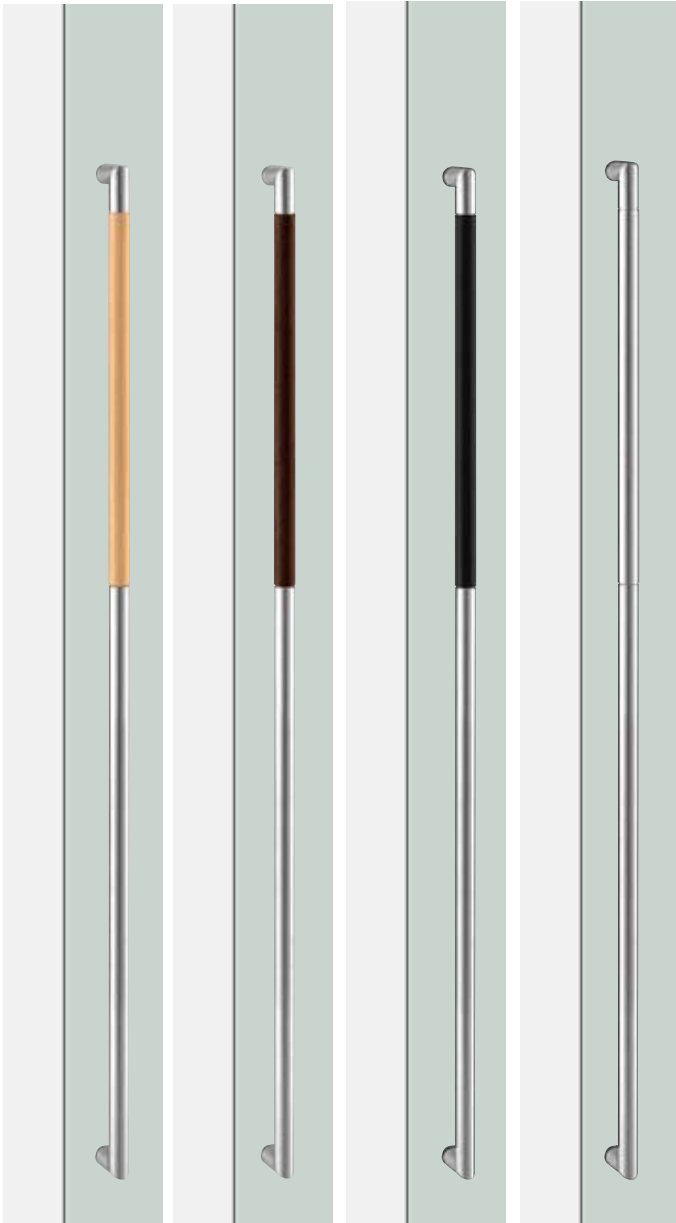

G2751

Base Material
Stainless Steel, Uniwood
(Antibacterial
Compressed Wood) with
Stainless Steel

Available Finish
Hairline Stainless Steel (H)
Uni-Wood White & Hairline
Stainless (W)
Uni-Wood Scotch & Hairline
Stainless (S)
Uni-Wood Black & Hairline
Stainless (B)

Available Sizes (mm)
Length 1300, Centres 1273

Fixing Holes Sizes
Door 10mm, Glass 16mm

Specification Code
G2751 - 1300 - finish

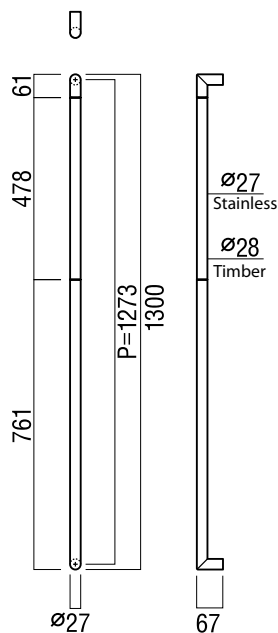

T9080

Base Material
Stainless Steel and Brass

Available Finish
Hairline Stainless & Bright
Chrome (SC)
Polished Stainless & Polished
Brass (SPB)

Australian Handing
Australian Left Hand (L)
Australian Right Hand (R)

Available Sizes (mm)
Length 1300, Centres 1200

Fixing Holes Sizes
Door 10mm, Glass 16mm

Specification Code
T9080 - 1300 - finish - L
T9080 - 1300 - finish - R

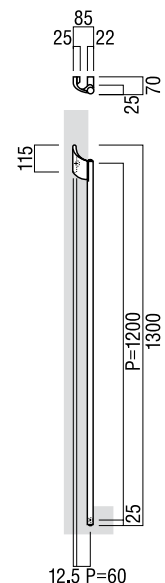

SEMI - LONG ENTRY PULLS *by Elmes of Japan*

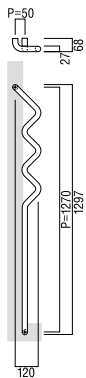
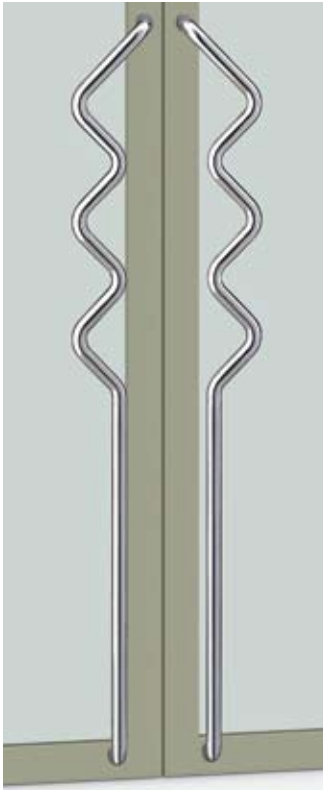

T2113

Base Material
Stainless Steel

Available Finish
Polished Stainless (PS)

Australian Handing
Australian Left Hand (L)
Australian Right Hand (R)

Available Sizes (mm)
Length 1297, Centres 1270

Fixing Holes Sizes
Door 10mm, Glass 16mm

Specification Code
T2113 - 1297 - PS - L
T2113 - 1297 - PS - R

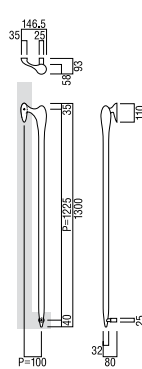
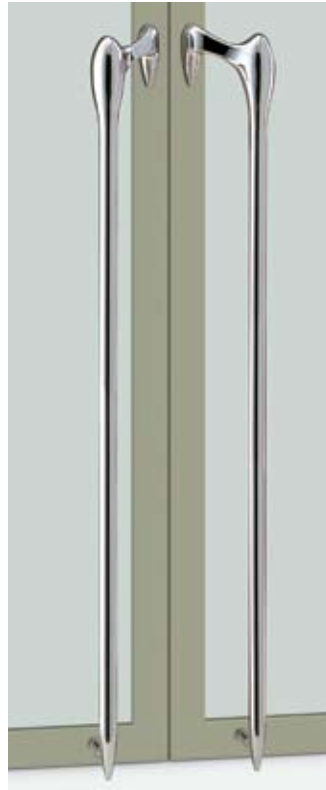

T3350

Base Material
Stainless Steel

Available Finish
Polished Stainless (PS)

Australian Handing
Australian Left Hand (L)
Australian Right Hand (R)

Available Sizes (mm)
Length 1300, Centres 1225

Fixing Holes Sizes
Door 10mm

Specification Code
T3350 - 1300 - PS - L
T3350 - 1300 - PS - R

Note: Not Suitable for Glass Doors

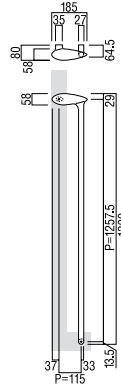
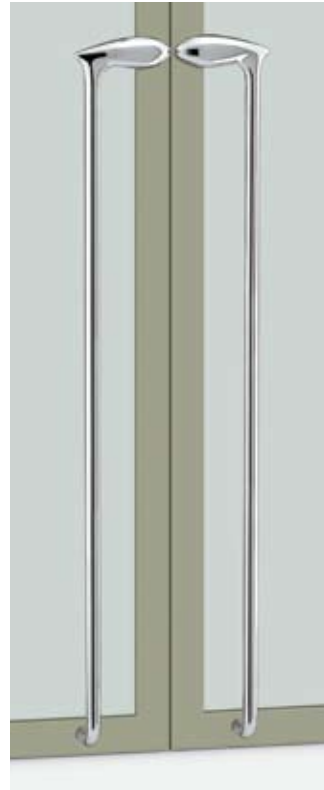

T3351

Base Material
Stainless Steel

Available Finish
Polished Stainless (PS)

Australian Handing
Australian Left Hand (L)
Australian Right Hand (R)

Available Sizes (mm)
Length 1300, Centres 1257.5

Fixing Holes Sizes
Door 10mm

Specification Code
T3351 - 1300 - PS - L
T3351 - 1300 - PS - R

Note: Not Suitable for Glass Doors

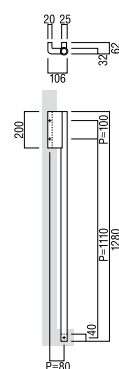
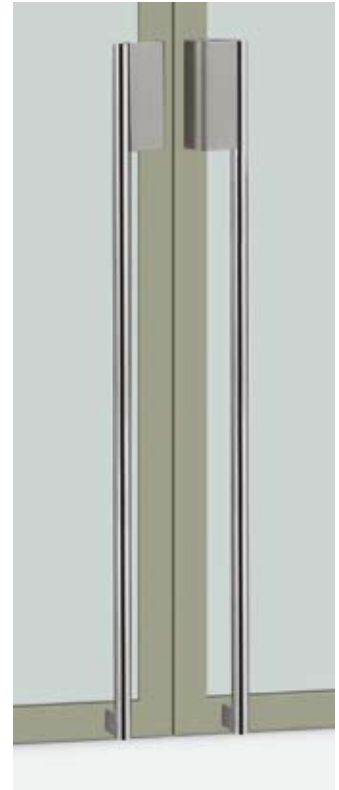

T9700

Base Material
Stainless Steel

Available Finish
Polished Stainless (PS)
Hairline Stainless Steel &
Polished Stainless Steel (HS)

Australian Handing
Australian Left Hand (L)
Australian Right Hand (R)

Available Sizes (mm)
Length 1280, Centres 1110

Fixing Holes Sizes
Door 10mm, Glass 16mm

Specification Code
T9700 - 1280 - finish - L
T9700 - 1280 - finish - R

SEMI - LONG ENTRY PULLS *by Elmes of Japan*

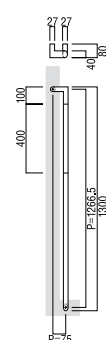
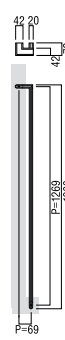
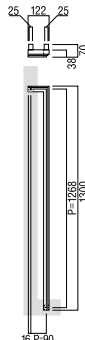
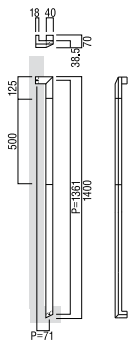
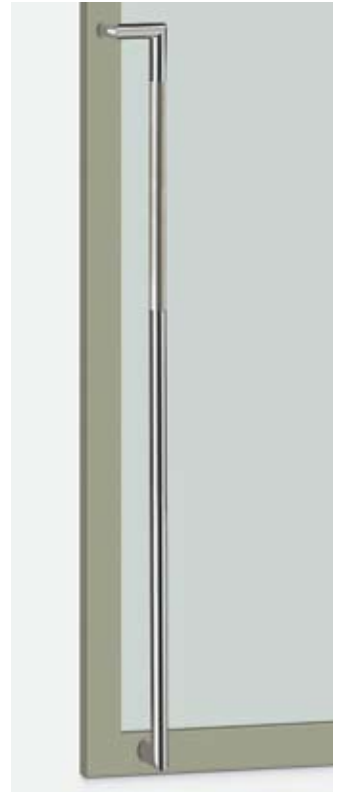
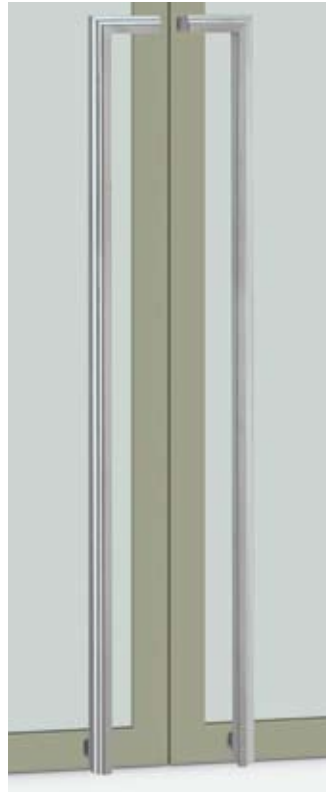
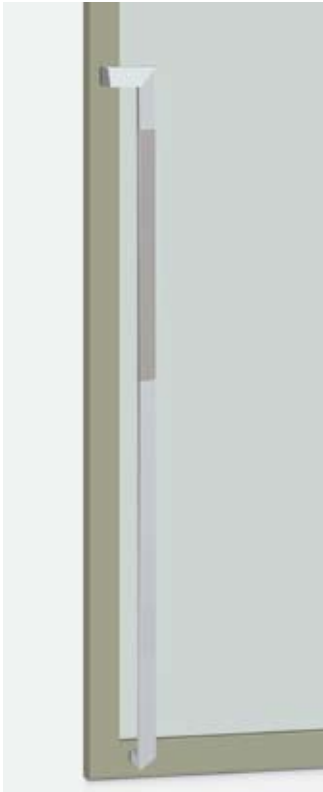

T3087

Base Material
Stainless Steel

Available Finish
Brushed Stainless and Polished Stainless (BPS)

Australian Handing
Australian Left Hand (L)
Australian Right Hand (R)

Available Sizes (mm)
Length 1400, Centres 1361

Fixing Holes Sizes
Door 10mm, Glass 12mm

Specification Code
T3087 - 1400 - BPS - L
T3087 - 1400 - BPS - R

T5789

Base Material
Stainless Steel

Available Finish
Hairline & Polished Stainless (HPS)

Australian Handing
Australian Left Hand (L)
Australian Right Hand (R)

Available Sizes (mm)
Length 1300, Centres 1268

Fixing Holes Sizes
Door 10mm, Glass 16mm

Specification Code
T5789 - 1300 - HPS - L
T5789 - 1300 - HPS - R

T5785

Base Material
Brass

Available Finish
Hairline and Polished Brass (B)

Australian Handing
Australian Left Hand (L)
Australian Right Hand (R)

Available Sizes (mm)
Length 1300, Centres 1269

Fixing Holes Sizes
Door 8mm, Glass 12mm

Specification Code
T5785 - 1300 - B - L
T5785 - 1300 - B - R

T2033

Base Material
Stainless Steel

Available Finish
Hairline and Polished Stainless (S)

Australian Handing
Australian Left Hand (L)
Australian Right Hand (R)

Available Sizes (mm)
Length 1300, Centres 1266.5

Fixing Holes Sizes
Door 10mm, Glass 16mm

Specification Code
T2033 - 1300 - S - L
T2033 - 1300 - S - R

SEMI - LONG ENTRY PULLS *by Elmes of Japan*

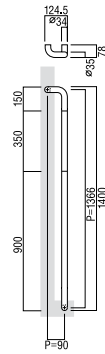
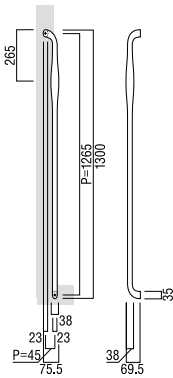
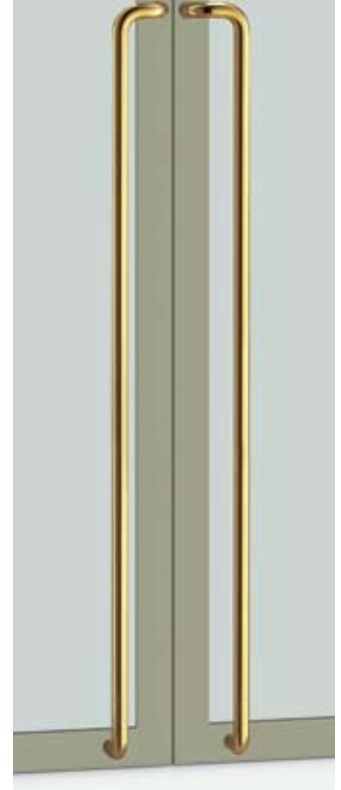
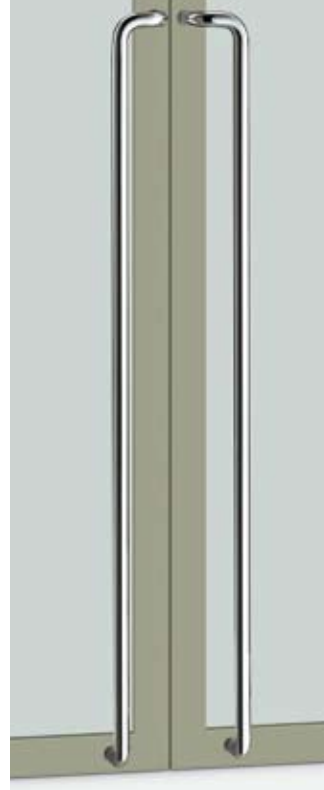
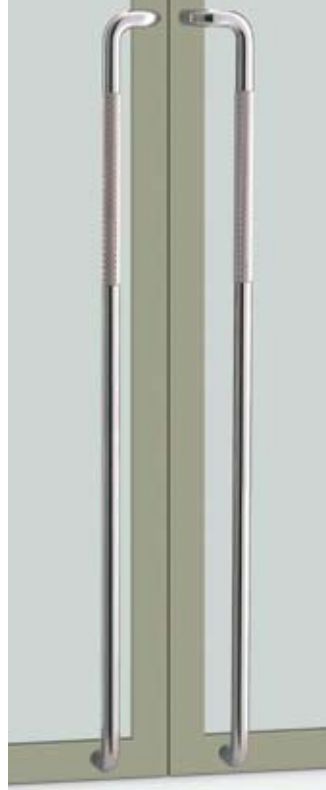
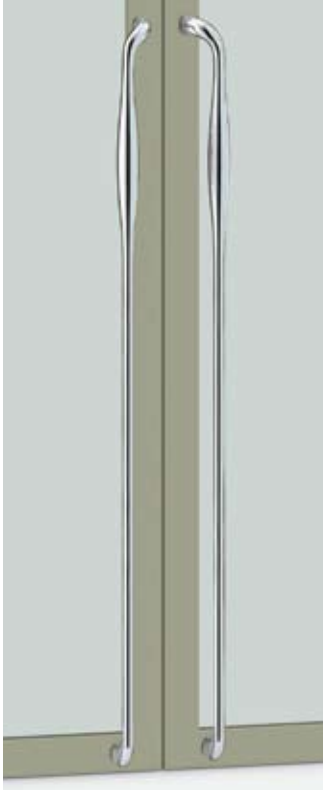

T3305

Base Material
Stainless Steel

Available Finish
Polished Stainless (P)

Australian Handing
Australian Left Hand (L)
Australian Right Hand (R)

Available Sizes (mm)
Length 1300, Centres 1265

Fixing Holes Sizes
Door 10mm, Glass 16mm

Specification Code
T3305 - 1300 - P - L
T3305 - 1300 - P - R

T2638

Base Material
Stainless Steel

Available Finish
Hairline and Polished Stainless (S)

Australian Handing
Australian Left Hand (L)
Australian Right Hand (R)

Available Sizes (mm)
Length 1400, Centres 1366

Fixing Holes Sizes
Door 10mm, Glass 16mm

Specification Code
T2638 - 1300 - S - L
T2638 - 1300 - S - R

T7036

Base Material
Stainless Steel, Brass

Available Finish
Polished Stainless (PS)
Polished Brass (PB)

Australian Handing
Australian Left Hand (L)
Australian Right Hand (R)

Available Sizes (mm)
Length 1300, Centres 1273

Fixing Holes Sizes
Door 10mm, Glass 16mm

Specification Code
T7036 - 1300 - finish - L
T7036 - 1300 - finish - R

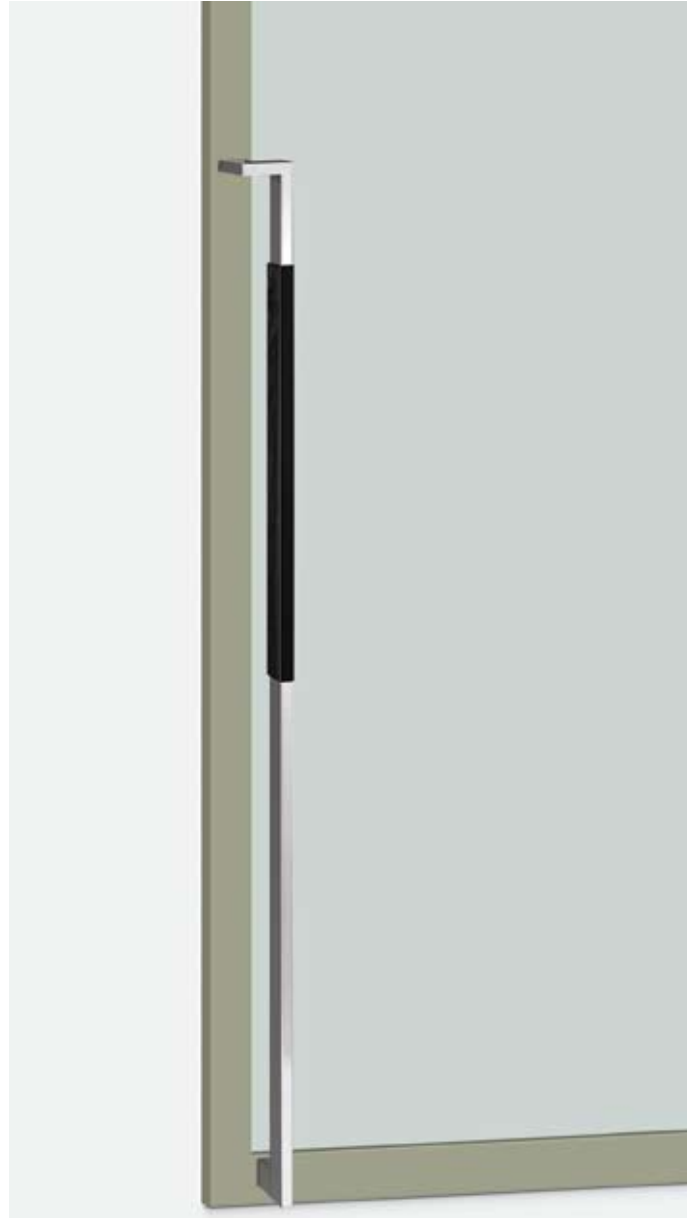
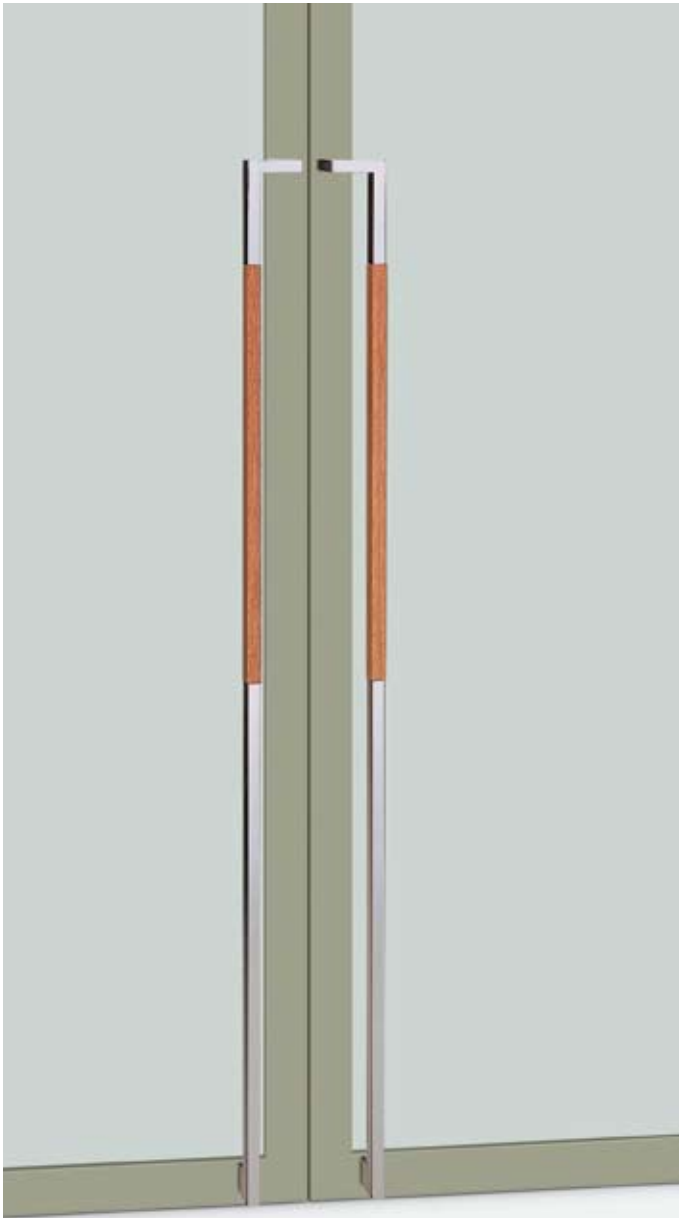

T617

Base Material

Uniwood (Antibacterial Compressed Wood) and Stainless Steel

Available Finish

Uniwood Brown and Polished Stainless Steel (B)
Uniwood Black and Polished Stainless Steel (BL)

Australian Handing

Australian Left Hand (L)
Australian Right Hand (R)

Available Sizes (mm)

Length 1500, Centres 1471

Fixing Holes Sizes

Door 8mm, Glass 12mm

Specification Code

T617 - 1500 - finish - L
T617 - 1500 - finish - R

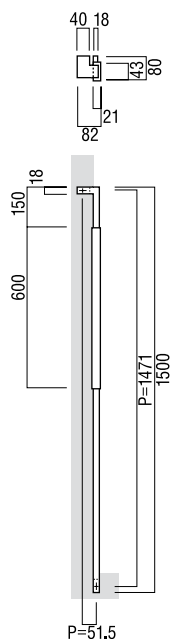

SEMI - LONG ENTRY PULLS *by Elmes of Japan*

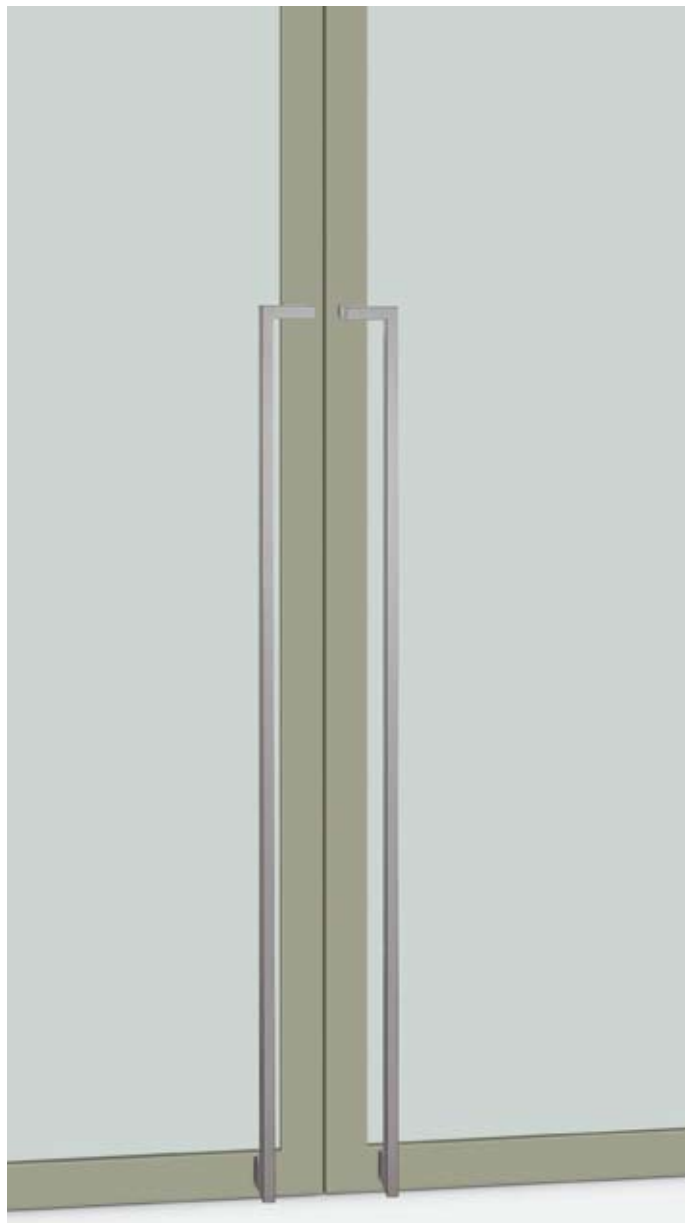
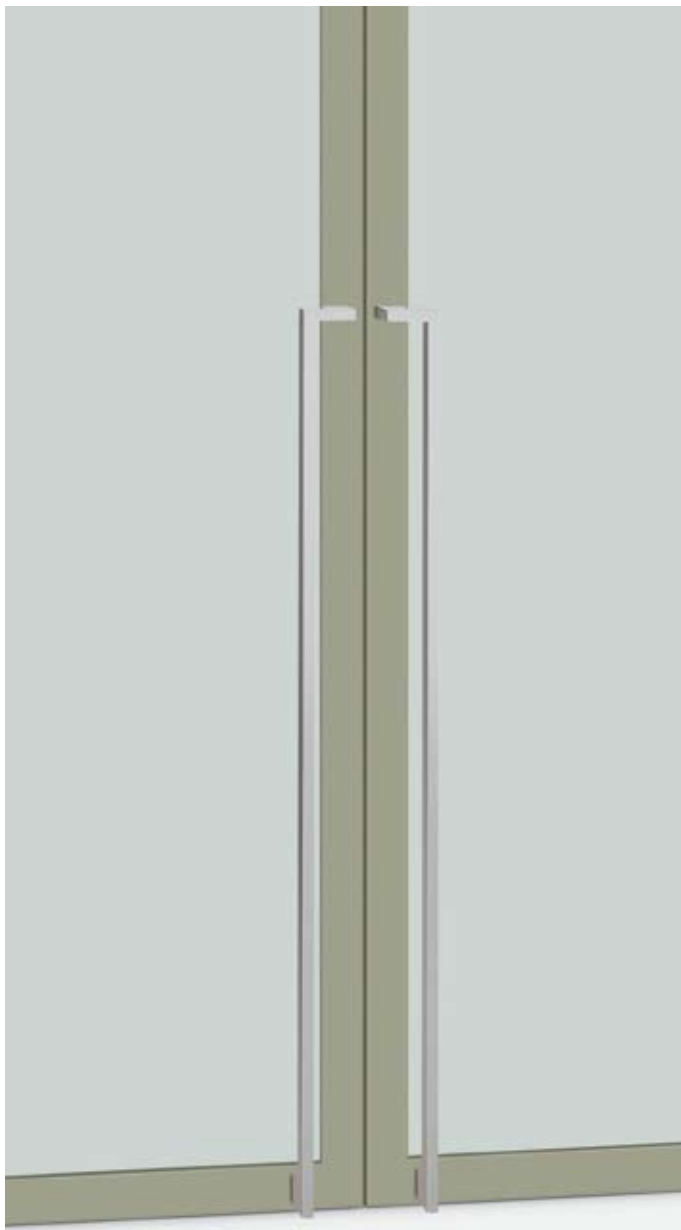

T610

Base Material
Stainless Steel

Available Finish
Hairline Stainless (H)
Polished Stainless (PS)

Australian Handing
Australian Left Hand (L)
Australian Right Hand (R)

Available Sizes (mm)
Length 1300, Centres 1271

Fixing Holes Sizes
Door 8mm, Glass 12mm

Specification Code
T610 - 1300 - finish - L
T610 - 1300 - finish - R

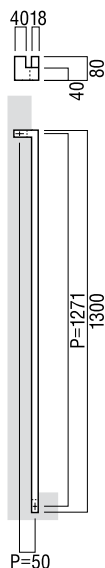

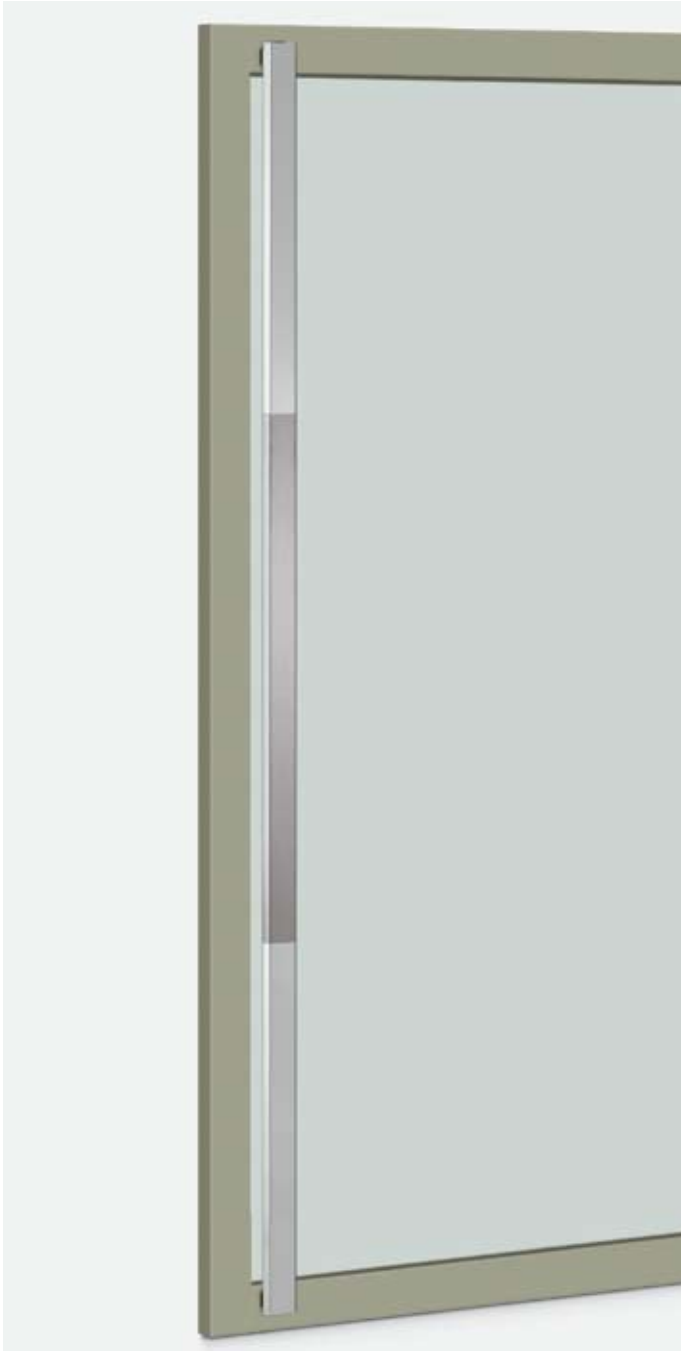

T8650

Base Material
Stainless Steel

Available Finish
Hairline & Polished Stainless Steel (HPS)

Available Sizes (mm)
Length 1965 to 2065
Centres 1925 to 2025

Fixing Holes Sizes
Door 10mm, Glass 16mm

Specification Code
T8650 - Size - HPS

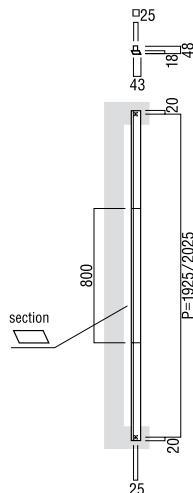

T8650-O

Base Material
Stainless Steel

Available Finish
Hairline & Polished Stainless Steel (HPS)

Available Sizes (mm)
Length 2101 to 2400
Centres: see diagram right

Fixing Holes Sizes
Door 10mm, Glass 16mm

Specification Code
T8650-O - Size - HPS

Note: O = Offset Version

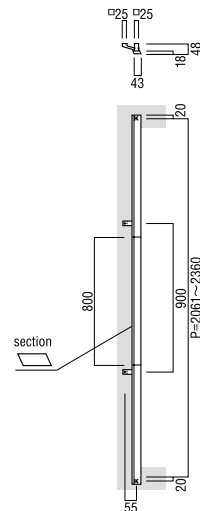



The existence of combinations of materials with the mount.....

A range of entry pulls with Stainless Steel as their base that pursues changes in expression by combining various materials and finishes. The mount, too, is a novel design that pursues a distinctive quality. By combining all elements we gain a symmetry between space, aesthetics and natural Stainless Steel.

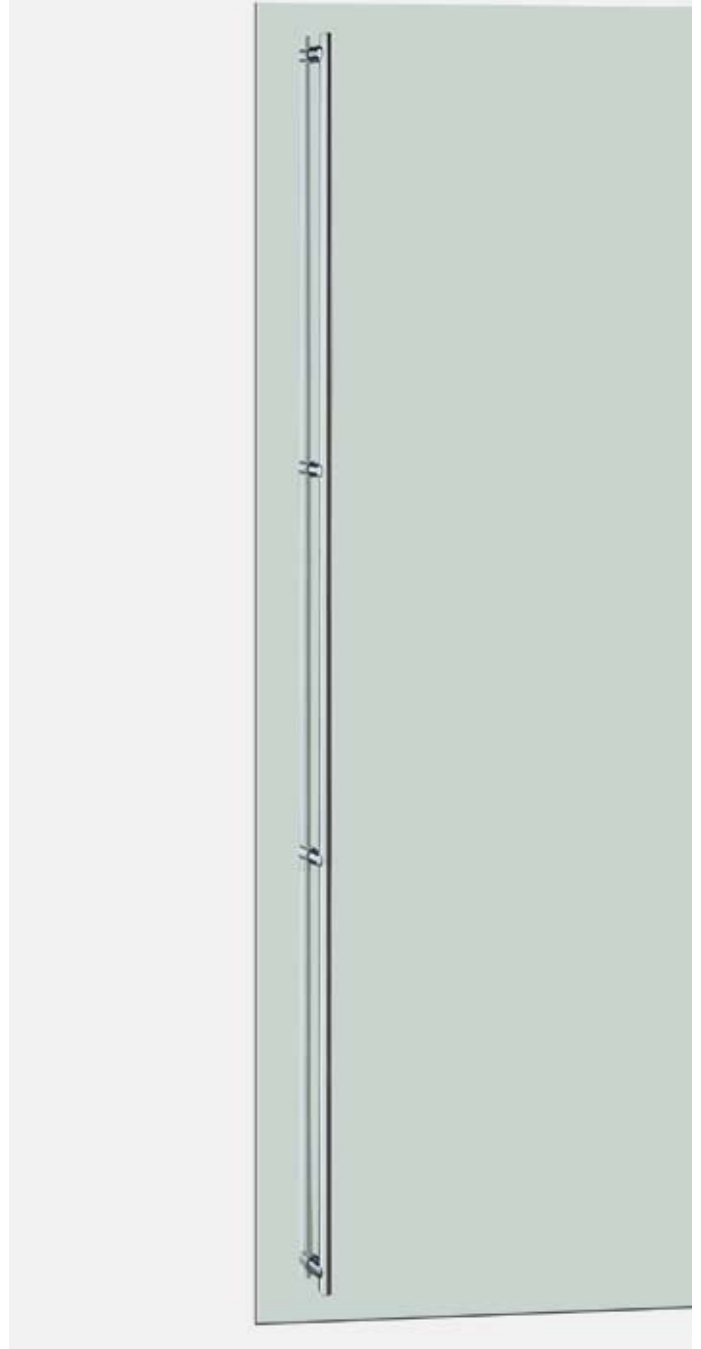

T561

Base Material
Stainless Steel

Available Finish
Polished Stainless Steel (PS)

Available Sizes (mm)
Length 1700 to 2400
Centres: see diagram to right

Fixing Holes Sizes
Door 8mm, Glass 12mm

Specification Code
T561 - Size - PS

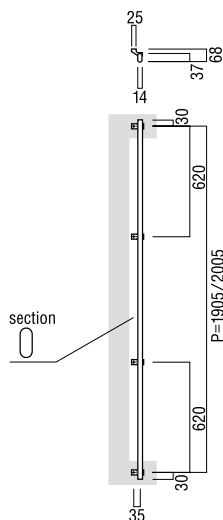

G561

Base Material
Stainless Steel & Brass

Available Finish
Polished Stainless Steel with
Bright Chrome Legs (PS)

Available Sizes (mm)
Length 1700 to 2400
Centres: see diagram above

Fixing Holes Sizes
Door 10mm, Glass 16mm

Specification Code
G561 - Size - PS

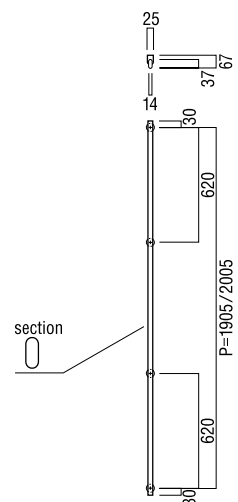

LARGE ENTRY PULLS *by Elmes of Japan*

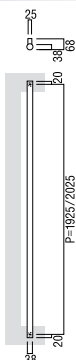
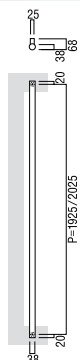
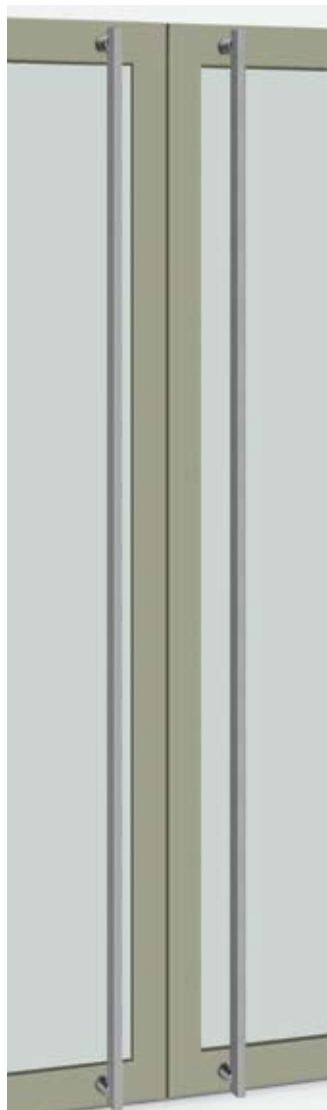
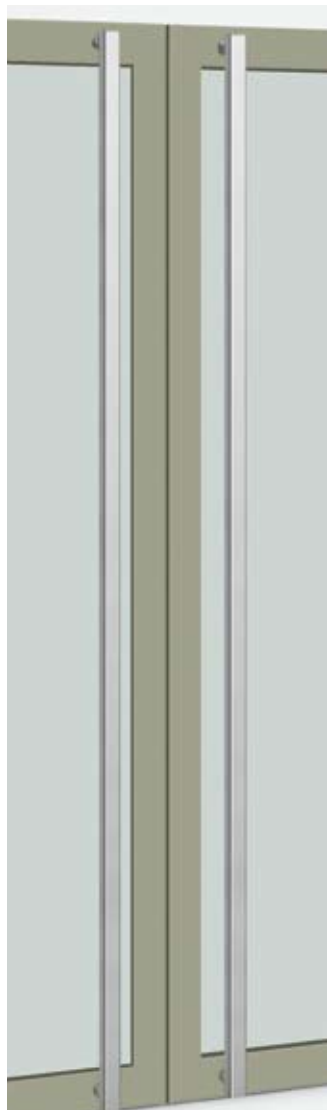
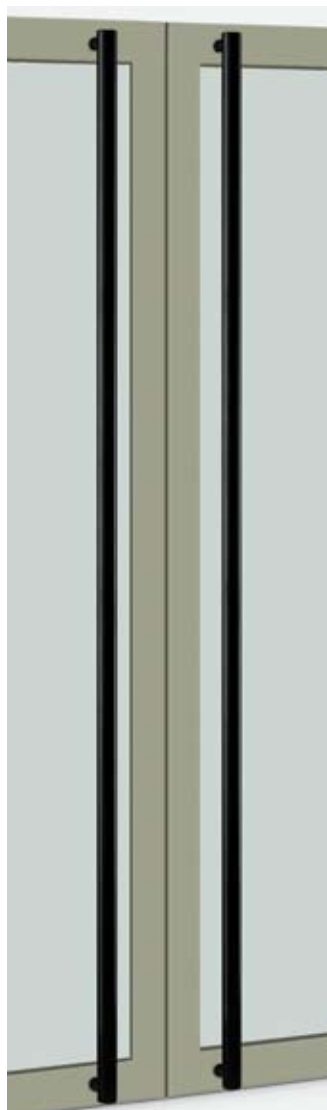
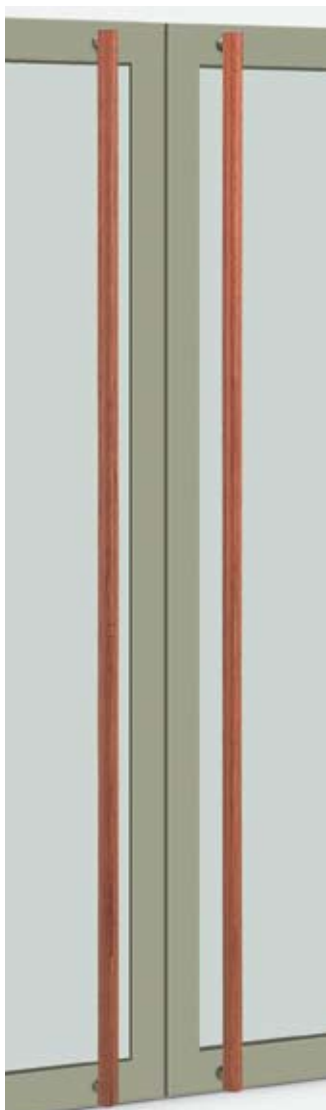

T51

Base Material
Stainless Steel, Brass, Uniwood (Antibacterial Compressed Wood) and Stainless Steel

Available Finish
Hairline Stainless Steel (H)
Polished Brass (PB)
Uni-Wood Brown and Hairline Stainless Legs (B)
Uni-Wood Black and Stainless Black Oxidized Legs (BL)

Available Sizes (mm)
Length 1700 to 2400mm, Centres 1660 to 2360mm for (HS Model only)
Length 1700 to 2100mm, Centres 1660 to 2060mm for (All other Models)

Fixing Holes Sizes
Door 10mm, Glass 16mm

Specification Code
T51 - Length - finish

T55

Base Material
Stainless

Available Finish
Polished Stainless Steel (P)

Available Sizes (mm)
Length 1700 to 2400mm
Centres 1660 to 2360mm

Fixing Holes Sizes
Door 10mm, Glass 16mm

Specification Code
T55 - Length - P

T61

Base Material
Stainless and Brass

Available Finish
Hairline Stainless Steel with Bright Chrome Legs (PC)

Available Sizes (mm)
Length 1700 to 2400mm
Centres 1660 to 2340mm

Fixing Holes Sizes
Door 10mm, Glass 16mm

Specification Code
T61 - Length - PC

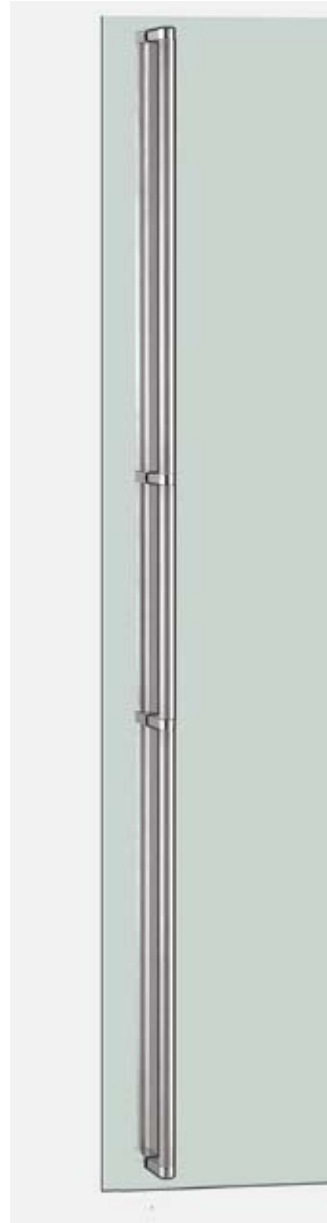

T2850

Base Material
Stainless Steel, Leather & Stainless Steel

Available Finish
Hairline & Polished Stainless Steel (HPS)
Black Leather & Hairline Stainless Steel with Polished Stainless Steel (B)

Available Sizes (mm)
Length 1679 to 2379mm
Centres 1660 to 2360mm

Fixing Holes Sizes
Door 8mm, Glass 12mm

Specification Code
T2850 - length - finish

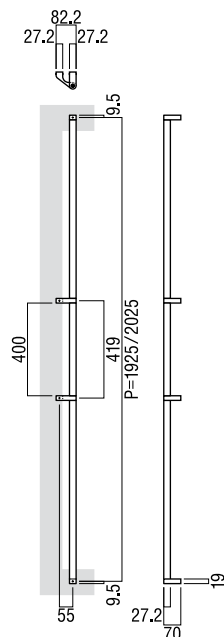

G2850

Base Material
Stainless Steel, Leather & Stainless Steel

Available Finish
Hairline & Polished Stainless Steel (HPS)
Black Leather & Hairline Stainless Steel with Polished Stainless Steel (B)

Available Sizes (mm)
Length 1679 to 2379mm
Centres 1660 to 2360mm

Fixing Holes Sizes
Door 8mm, Glass 12mm

Specification Code
G2850 - length - finish

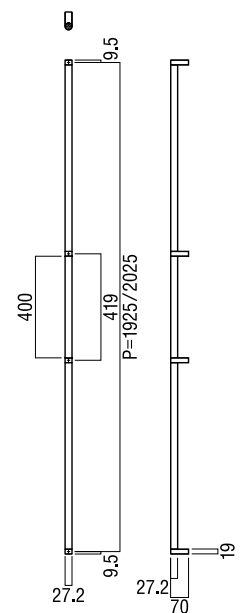



G2681

Base Material

Uniwood (Antibacterial Compressed Wood) and Stainless Steel

Available Finish

- Uni-Wood White & Coating Black & Stainless Steel Oxidized Black legs (W)
- Uni-Wood Grey & Coating Black & Stainless Steel Oxidized Black legs (G)
- Uni-Wood Brown & Coating Black & Stainless Steel Oxidized Black legs (B)
- Uni-Wood Red & Coating Black & Stainless Steel Oxidized Black legs (R)
- Uni-Wood Scotch & Coating Black & Stainless Steel Oxidized Black legs (S)

Available Sizes (mm)

- Length 2025, Centres 1300mm
- Length 1925, Centres 1200mm
- Length 700, Centres 425mm

Fixing Holes Sizes

- Door 10mm, Glass 16mm
- Door 8mm, Glass 12mm (700mm Long Model Only)

Specification Code

G2681 - length - finish

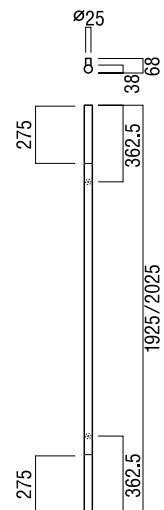

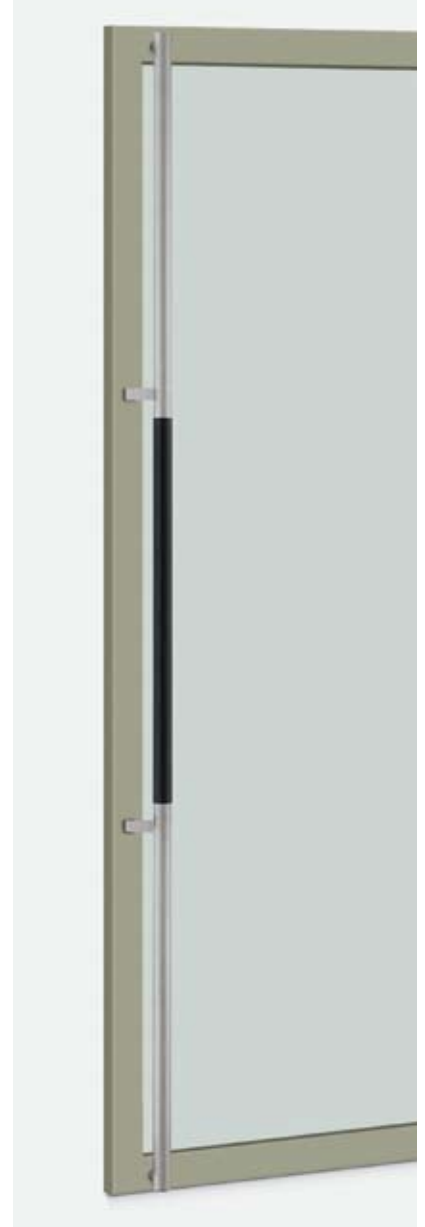
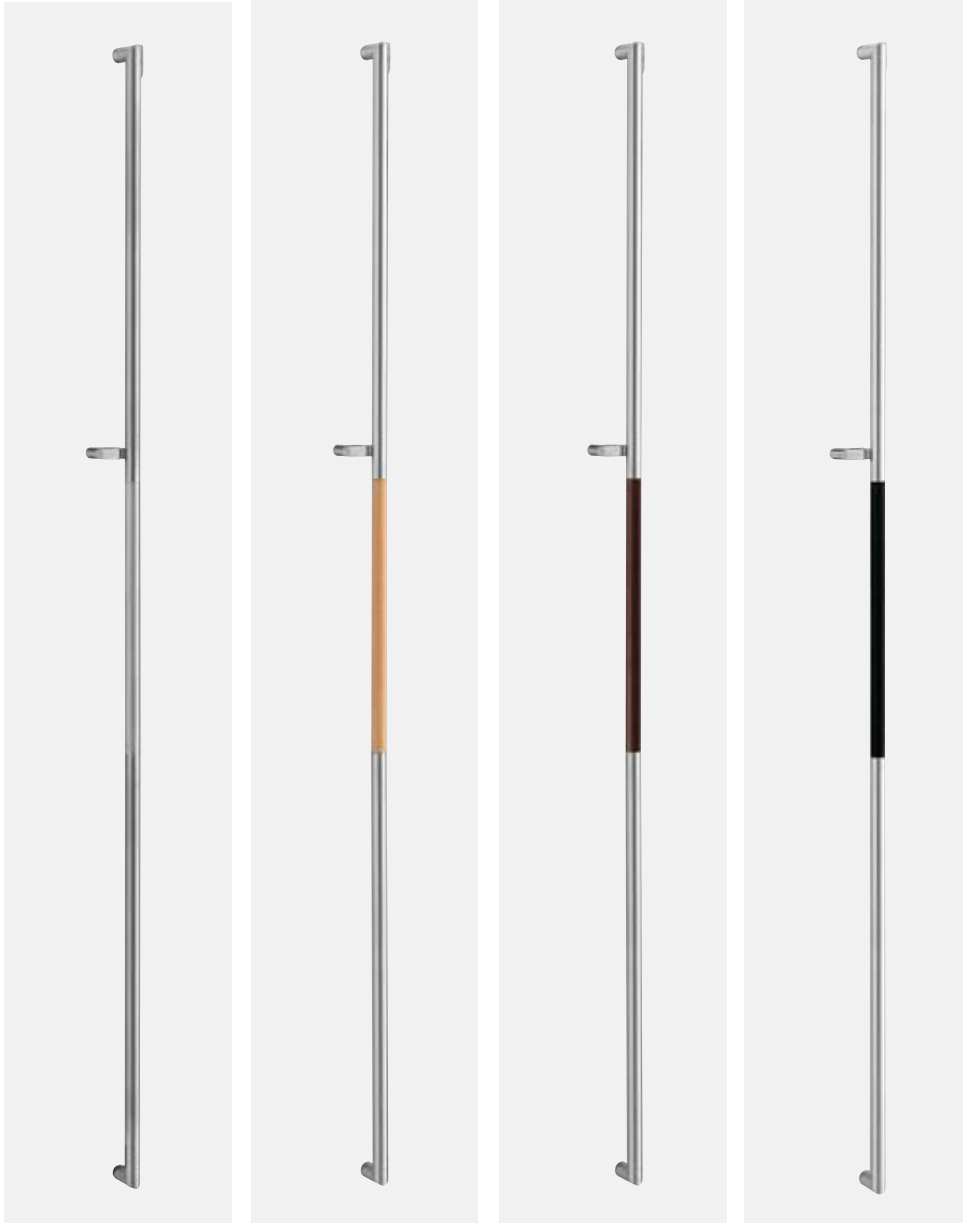

T2752

Base Material
Stainless Steel,
Uniwood (Antibacterial Compressed Wood) with Stainless Steel

Available Finish
Hairline & Polished Stainless Steel (HPS)
Uni-Wood White & Hairline & PolishStainless Steel (W)
Uni-Wood Scotch & Hairline & Polished Stainless Steel (S)
Uni-Wood Black & Hairline & Polished Stainless Steel (B)

Australian Handing
Australian Left Hand (L)
Australian Right Hand (R)

Available Finish
Length 1760 to 2370mm
Centres 1660 to 2360mm

Fixing Holes Sizes
Door 10mm, Glass 16mm

Specification Code
T2752 - center - finish - L
T2752 - center - finish - R

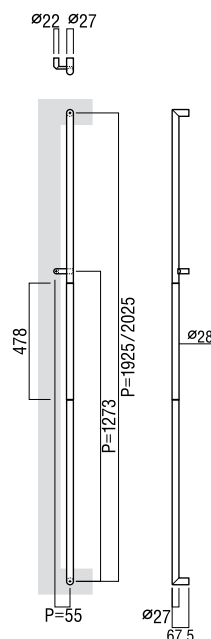

T62

Base Material
Uniwood (Antibacterial Compressed Wood) and Stainless Steel

Available Finish
Uni-Wood Black & Stainless Steel
Hairline (B)
Uni-Wood Black & Stainless Steel,
Chromophore
Shadow Brown (CB)

Available Sizes (mm)
Length 2065, Centres
2025mm

Fixing Holes Sizes
Door 10mm, Glass
16mm

Specification Code
T62 - length - finish

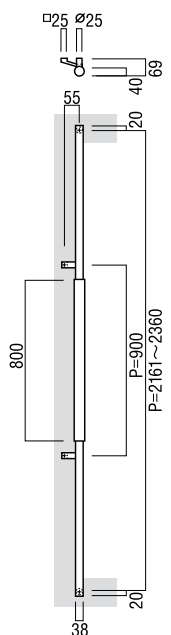

Entry Door Pulls

A front door, boardroom door or even just a meeting room door. It's the first and last thing you see, and touch when you enter or exit. It allows you to pass from one environment to another, without it we could not function. The door, it's a focal point in movement.

Making it look the part, standing out from the rest can be as simple as choosing a stylish and quality entry door pull. It can transform a plain door into a feature door. Lever handles have their place but the right entry pull can truly enhance an environment.

Ideally priced for large projects: Call for project pricing

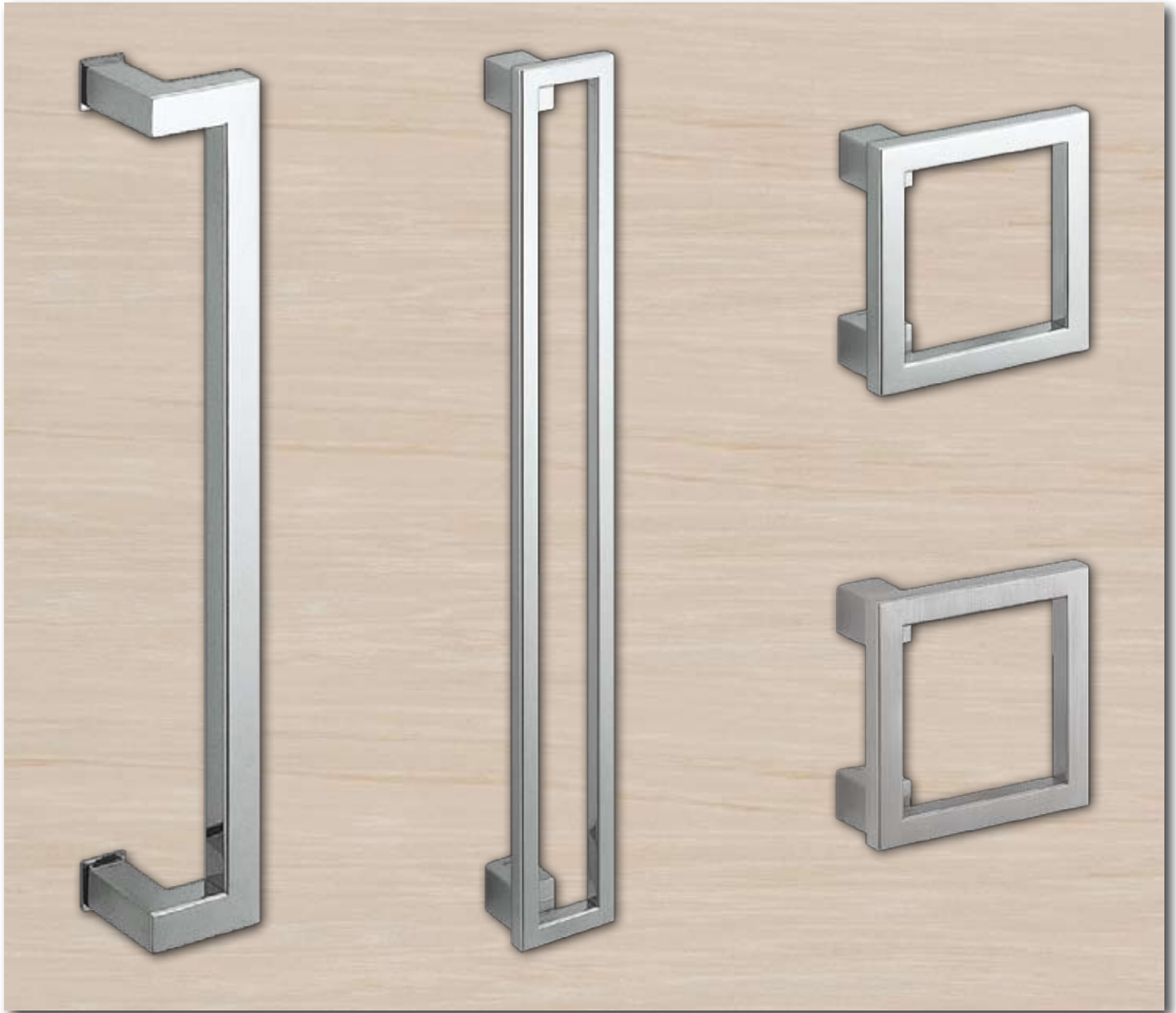

BEP01

Manufacturer

Elmes of Japan

Available Finish

Satin Stainless (SS)

Polished Stainless (PS)

Specification Code

Model	Finish
BEP01	SS/PS

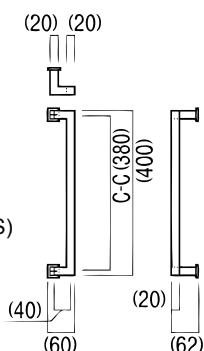

BEP02

Manufacturer

Elmes of Japan

Available Finish

Satin Stainless (SS)

Polished Stainless (PS)

Specification Code

Model	Finish
BEP02	SS/PS

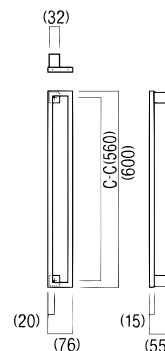

BEP03

Manufacturer

Elmes of Japan

Available Finish

Satin Stainless (SS)

Polished Stainless (PS)

Specification Code

Model	Finish
BEP03	SS/PS

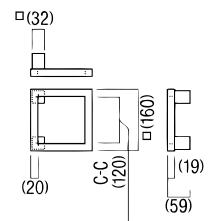



Ideally priced for large projects: Call for project pricing

BEP04

Manufacturer
Didheya, Spain

Available Finish
Satin Stainless (SS)
Polished Stainless (PS)

Available Sizes (mm)

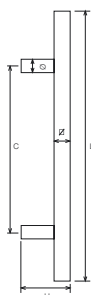

Code	ø	C	L	H
- 01	25	400	600	
- 02	25	600	800	
- 03	25	800	1000	
- 06		Custom Sizes		

Specification Code - Sold as Sets

Model	Finish	Size
BEP04 -	SS/PS	01

BEP05

Manufacturer
Didheya, Spain

Available Finish
Satin Stainless (SS)
Polished Stainless (PS)

Available Sizes (mm)

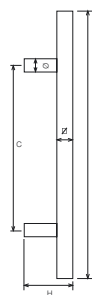

Code	ø	C	L	H
- 01	20	200	300	65
- 02	20	300	450	65
- 03	30	300	600	90
- 04	30	500	800	90
- 05		Custom Sizes		

Specification Code - Sold as Sets

Model	Finish	Size
BEP05 -	SS/PS	01

BEP06

Manufacturer
Didheya, Spain

Available Finish
Satin Stainless (SS)
Polished Stainless (PS)

Available Sizes (mm)

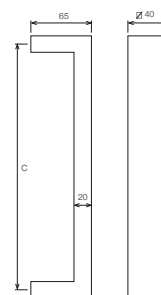

Code	ø	C	L	H
- 01	40	200	230	65
- 02	40	300	330	65
- 03	40	500	530	65
- 04		Custom Sizes		

Specification Code - Sold as Sets

Model	Finish	Size
BEP06	SS/PS	01

*Ideally priced for large projects:
Call for project pricing*



BEP07

Base Material
Stainless

Available Finish
Hairline Stainless Steel (SS)
Polished Stainless Steel (PS)

Available Sizes (mm)

Code	Ø	C	L	H
- 01	15	150	165	55
- 02	15	200	215	55
- 03	15	300	315	55
- 04	20	200	220	65
- 05	20	250	270	65
- 06	20	300	320	65
- 07	30	250	280	90
- 08	30	350	380	90
- 09	30	600	630	90
- 10	30	800	830	90
- 10		Custom Sizes		

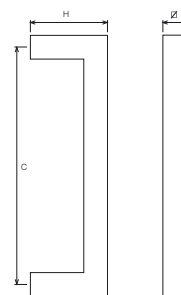

Specification Code - Sold as Sets

Model Finish Size
BEP07 - SS/PS 01



BEP17

Base Material
Stainless

Available Finish
Hairline Stainless Steel (SS)
Polished Stainless Steel (PS)

Available Sizes (mm)
See image

Specification Code
BEP17 - finish

Ideally priced for large projects: Call for project pricing

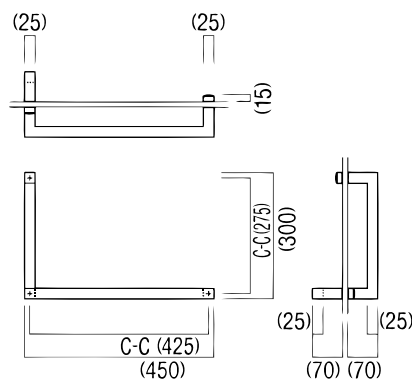



Bellevue Imports Pty Ltd
954 Glenhuntly Road, Caulfield South Victoria Australia 3162
Call Us Or Visit Our Web Site For Your Nearest Display Centre.

Phone: 1300 369 395
Fax: 03 9571 1347

Web: www.BellevueImports.com.au
eMail: Info@BellevueImports.com.au