



# BELLEVUE

ARCHITECTURAL

## Olivari Door Handles & Accessories

Architectural Door Hardware  
100% Made in Italy

SuperInox Finish: 10 -30 year Finish Guarantee

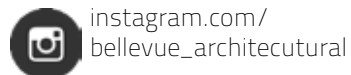
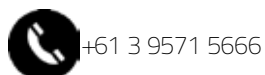

# Product Index

Page	Item	Page	Item
19	Our Designers	40	Door Handles
20	SuperInox Finishes	33	M175 - Onda
Page	Door Handles	41	M249 - Open
27	M255 - ABC - NEW	32	M170 - Orvieto
26	M216 - Adamant	25	M239 - Pitagora
39	M116 - Agata	31	M239 - Pitagora Q
30	M215 - Ala	23	M195 - Planet
33	M150 - Alexandra	27	M195 - Planet Q
26	M225 - Arc	39	M253 - Plume -NEW
38	M174 - Aster	31	M152 - Polo
32	M1AL - Atena Ligne	34	M235 - Radial
32	M1AP - Atena Panier	34	M128 - Raffaella
32	M1AR - Atena Rank	35	M186 - Sector
35	M185 - Aurelia	30	M194 - Selene
36	M164 - Aurora	34	M130 - Serenella
34	M208 - Beijing	34	M154 - Sibilla
31	M221 - Beta	41	M169 - Siena
25	M204 - Bios	26	M214 - Sky
23	M213 - Blade	33	M193 - Space
41	M178 - Blindo	25	M193 - Space Q
39	M163 - Bond	34	M190 - Stilo
37	M232 - Chelsea	37	M182 - Tecno
22	M248 - Chevron	33	M192 - Time
40	M125 - Chiara	25	M192 - Time Q
40	M114 - Clinica 140	35	M112 - Tizianella F
38	M181 - Club	24	M207 - Total
38	M183 - Comet	24	M228 - Trend
36	M236 - Conca	37	M242 - Twist
36	M245 - Crystal Royal	41	M108 - Uovo
36	M246 - Crystal Diamond	33	M251 - Virgola
26	M218 - Denver	27	M257 - Vola - NEW
23	M206 - Diana	40	M187 - Wind
22	M1DB- Diana Barley	42	M501 - Boma Nylon
22	M1DC- Diana Chevron	42	M507 - Iseo Nylon
22	M1DD- Diana Damier	42	M509 - Chiara Nylon
29	M256 - Diva - NEW		Fixed Sliding Door & 3 Point Turn
32	M243 - Dolce Vita	44	L131 / L132- Beta
24	M212 - Edge	44	L136 / L137- Lama
38	M167 - Emilia	44	L126 / L127 - Link
28	M229 - Euclide	44	L211 / L212- Lotus
25	M229 - Euclide Q	43	L221/ L222 - Lotus Q
30	M217 - Fin	45	L111 / L112 - Planet
38	M159 - Flaminia	45	L113 / L114 - Short
37	M172 - Futura	43	L121 / L122 - Planet Q
35	M105 - Garda	43	L123 / L124 - Q Short
37	M227 - Globe	45	L101 / L102 - Polo
39	M160 - Golia	45	L103 / L104- Short
41	M168 - Icaro		Door Knobs
22	M223 - Ice Cube	46	P163 - Bond
27	M254 - Icona - NEW	46	P178 - Blindo
29	M107 - Lama	47	P206 - Diana
29	M106 - Lama largeNEW	47	P146 - Edison 60
30	M176 - Laser	47	P147 - Edison 70
26	M211 - Lesmo	47	P148 - Edison 80
31	M200 - Link	47	P200 - Link
24	M222 - Living	47	P123 - Oscar
28	M197 - Logo	46	P195 - Planet Q
29	M238 - Lotus	46	P195 - Planet
24	M238 - Lotus Q	47	P120 - Roger
28	M231 - Lucy	46	P108 - Uovo
29	M258 - Lugano - NEW		Matching Accessories
30	M196 - Madison	48	Straight Entry Pulls
36	M237 - Marbella	49	Off-Set Entry Pulls
28	M252 - Marilyn	50	Snibs/eRelease
27	M259 - Milano Q - NEW	52	Plates & Escutcheons
23	M205 - Minerva	53	Flush Pulls
35	M226 - Moon	55	Privacy Flush Pulls
28	M234 - Nina	57	Door Stops
40	M173 - Nirvana		
39	M165 - Novella		

For as long as we can remember we have been striving to create, design and build. Our conscious effort to better ourselves; willingness to take risks has separated us from the rest.

*"We look, we touch, we consider and we are inspired"*

Since 1911 the Olivari Family of Italy has also been inspired. Inspired to design, create, build and inspire others.

For over 100 years the brand Olivari has represented nothing but the best in architecturally inspired door hardware, and accessories. The relationship between design, form, function, aesthetics and practicality are all symbiotic.

The creation of a door handle is more than the door handle itself; it's the connection between its form and its function; its personality and its aesthetic appeal; its design and the environment. Quality & design are cultural; inspired by generations past.

The importance of the handle cannot be underestimated. It is an indispensable object; it can hinder one's advance or facilitate movement in spaces of everyday life. Without it, we would have to redefine our entire way of life.

Relevant is also the handle size. It is a small sculpture; a point of difference of visual attraction on surfaces that are all too often anonymous or redundant. The opening and closing of a door is a highly symbolic gesture which has not lost its meaning over time; taking design by the hand.

A key distinction of the Olivari name is the significant number of interpretations of the "design" concept. The modern handle lives somewhere in the middle of the equation; geometry and the organic; the practical and the inspired.

A handles' form is unique; a challenge to design and create. It represents personality and function in its' truest form. Inspired designs, their materialization and transformation into Olivari handles is evident in the number of designs which exist in the Olivari range.

Just as important is the story of their creation. A significant number of world renowned architects and designers have accepted Olivari's invitation to design the handle; to bring to life the balance between geometry and the organic.

*"Inspiration is true design.....embrace it"*

New

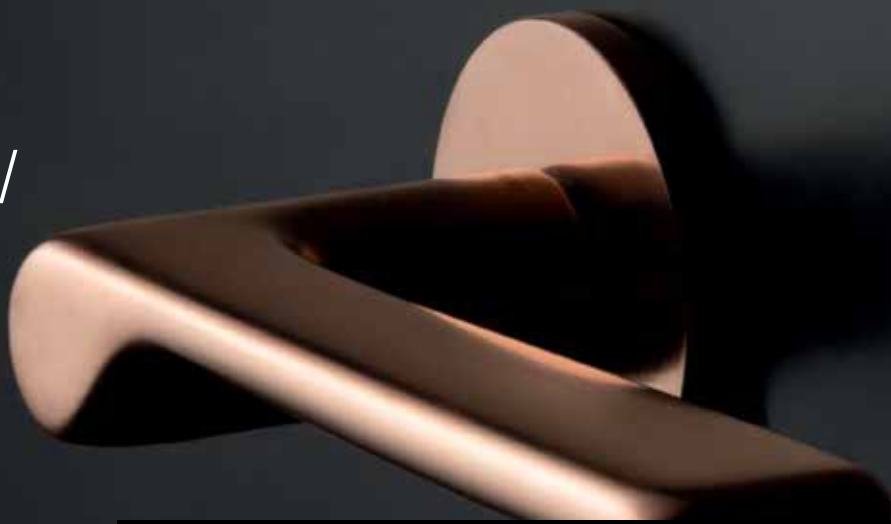

Plume M253R1 - Piero Lissoni 2018



## *Atena Panier*

M1APR1 by Studio Olivari 2016



## *Atena Rank*

M1ARR1 by Studio Olivari 2016

*Guilloché*

by Studio Olivari



*Diana Chevron*

M1DCSL1 by Studio Olivari 2016

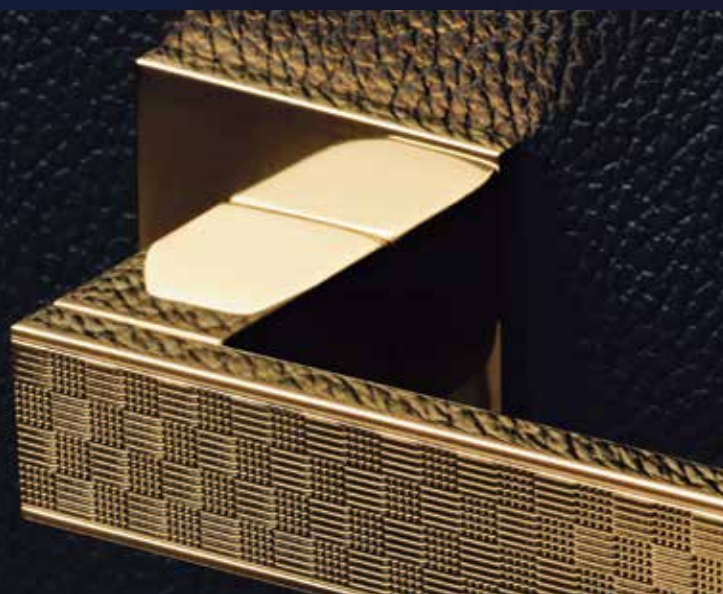
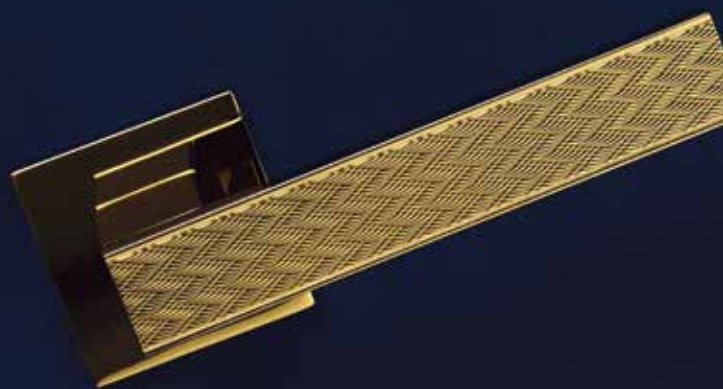

*Diana Damier*

M1DDSL1 by Studio Olivari 2016

# OLIVARI SUPERINOX ANTHRACITE

Guaranteed for 10 years not Pitt, Rub, Fade or T-Stain even in sea air **Over 60 + Designs**



Radial - M235R1



Link - M200R1



Planet - M195R1



Lucy - M231RL1



Lotus - M238RL1



Twist - M242RL1



Lama - M107R1



Nina - M234R1



Euclide - M229RL1



Aurelia - M185R1



Dolce Vita - M243RL1



Raffaella - M128R1



Beta - M221RL1



Conca - M236RL1



Blindo - M178R1



Total - M207S1



Planet Q - M195SL1



Bios - M204S1



Diana - M206S1



Lotus Q - M238SL1



Living - M222SL1



Euclide Q - M229SL1



Trend - M228SL1



**10 YEAR**  
Finish Guarantee



*Laser* M176R1 by Richard Sapper 1998



*Marilyn* M252RL1 by MAD Architects 2016



*Denver* M21851 by Daniel Libeskind 2009



New



Icona M254RL1 - Vincent Van Duysen 2018



*Ice Cube* M223S1 by Dominique Perrault 2010



*Lama* M107R1 by Gio Ponti 1956



*Lotus* M238SL 1 by Javier Lopez 2014



*Total* M207S1 by Rodolfo Dordoni 2007



*Euclide Q* M229SL1 by Nicola Novelletto 2012



*Twist* M242RL1 by Ben Van Berkel 2014



*Crystal Royal* M245RL1 by Marcel Wanders 2015



*Onda* M175R1 by Nicola Novelletto 1998



*Alexandra* M150R1 by F.A. Porsche 1989



*Lucy* M231RL1 by Patricia Urquiola 2012



*Arc* M225SL1 by Rodolfo Dordoni 2010



*Planet Q* M195S1 by Luca Casini 2006



*Living* M222SL1 by Dominique Perrault 2010



*Dolce Vita* M243RL1 by Marcel Wanders 2014





*Ala* M215R1 by Massimo Iosa Ghini 2009



*Nina* M234R1 by Daniel Libeskind 2012



*Trend* M228SL1 by Studio Olivari 2012



*Diana* M206S1 by Studio Olivari 2007



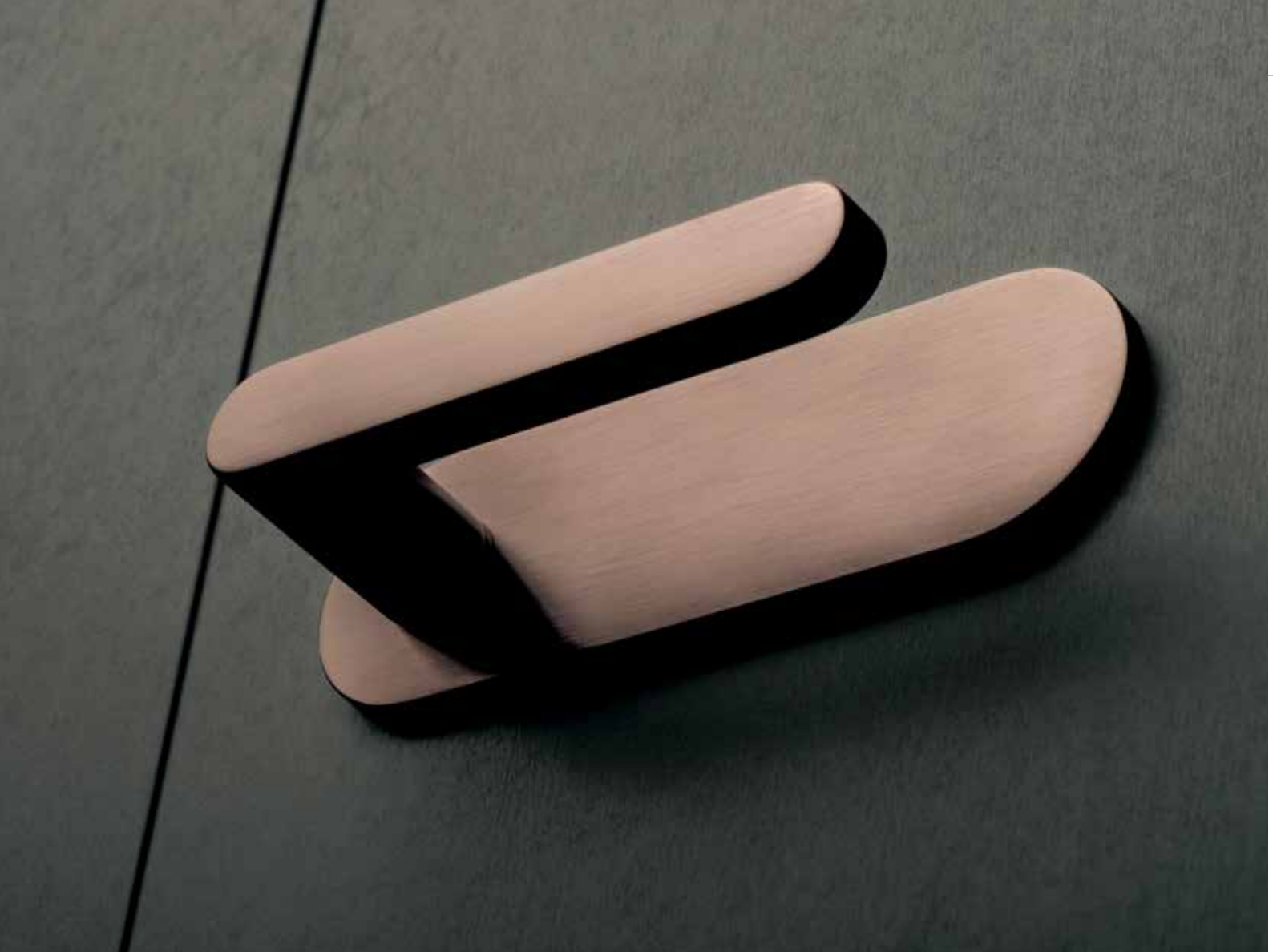





*Alessandro Mendini, Andrea Branzi, Ben Van Berkel, Claudio Bellini, Daniel Libeskind, Dominique Perrault, Enrico Marforio, Enzo Mari, Ferdinand A. Porsche, Franco Sargiani, Gilad Ron, Gio Ponti, Giorgetto Giugiaro, Giuliana Gramigna, GPA Monti, Ignazio Gardella, James Irvine, Javier Lopez, Jean Nouvel, Joe Colombo, Luca Casini, MAD Architects, Marcel Wanders, Massimo Iosa Ghini, Nicola Novelletto, Paolo Portoghesi, Patricia Urquiola, Penta Associati, Peter Marino, Piero Lissoni, Rem Koolhaas, Richard Sapper, Roberto Volonterio, Rodolfo Bonetto, Rodolfo Dordoni, Sergio Asti, Sergio Mazza, Shigeru Ban, Stefano Giovannoni, Steven Holl, Studio Olivari, Toyo Ito, Vico Magistretti, Zaha Hadid, Franco Albini*

Available on  
Standard & Low

# SuperInox\_finishes

Guaranteed for up to **30 years** not to pit, rub, tarnish, fade or lose its lustre even in sea air & high usage environments.

Too often we see tarnished door hardware due to the ravages of time, constant usage or corrosive sea air. SuperInox was specifically developed by Olivari of Italy to combat this industry problem. Now a door handle can look as good in 30 years as it did when first installed. Olivari believes that things should last. A lost art in today's disposable world.

*Welcome to the world of SuperInox.*

Vacuum metallisation (VM) is an extremely high end technology treatment process habitually employed for tools used in high-velocity steel machining. It is applied to products that have already been chromed, in order to obtain maximum resistance to wear and tear. In fact, VM, the SuperInox process, increases the surface hardness of the plated product to three times that of traditional chromium plating. Since 2004 Olivari has been using this technology within its exclusive manufacturing facility located in Borgomanero Italy. An additional benefit of the VM process is its ability to offer metallic colours that cannot be produced within the traditional galvanisation process.

VM coating has exceptional performance in stability and longevity of the colour created, making the plated product last and last. If used in accordance with maintenance guidelines, SuperInox finished hardware in Brass, Satin Brass, Bright Nickel, Satin Nickel and Satin Stainless have a **30-year anti tarnish sea air guarantee**. Olivari SuperInox finished hardware in Polished Chrome, Satin Chrome, Satin Copper, Satin Bronze, and Anthracite have a **10-year anti tarnish sea air guarantee**.

## GALVANIC FINISHING

Galvanisation of the brass handle gives it a protective metal coat of nickel-chromium to guard against wear and corrosion.

## CR\_Polished Chrome

The handle is protected by a layer of chrome, forming an excellent barrier against weathering and offering great resistance to wear and tear. The bluish-silver colour and perfect shine make this finish particularly suitable for elegant settings. The finish has a 10-year anti tarnish sea air guarantee.

## SC\_Satin Chrome

The handle is protected by a layer of chrome, forming an excellent barrier against weathering and offering great resistance to wear and tear. The satin finish lends the handle a pleasant tactile quality. The chromed reflections carry a formal connotation suggesting use in modern settings. The finish has a 10-year anti tarnish sea air guarantee.

## EMB\_Electro Matt Black

The handle has a layer of matt black chrome. The satin black finish lends the handle a sophisticated quality. The satin black colour carries a progressive connotation suggesting use in a modern setting. EMB is a finish created with in Australia.

## BRZ\_Dark Bronze Dark (Waxed)

The handle has a layer of chemically treated bronze and wax, forming a living barrier against weathering. The dark rich bronze finish lends the handle a retrospective look and feel. The bronze reflections carry a traditional connotation suggesting use in traditional settings. As a living finish created within Australia, it's bronze colour changes over time and by production batch.

## SUPERINOX FINISHING

With SuperInox, a polished or satin-finish chrome handle is coated with an ulterior layer of metal (superfinishing) under high vacuum. Vacuum metallisation is extremely hard and durable. Nanocomposites of metal determine the specific colour of the surface and protect it from wear, scratches and aggressive substances such as humidity, sweat, salt spray, temperature swings and ultraviolet rays.

## IB\_SuperInox Brass

A practically eternal finish, for its pleasing looks as well as its durability. While the tonality is a prestigious one of rich brass, the qualities of endurance and toughness are the very elevated ones of Olivari SuperInox finishes. The finish has a 30-year anti tarnish sea air guarantee.

## ISB\_SuperInox Satin Brass

This combination between the classical softness of satin brass and the modernity of the SuperInox finish makes for durability and consistency of colour over time. The finish has a 30-year anti tarnish sea air guarantee.

## IBN\_SuperInox Bright Nickel

This shiny finish has a warm, elegant colour of nickel plus the advantages of remaining unaltered over time and not causing allergic reactions. Suitable for comfortable and sophisticated settings. The finish has a 30-year anti tarnish sea air guarantee.

## ISN\_SuperInox Satin Nickel

The satin finish offers full expression to the refined colour of nickel. It exalts and makes more precious the shapes of the handle to which it is applied. The finish has a 30-year anti tarnish sea air guarantee.

## IS\_SuperInox Satin Stainless

The colour is that of stainless steel, but the surface hardness obtained with the VM process is far superior. Its elevated toughness makes this a high-tech finish particularly suited to use on doors in high-traffic locations. The finish has a 30-year anti tarnish sea air guarantee.

## ISC\_SuperInox Satin Copper

This innovative and expressive superfinish represents a taste for strength, character and openness to the new. Suited for refined and sophisticated settings. The finish has a 10-year anti tarnish sea air guarantee.

## ISBRZ\_SuperInox Satin Bronze

This new colour of superfinish is innovative yet timeless. The allure of the past and the memory of its beauty are united with faith in the new and its projection into the future. The finish has a 10-year anti tarnish sea air guarantee.

## IA\_SuperInox Anthracite

This is a dark grey with metallic reflections, making for a very modern and exclusive finish. Its hardness is superior to chrome, and its aesthetics are suited to high-tech settings. The finish has a 10-year anti tarnish sea air guarantee.

*SuperInox finished hardware is guaranteed not to ....*

*Tarnish, Pitt, T Stain or Fade in Sea Air.*

*Not even 316 marine grade Stainless Steel can provide this level of protection.*

*316 is stainless not stainfree.*

**Galvanic finishes**



CR - Polished Chrome



SC - Satin Chrome



EMB - Electro Matt Black



BRZ - Bronze Waxed  
(dark bronze waxed. This is a living finish & will tarnish)

**SuperInox finishes**



IB - SuperInox Brass



ISB - SuperInox Satin Brass



PBU - Polished Brass Unlacquered



PC - Powder Coat

**The Finishes by Olivari of Italy**



IBN - SuperInox Bright Nickel



ISN - SuperInox Satin Nickel



IS - SuperInox Satin Stainless



ISC - SuperInox Satin Copper



ISBRZ - SuperInox Satin Bronze



IA - SuperInox Anthracite

**Finish Guide**

All finishes shown in BLUE come with a 30-year anti tarnish guarantee (30yg)

All finishes shown in GREEN come with a 10-year anti tarnish guarantee (10yg)





**Chevron - M248S**  
Zaha Hadid 2015

Available Finishes:

CR: Polished Chrome  
SC: Satin Chrome

IA: SuperInox Anthracite (10yg)  
ISC: SuperInox Satin Copper (10yg)  
ISBRZ: SuperInox Satin Bronze (10yg)

PBU: Polished Brass Unlacquered  
EMB: Electro Matt Black  
BRZ: Dark Bronze (waxed)  
PC: Powder Coat

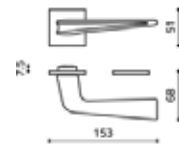

Photographed on 5mm low profile rose. See page 5 for more details.

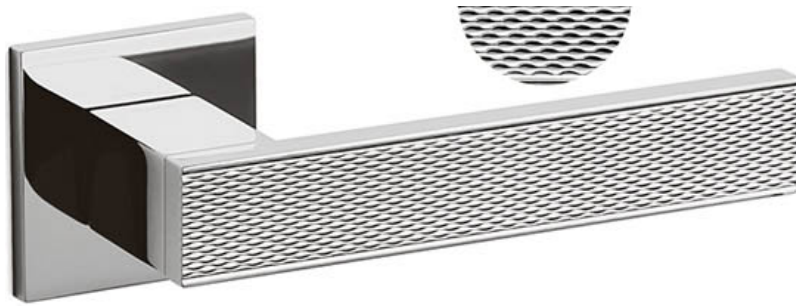

**Diana Barley - M1DBS**  
Studio Olivari 2016

Available Finishes:

CR: Polished Chrome

IB: SuperInox Brass (30yg)  
IBN: SuperInox Bright Nickel (30yg)

EMB: Electro Matt Black

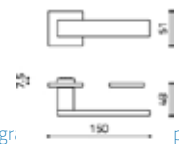

Photographed on 5mm low profile rose. See page 5 for more details.

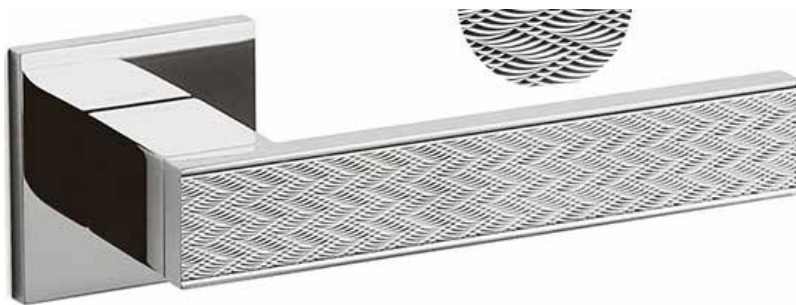

**Diana Chevron - M1DCS**  
Studio Olivari 2016

Available Finishes:

CR: Polished Chrome

IB: SuperInox Brass (30yg)  
IBN: SuperInox Bright Nickel (30yg)

EMB: Electro Matt Black

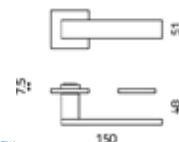

Photographed on 5mm low profile rose. See page 5 for more details.

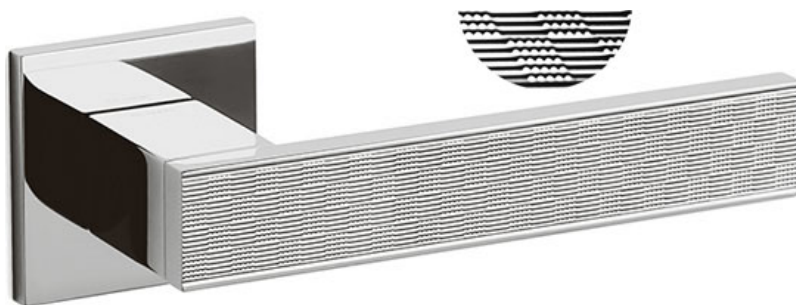

**Diana Damier - M1DDS**  
Studio Olivari 2016

Available Finishes:

CR: Polished Chrome

IB: SuperInox Brass (30yg)  
IBN: SuperInox Bright Nickel (30yg)

EMB: Electro Matt Black

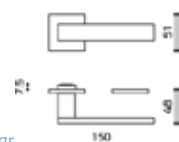

Photographed on 5mm low profile rose. See page 5 for more details.



**Ice Cube - M223S**  
Dominique Perrault 2010

Available Finishes:

CR: Polished Chrome & Super Clear Glass  
SC: Satin Chrome & Super Clear Glass

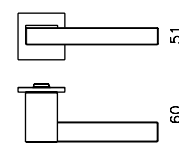

Photographed on 5mm low profile rose. See page 5 for more details.

## Planet Q - M1955

Luca Casini 2006

Available Finishes:

CR: Polished Chrome

IB: SuperInox Brass (30yg)

IS: SuperInox Satin Stainless (30yg)

IBN: SuperInox Bright Nickel (30yg)

ISN: SuperInox Satin Nickel (30yg)

ISB: SuperInox Satin Brass (30yg)

PBU: Polished Brass Unlacquered

EMB: Electro Matt Black

IA: SuperInox Anthracite (10yg)

BRZ: Dark Bronze (waxed)

ISC: SuperInox Satin Copper (10yg)

ISBRZ: SuperInox Satin Bronze (10yg)

Powder Coat

Photographed on 5mm low profile rose. See page 5 for more details.



## Planet Q Bicolour - M1955

Luca Casini 2006

Available Finishes:

CRSC: Polished Chrome & Satin Chrome

IBISB: SuperInox Brass & SuperInox

Photographed on 5mm low profile rose. See page 5 for more details.

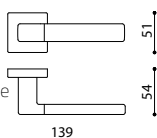

## Minerva - M2055

Franco Sargiani 2006

Available Finishes:

CR: Polished Chrome

IS: SuperInox Satin Stainless (30yg)

PBU: Polished Brass Unlacquered

EMB: Electro Matt Black

BRZ: Dark Bronze (waxed)

Photographed on 5mm low profile rose. See page 5 for more details.

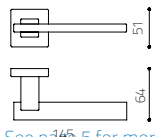

## Diana - M2065

Studio Olivari 2007

Available Finishes:

CR: Polished Chrome

SC: Satin Chrome

IS: SuperInox Satin Stainless (30yg)

IBN: SuperInox Bright Nickel (30yg)

IA: SuperInox Anthracite (10yg)

ISC: SuperInox Satin Copper (10yg)

ISBRZ: SuperInox Satin Bronze (10yg)

PBU: Polished Brass Unlacquered

EMB: Electro Matt Black

BRZ: Dark Bronze (waxed)

Photographed on 5mm low profile rose. See page 5 for more details.

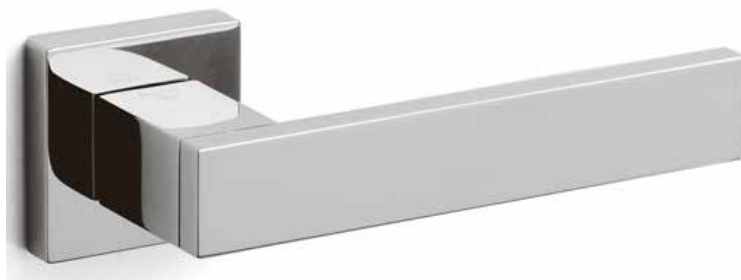
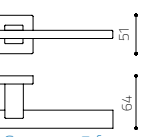

## Blade - M2135

Peter Marino 2008

Available Finishes:

CR: Polished Chrome

SC: Satin Chrome

PBU: Polished Brass Unlacquered

EMB: Electro Matt Black

BRZ: Dark Bronze (waxed)

Photographed on 5mm low profile rose. See page 5 for more details.

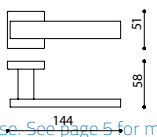



Available on  
Low Rose

**Edge - M212S**  
Peter Marino 2008



CREW - Chrome and Wengé Timber

CREV - Chrome and Oak Wood

IBEN - SuperInox Brass and Black

CREA - Chrome and White Corian

IS6E - SuperInox Satin and Matt Glass

IBEC - SuperInox Brass and Cherry Wood



**Total - M207S**  
Rodolfo Dordoni 2007

Available Finishes:

CR: Polished Chrome

IS: SuperInox Satin Stainless (30yg)

IA: SuperInox Anthracite (10yg)

ISC: SuperInox Satin Copper (10yg)

ISBRZ: SuperInox Satin Bronze (10yg)

PBU: Polished Brass Unlacquered

EMB: Electro Matt Black

BRZ: Dark Bronze (waxed)

PC: Powder Coat

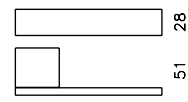

Photographed on 5mm low profile rose. See page 5 for more details.



Available on  
Standard & Low  
Rose

**Lotus Q - M238S**  
Javier Lopez 2014

Available Finishes:

CR: Polished Chrome

IS: SuperInox Satin Stainless (30yg)

ISB: SuperInox Satin Brass (30yg)

IA: SuperInox Anthracite (10yg)

ISC: SuperInox Satin Copper (10yg)

ISBRZ: SuperInox Satin Bronze (10yg)

PBU: Polished Brass Unlacquered

EMB: Electro Matt Black

BRZ: Dark Bronze (waxed)

PC: Powder Coat

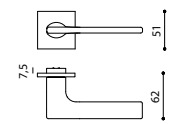

Photographed on 5mm low profile rose. See page 5 for more details.



Available on  
Standard & Low  
Rose

**Living - M222S**  
Dominique Perrault 2010

Available Finishes:

CR: Polished Chrome

IS: SuperInox Satin Stainless (30yg)

IA: SuperInox Anthracite (10yg)

PBU: Polished Brass Unlacquered

EMB: Electro Matt Black

BRZ: Dark Bronze (waxed)

PC: Powder Coat

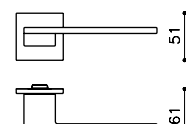

Photographed on 5mm low profile rose. See page 5 for more details.



Available on  
Standard & Low  
Rose

**Trend - M228S**  
Studio Olivari 2012

Available Finishes:

CR: Polished Chrome

SC: Satin Chrome

IS: SuperInox Satin Stainless (30yg)

IA: SuperInox Anthracite (10yg)

ISC: SuperInox Satin Copper (10yg)

PBU: Polished Brass Unlacquered

EMB: Electro Matt Black

BRZ: Dark Bronze (waxed)

PC: Powder Coat

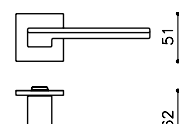

Photographed on 5mm low profile rose. See page 5 for more details.

**Time Q - M1925**  
Alessandro Mendini 2006

Available on  
Standard & Low  
Rose

Available Finishes:

- CRSC: Polished Chrome & Satin Chrome
- CRW: Polished Chrome & Wenge Timber
- SC: Satin Chrome

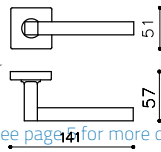

Photographed on 5mm low profile rose. See page 141 for more detail



**Space Q - M1935**  
Alessandro Mendini 2006

Available Finishes:

- CRSC: Polished Chrome & Satin Chrome
- SC: Satin Chrome

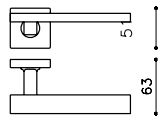

Photographed on 5mm low profile rose. See page 141 for more details.



**Pitagora Q - M2395**  
Giorgetto Giugiaro 2014

Available Finishes:

- CR: Polished Chrome
- CRSC: Polished Chrome/ Satin Chrome

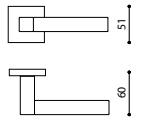

Photographed on 5mm low profile rose. See page 141 for more details.



**Bios - M2045**  
Franco Sargiani 2006

Available Finishes:

- CR: Polished Chrome
- IS: SuperInox Satin Stainless (30yg)
- IA: SuperInox Anthracite (10yg)
- ISBRZ: SuperInox Satin Bronze (10yg)

Available on  
Standard & Low  
Rose

- PBU: Polished Brass Unlacquered
- EMB: Electro Matt Black
- BRZ: Dark Bronze (waxed)
- PC: Powder Coat



Photographed on 5mm low profile rose. See page 141 for more details.



**Euclide Q - M2295**  
Nicola Novelletto 2012

Available Finishes:

- CR: Polished Chrome
- SC: Satin Chrome
- IBN: SuperInox Bright Nickel (30yg)
- IA: SuperInox Anthracite (10yg)
- ISC: SuperInox Satin Copper (10yg)
- ISBRZ: SuperInox Satin Bronze (10yg)

Available on  
Standard & Low  
Rose

- PBU: Polished Brass Unlacquered
- EMB: Electro Matt Black
- BRZ: Dark Bronze (waxed)
- PC: Powder Coat

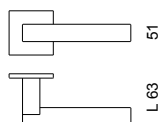

Photographed on 5mm low profile rose. See page 141 for more details.





**Adamant - M216S**  
Patricia Urquiola 2009

Available Finishes:

- CR: Polished Chrome
- SC: Satin Chrome

- PBU: Polished Brass Unlacquered
- EMB: Electro Matt Black
- BRZ: Dark Bronze (waxed)
- PC: Powder Coat

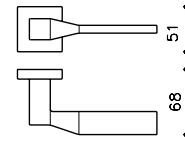

Photographed on 5mm low profile rose. See page 5 for more details.

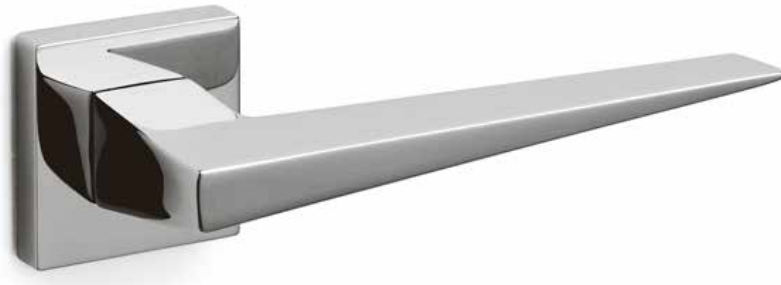

**Denver - M218S**  
Daniel Libeskind 2009

Available Finishes:

- CR: Polished Chrome
- SC: Satin Chrome

- IS: SuperInox Satin Stainless (30yg)

- PBU: Polished Brass Unlacquered
- EMB: Electro Matt Black
- BRZ: Dark Bronze (waxed)
- PC: Powder Coat

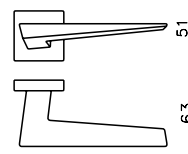

Photographed on 5mm low profile rose. See page 5 for more details.



**Sky - M214S**  
Claudio Bellini 2008

Available Finishes:

- CR: Polished Chrome
- SC: Satin Chrome

- ISBRZ: SuperInox Satin Bronze (10yg)

- PBU: Polished Brass Unlacquered
- EMB: Electro Matt Black
- BRZ: Dark Bronze (waxed)
- PC: Powder Coat

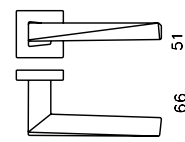

Photographed on 5mm low profile rose. See page 5 for more details.



**Lesmo - M211S**  
Studio Olivari 2008

Available Finishes:

- CR: Polished Chrome
- SC: Satin Chrome

- PBU: Polished Brass Unlacquered
- EMB: Electro Matt Black
- BRZ: Dark Bronze (waxed)
- PC: Powder Coat

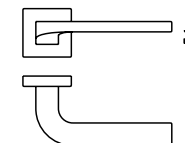

Photographed on 5mm low profile rose. See page 5 for more details.



**Arc - M225S**  
Rodolfo Dordoni 2010

Available on  
Standard & Low  
Rose

Available Finishes:

- CR: Polished Chrome
- SC: Satin Chrome

- PBU: Polished Brass Unlacquered
- EMB: Electro Matt Black
- BRZ: Dark Bronze (waxed)
- PC: Powder Coat

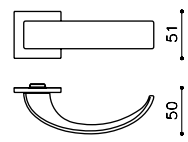

Photographed on 5mm low profile rose. See page 5 for more details.

### Milano Q - M259S

Antonio Citterio 2019

Available Finishes:

CR: Polished Chrome  
SC: Satin Chrome

IS: SuperInox Satin Stainless (30yg)

IA: SuperInox Anthracite (10yg)  
ISBRZ: SuperInox Satin Bronze (10yg)

PBU: Polished Brass Unlacquered

EMB: Electro Matt Black

BRZ: Dark Bronze (waxed)

Photographed on 5mm low profile rose. See page 5 for more details.

Powder Coat



### ABC - M255S

Rem Koolhaas 2019

Available Finishes:

CR: Polished Chrome  
SC: Satin Chrome

IS: SuperInox Satin Stainless (30yg)

IA: SuperInox Anthracite (10yg)  
ISC: SuperInox Satin Copper (10yg)  
ISBRZ: SuperInox Satin Bronze (10yg)

PBU: Polished Brass Unlacquered

EMB: Electro Matt Black

BRZ: Dark Bronze (waxed)

Photographed on 5mm low profile rose. See page 5 for more details.

Powder Coat

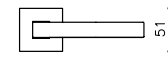

### Icona - M254R

Vincent Van Duysen 2018

Available Finishes:

CR: Polished Chrome  
SC: Satin Chrome

IS: SuperInox Satin Stainless (30yg)

IBN: SuperInox Bright Nickel (30yg)

ISN: SuperInox Satin Nickel (30yg)

IA: SuperInox Anthracite (10yg)

ISC: SuperInox Satin Copper (10yg)

ISBRZ: SuperInox Satin Bronze (10yg)

PBU: Polished Brass Unlacquered

EMB: Electro Matt Black

BRZ: Dark Bronze (waxed)

Photographed on 5mm low profile rose. See page 5 for more details.

Powder Coat

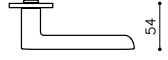
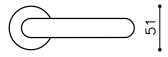

### Plume - M253R

Piero Lissoni 2019

Available Finishes:

CR: Polished Chrome  
SC: Satin Chrome

IS: SuperInox Satin (30yg)

IA: SuperInox Anthracite (10yg)

ISC: SuperInox Satin Copper (10yg)

ISBRZ: SuperInox Satin Bronze (10yg)

PBU: Polished Brass Unlacquered

EMB: Electro Matt Black

BRZ: Dark Bronze (waxed)

Photographed on 5mm low profile rose. See page 5 for more details.

Powder Coat

Available on  
Standard & Low  
Rose



### Vola - M257R

Max Pajetta 2019

Available Finishes:

CR: Polished Chrome  
SC: Satin Chrome

IB: SuperInox Brass (30yg)

ISB: SuperInox Satin Brass (30yg)

IA: SuperInox Anthracite (10yg)

ISC: SuperInox Satin Nickel (10yg)

ISBRZ: SuperInox Satin Bronze (10yg)

PBU: Polished Brass Unlacquered

EMB: Electro Matt Black

BRZ: Dark Bronze (waxed)

Photographed on 5mm low profile rose. See page 5 for more details.

Powder Coat





**Nina - M234R**  
Daniel Libeskind 2012

Available Finishes:

CR: Polished Chrome

IS: SuperInox Satin Stainless (30yg)

IA: SuperInox Anthracite (10yg)

PBU: Polished Brass Unlacquered

EMB: Electro Matt Black

BRZ: Dark Bronze (waxed)

PC: Powder Coat

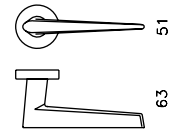

Photographed on 140mm low profile rose. See page 5 for more details.



**Logo - M197R**  
James Irvine 2006

Available Finishes:

CR: Polished Chrome

IS: SuperInox Satin Stainless (30yg)

PBU: Polished Brass Unlacquered

EMB: Electro Matt Black

BRZ: Dark Bronze (waxed)

PC: Powder Coat

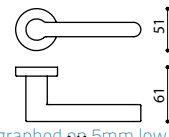

Photographed on 141mm low profile rose. See page 5 for more details.



**Euclide - M229R**  
Nicola Novelletto 2012

Available Finishes:

CR: Polished Chrome

SC: Satin Chrome

IBN: SuperInox Bright Nickel (30yg)

IA: SuperInox Anthracite (10yg)

ISC: SuperInox Satin Copper (10yg)

ISBRZ: SuperInox Satin Bronze (10yg)

PBU: Polished Brass Unlacquered

EMB: Electro Matt Black

BRZ: Dark Bronze (waxed)

PC: Powder Coat

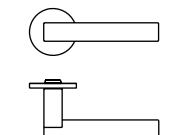

Photographed on 141mm low profile rose. See page 5 for more details.



**Marilyn - M252R**  
Mad Architects 2016

Available Finishes:

CR: Polished Chrome

SC: Satin Chrome

IS: SuperInox Satin Stainless (30yg)

IA: SuperInox Anthracite (10yg)

ISBRZ: SuperInox Satin Bronze (10yg)

PBU: Polished Brass Unlacquered

EMB: Electro Matt Black

BRZ: Dark Bronze (waxed)

PC: Powder Coat

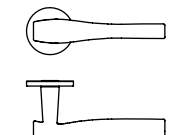

Photographed on 151mm low profile rose. See page 5 for more details.



**Lucy - M231R**  
Patricia Urquiola 2012

Available Finishes:

CR: Polished Chrome

SC: Satin Chrome

IBN: SuperInox Bright Nickel (30yg)

IA: SuperInox Anthracite (10yg)

ISC: SuperInox Satin Copper (10yg)

PBU: Polished Brass Unlacquered

EMB: Electro Matt Black

BRZ: Dark Bronze (waxed)

PC: Powder Coat

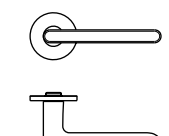

Photographed on 143mm low profile rose. See page 5 for more details.

## Lama - M107R

Gio Ponti 1954

Available Finishes:

CR: Polished Chrome  
IB: SuperInox Brass (30yg)  
IS: SuperInox Satin Stainless (30yg)  
ISB: SuperInox Satin Brass (30yg)

IA: SuperInox Anthracite (10yg)

PBU: Polished Brass Unlacquered

EMB: Electro Matt Black

BRZ: Dark Bronze (waxed)

Photographed on 5mm low profile rose. See page 133 for more details.

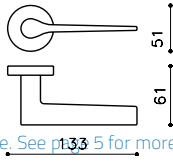

## Lama Large - M106R

Gio Ponti 1954

NEW

Available Finishes:

CR: Polished Chrome  
IS: SuperInox Satin Stainless (30yg)  
ISB: SuperInox Satin Brass (30yg)  
IBN: SuperInox Bright Nickel (30yg)

IA: SuperInox Anthracite (10yg)

ISC: SuperInox Satin Copper (10yg)

ISBRZ: SuperInox Satin Bronze (10yg)

PBU: Polished Brass Unlacquered

EMB: Electro Matt Black

BRZ: Dark Bronze (waxed)

Photographed on 5mm low profile rose. See page 145 for more details.

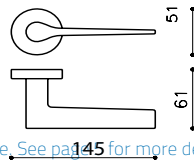

## Lugano - M258R

Carlo Colombo 2019

NEW

Available Finishes:

CR: Polished Chrome  
SC: Satin Chrome  
IS: SuperInox Satin Stainless (30yg)  
ISB: SuperInox Satin Brass (30yg)  
ISN: SuperInox Satin Nickel (30yg)  
IA: SuperInox Anthracite (10yg)  
ISC: SuperInox Satin Copper (10yg)  
ISBRZ: SuperInox Satin Bronze (10yg)

PBU: Polished Brass Unlacquered

EMB: Electro Matt Black

BRZ: Dark Bronze (waxed)

Photographed on 5mm low profile rose. See page 147 for more details.

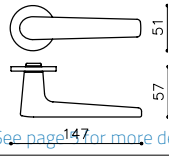

## Diva - M256R

Luca Casini 2019

NEW

Available Finishes:

CR: Polished Chrome  
SC: Satin Chrome

ISB: SuperInox Satin Brass (30yg)

IA: SuperInox Anthracite (10yg)

ISBRZ: SuperInox Satin Bronze (10yg)

PBU: Polished Brass Unlacquered

EMB: Electro Matt Black

BRZ: Dark Bronze (waxed)

Photographed on 5mm low profile rose. See page 146 for more details.

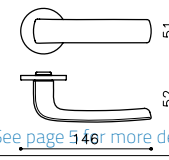

## Lotus - M238R

Javier Lopez 2014

Available Finishes:

CR: Polished Chrome  
IS: SuperInox Satin Stainless (30yg)  
ISB: SuperInox Satin Brass (30yg)  
IBN: SuperInox Bright Nickel (30yg)  
ISN: SuperInox Satin Nickel (30yg)  
IA: SuperInox Anthracite (10yg)  
ISC: SuperInox Satin Copper (10yg)  
ISBRZ: SuperInox Satin Bronze (10yg)

PBU: Polished Brass Unlacquered

EMB: Electro Matt Black

Photographed on 5mm low profile rose. See page 145 for more details.

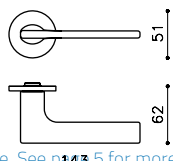





**Ala - M215R**  
Massimo Iosa Ghini 2009

Available Finishes:

CR: Polished Chrome  
SC: Satin Chrome

PBU: Polished Brass Unlacquered  
EMB: Electro Matt Black  
BRZ: Dark Bronze (waxed)  
PC: Powder Coat

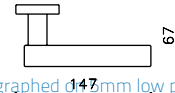

Photographed on 147mm low profile rose. See page 5 for more details.



**Fin - M217R**  
Toyo Ito 2009

Available Finishes:

CR: Polished Chrome  
SC: Satin Chrome

IBN: SuperInox Bright Nickel (30yg)  
ISN: SuperInox Satin Nickel (30yg)

EMB: Electro Matt Black  
BRZ: Dark Bronze (waxed)  
PC: Powder Coat



Photographed on 142mm low profile rose. See page 5 for more details.



**Selene - M194R**  
Massimo Iosa Ghini 2005

Available on  
Standard & Low  
Rose

Available Finishes:

CRSC: Polished Chrome & Satin Chrome  
SC: Satin Chrome

IBISB: SuperInox Brass & SuperInox  
Rose. See page 5 for more details.

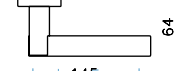
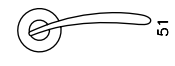

Photographed on 145mm low profile rose. See page 5 for more details.



**Laser - M176R**  
Richard Sapper 1998

Available on  
Standard & Low  
Rose

Available Finishes:

CR: Polished Chrome  
SC: Satin Chrome

IS: SuperInox Satin Stainless (30yg)

IA: SuperInox Anthracite (10yg)

PBU: Polished Brass Unlacquered  
EMB: Electro Matt Black  
BRZ: Dark Bronze (waxed)  
PC: Powder Coat

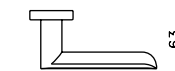
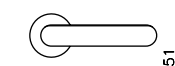

Photographed on 138mm low profile rose. See page 5 for more details.



**Madison - M196R**  
Luca Casini 2005

Available Finishes:

CR: Polished Chrome  
SC: Satin Chrome

PBU: Polished Brass Unlacquered  
EMB: Electro Matt Black  
BRZ: Dark Bronze (waxed)  
PC: Powder Coat

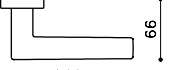

Photographed on 144mm low profile rose. See page 5 for more details.

### Radial - M235R

Rodolfo Dordoni 2014

Available Finishes:

CR: Polished Chrome

IS: SuperInox Satin Stainless (30yg)

IA: SuperInox Anthracite (10yg)

ISC: SuperInox Satin Copper (10yg)

ISBRZ: SuperInox Satin Bronze (10yg)

PBU: Polished Brass Unlacquered

EMB: Electro Matt Black

BRZ: Dark Bronze (waxed)

PC: Powder Coat

Photographed on 5mm low profile rose. See page 157 for more details.

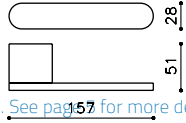

### Link - M200R

Piero Lissoni 2006

Available Finishes:

CR: Polished Chrome

IS: SuperInox Satin Stainless (30yg)

IBN: SuperInox Bright Nickel (30yg)

ISB: SuperInox Satin Brass (30yg)

IA: SuperInox Anthracite (10yg)

ISC: SuperInox Satin Copper (10yg)

ISN: SuperInox Satin Nickel (10yg)

ISBRZ: SuperInox Satin Bronze (10yg)

PBU: Polished Brass Unlacquered

EMB: Electro Matt Black

BRZ: Dark Bronze (waxed)

PC: Powder Coat

Photographed on 5mm low profile rose. See page 142 for more details.

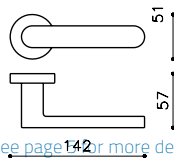

### Planet - M195R

Luca Casini 2005

Available Finishes:

CR: Polished Chrome

IB: SuperInox Brass (30yg)

IS: SuperInox Satin Stainless (30yg)

IBN: SuperInox Bright Nickel (30yg)

ISN: SuperInox Satin Nickel (30yg)

ISB: SuperInox Satin Brass (30yg)

IA: SuperInox Anthracite (10yg)

ISC: SuperInox Satin Copper (10yg)

ISBRZ: SuperInox Satin Bronze (10yg)

PBU: Polished Brass Unlacquered

EMB: Electro Matt Black

BRZ: Dark Bronze (waxed)

PC: Powder Coat

Photographed on 5mm low profile rose. See page 139 for more details.

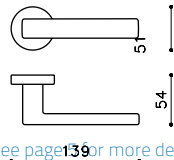

### Planet Bicolour - M195R

Luca Casini 2005

Available Finishes:

CRSC: Polished Chrome & Satin Chrome

IBISB: SuperInox Brass & SuperInox Satin Brass (30yg)

Photographed on 5mm low profile rose. See page 139 for more details.

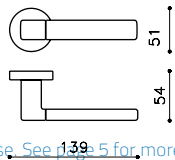

### Beta - M221R

Joe Colombo 2010

Available Finishes:

CR: Polished Chrome

SC: Satin Chrome

IS: SuperInox Satin Stainless (30yg)

IA: SuperInox Anthracite (10yg)

PBU: Polished Brass Unlacquered

EMB: Electro Matt Black

BRZ: Dark Bronze (waxed)

PC: Powder Coat

Photographed on 5mm low profile rose. See page 145 for more details.

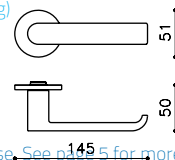

**Atena Rank - M1ARR**  
Studio Olivari 2016



Available on Standard & Low Rose

Available Finishes:

- CR: Polished Chrome
- IB: SuperInox Brass (30yg)
- IBN: SuperInox Bright Nickel (30yg)

EMB: Electro Matt Black  
Profile rose. See page 5 for more details.

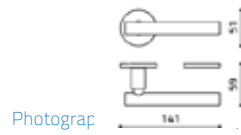

Photograph

**Atena Ligne - M1ALR**  
Studio Olivari 2016



Available on Standard & Low Rose

Available Finishes:

- CR: Polished Chrome
- IB: SuperInox Brass (30yg)
- IBN: SuperInox Bright Nickel (30yg)

EMB: Electro Matt Black  
Profile rose. See page 5 for more details.

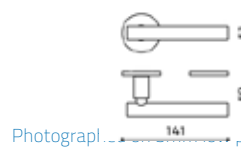

Photograph

**Atena Panier - M1APR**  
Studio Olivari 2016



Available on Standard & Low Rose

Available Finishes:

- CR: Polished Chrome
- IB: SuperInox Brass (30yg)
- IBN: SuperInox Bright Nickel (30yg)

EMB: Electro Matt Black  
Profile rose. See page 5 for more details.

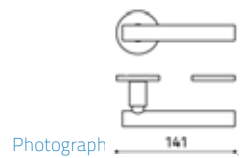

Photograph

**Dolce Vita - M243R**  
Marcel Wanders 2014



Available on Standard & Low Rose

Available Finishes:

- CR: Polished Chrome
- SC: Satin Chrome
- IB: SuperInox Brass (30yg)
- IBN: SuperInox Bright Nickel (30yg)
- IA: SuperInox Anthracite (10yg)
- ISBRZ: SuperInox Satin Bronze (10yg)

PBU: Polished Brass Unlacquered  
EMB: Electro Matt Black  
BRZ: Dark Bronze (waxed)  
PC: Powder Coat

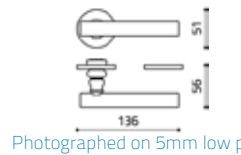

Photographed on 5mm low profile rose. See page 5 for more details.

**Pitagora - M239R**  
Giorgetto Giugiaro 2014



Available on Standard & Low Rose

Available Finishes:

- CR: Polished Chrome
- CRSC: Polished Chrome & Satin Chrome
- IS: SuperInox Satin Stainless (30yg)

Photographed on 5mm low profile rose. See page 5 for more details.

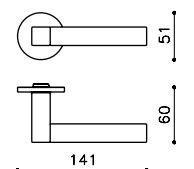

**Time - M192R**  
Alessandro Mendini 2004

Available Finishes:

- CRSC: Polished Chrome & Satin Chrome
- CRWT: Chrome & Wenge Timber
- SC: Satin Chrome

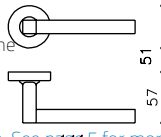

IS: SuperInox Satin Stainless (30yg)  
Photographed on 5mm low profile rose. See page 141 5 for more details.



**Space - M193R**  
Alessandro Mendini 2004

Available Finishes:

- CRSC: Polished Chrome & Satin Chrome
- SC: Satin Chrome

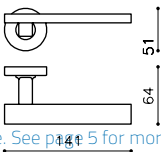

IS: SuperInox Satin Stainless (30yg)  
Photographed on 5mm low profile rose. See page 141 5 for more details.



**Alexandra - M150R**  
F. A. Porsche 1989

Available Finishes:

- CR: Polished Chrome

IS: SuperInox Satin Stainless (30yg)

- PBU: Polished Brass Unlacquered
- EMB: Electro Matt Black
- BRZ: Dark Bronze (waxed)

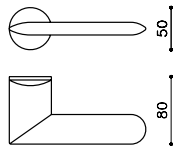

Photographed on 5mm low profile rose. See page 162 for more details.



**Open - M249R**  
Rem Koolhaas 2015

Available Finishes:

- CR: Polished Chrome
- CRSC: Polished Chrome & Satin Chrome

IS: SuperInox Satin Stainless (30yg)

- IA: SuperInox Anthracite (10yg)
- ISC: SuperInox Satin Copper (10yg)
- ISBRZ: SuperInox Satin Bronze (10yg)

- PBU: Polished Brass Unlacquered
- EMB: Electro Matt Black
- BRZ: Dark Bronze (waxed)

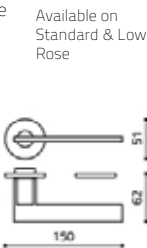

Photographed on 5mm low profile rose. See page 150 for more details.

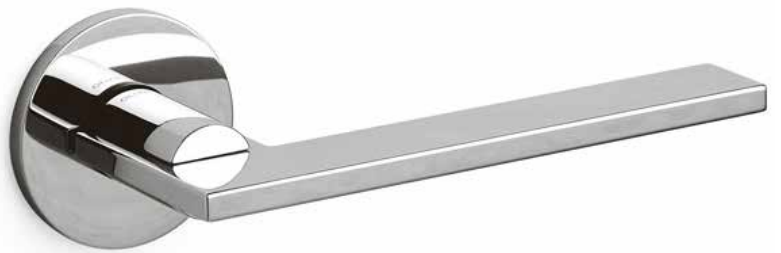

**Virgola - M251R**  
Ron Gilad 2016

Available Finishes:

- CR: Polished Chrome
- SC: Satin Chrome

IS: SuperInox Satin Stainless (30yg)

IA: SuperInox Anthracite (10yg)

- PBU: Polished Brass Unlacquered
- EMB: Electro Matt Black
- BRZ: Dark Bronze (waxed)

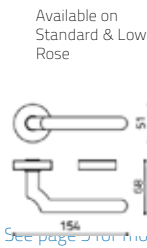

Photographed on 5mm low profile rose. See page 154 for more details.





**Stilo - M190R**  
Enzo Mari 2003

Available Finishes:

- CR: Polished Chrome
- IB: SuperInox Brass (30yg)
- IS: SuperInox Satin Stainless (30yg)

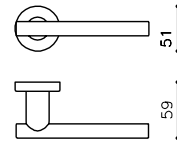

Photographed on 5mm low profile rose. See page 5 for more details.  
PBU: Polished Brass Unlacquered  
EMB: Electro Matt Black  
BRZ: Dark Bronze (waxed)  
PC: Powder Coat



**Beijing - M208R**  
Steven Holl 2008

Available Finishes:

- CR: Polished Chrome
- SC: Satin Chrome
- IS: SuperInox Satin Stainless (30yg)
- IS: SuperInox Satin Stainless (30yg)
- IA: SuperInox Anthracite (10yg)

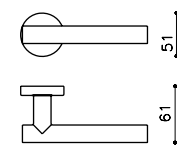

Photographed on 5mm low profile rose. See page 5 for more details.  
PBU: Polished Brass Unlacquered  
EMB: Electro Matt Black  
BRZ: Dark Bronze (waxed)  
PC: Powder Coat



**Sibilla - M154R**  
Vico Magristeretti 1992

Available Finishes:

- CR: Polished Chrome
- SC: Satin Chrome
- PBU: Polished Brass Unlacquered
- EMB: Electro Matt Black
- BRZ: Dark Bronze (waxed)

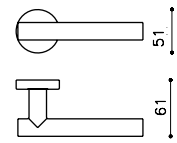

Photographed on 5mm low profile rose. See page 5 for more details.  
PC: Powder Coat



**Serenella - M130R**  
Studio Olivari 2009

Available Finishes:

- CR: Polished Chrome
- SC: Satin Chrome
- IS: SuperInox Satin Stainless (30yg)
- IA: SuperInox Anthracite (10yg)

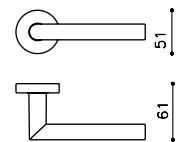

Photographed on 5mm low profile rose. See page 5 for more details.  
PBU: Polished Brass Unlacquered  
EMB: Electro Matt Black  
BRZ: Dark Bronze (waxed)  
PC: Powder Coat



**Raffaella - M128R**  
Studio Olivari 1975

Available Finishes:

- CR: Polished Chrome
- SC: Satin Chrome
- IB: SuperInox Brass (30yg)
- IS: SuperInox Satin Stainless (30yg)
- ISB: SuperInox Satin Brass (30yg)
- IA: SuperInox Anthracite (10yg)
- ISC: SuperInox Satin Copper (10yg)
- ISBRZ: SuperInox Satin Bronze (10yg)
- PBU: Polished Brass Unlacquered
- EMB: Electro Matt Black
- BRZ: Dark Bronze (waxed)
- PC: Powder Coat

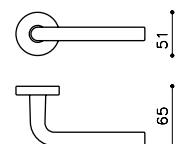

Photographed on 5mm low profile rose. See page 5 for more details.

## Tizianella F - M112R

Sergio Asti 1962

Available Finishes:

CR: Polished Chrome  
SC: Satin Chrome

IB: SuperInox Brass (30yg)  
IS: SuperInox Satin Stainless (30yg)  
ISB: SuperInox Satin Brass (30yg)

PBU: Polished Brass Unlacquered  
EMB: Electro Matt Black  
BRZ: Dark Bronze (waxed)

Photographed on 5mm low profile rose. See page 5 for more details.  
Powder Coat

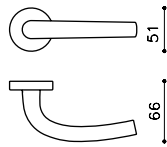

## Garda - M105R

Ignazio Gardella 1951

Available Finishes:

CR: Polished Chrome  
SC: Satin Chrome

IB: SuperInox Brass (30yg)

ISBRZ: SuperInox Satin Bronze (10yg)

PBU: Polished Brass Unlacquered  
EMB: Electro Matt Black  
BRZ: Dark Bronze (waxed)

Photographed on 5mm low profile rose. See page 5 for more details.  
Powder Coat

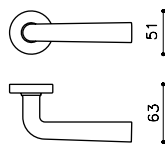

## Sector - M186R

Studio Olivari 2002

Available Finishes:

CRSC: Polished Chrome &  
Satin Chrome

IBISB: SuperInox Brass &  
Satin Brass (30yg)

Photographed on 5mm low profile rose. See page 5 for more details.  
Powder Coat

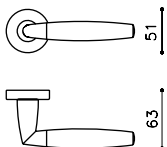

## Aurelia - M185R

Studio Olivari 2002

Available Finishes:

CR: Polished Chrome  
SC: Satin Chrome

IB: SuperInox Brass (30yg)  
IS: SuperInox Satin Stainless (30yg)  
IBN: SuperInox Bright Nickel (30yg)  
ISN: SuperInox Satin Nickel (30yg)  
ISB: SuperInox Satin Brass (30yg)

IA: SuperInox Anthracite (10yg)  
ISC: SuperInox Satin Copper (10yg)

ISBRZ: SuperInox Satin Bronze (10yg)

PBU: Polished Brass Unlacquered  
EMB: Electro Matt Black

BRZ: Dark Bronze (waxed)

Photographed on 5mm low profile rose. See page 5 for more details.  
Powder Coat

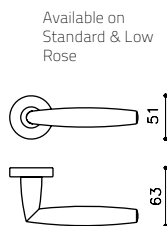

## Moon - M226R

Shigeru Ban 2010

Available Finishes:

CR: Polished Chrome

IS: SuperInox Satin Stainless (30yg)

PBU: Polished Brass Unlacquered

EMB: Electro Matt Black

BRZ: Dark Bronze (waxed)

Photographed on 5mm low profile rose. See page 5 for more details.  
Powder Coat

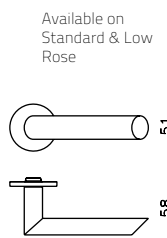

**Crystal Royal - M245R**  
Marcel Wanders 2015



Available on  
Standard & Low  
Rose



Available Finishes:

CR: Polished Chrome & Crystal  
SC: Satin Chrome & Crystal

IB: SuperInox Brass & Crystal (30yg)

Photographed on 5mm low profile rose. See page 5 for more details.

**Crystal Diamond - M246R**  
Marcel Wanders 2015



Available on  
Standard & Low  
Rose



Available Finishes:

CR: Polished Chrome & Crystal  
SC: Satin Chrome & Crystal

IB: SuperInox Brass & Crystal (30yg)

Photographed on 5mm low profile rose. See page 5 for more details.

**Aurora - M164R**  
Alessandro Mendini 1994



Available on  
Standard & Low  
Rose

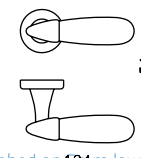

Available Finishes:

CR: Polished Chrome & C1, C5, C6 glass  
SC: Satin Chrome & 6M glass

IB: Polished Chrome & C1, C5, C6 glass

Choice of glass colour includes: (C1) Light Blue, (C5) Amber, (C6) Transparent, (6M) Matt Transparent

Photographed on 5mm low profile rose. See page 5 for more details.

**Conca - M236R**  
Patricia Urquiola 2014

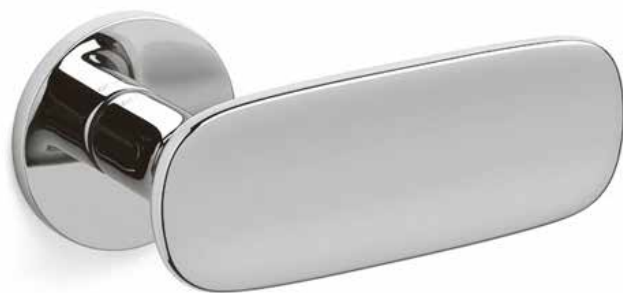

Available on  
Standard & Low  
Rose

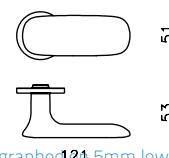

Available Finishes:

CR: Polished Chrome  
SC: Satin Chrome

IS: SuperInox Satin Stainless (30yg)

IA: SuperInox Anthracite (10yg)  
ISC: SuperInox Satin Copper (10yg)  
ISBRZ: SuperInox Satin Bronze (10yg)

PBU: Polished Brass Unlacquered  
EMB: Electro Matt Black  
BRZ: Dark Bronze (waxed)

Photographed on 5mm low profile rose. See page 5 for more details.

**Marbella - M237R**  
Studio Olivari 2014



Available on  
Standard & Low  
Rose

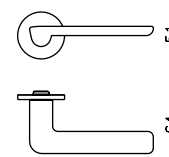

Available Finishes:

CR: Polished Chrome

IS: SuperInox Satin Stainless (30yg)

ISBRZ: SuperInox Satin Bronze (10yg)

PBU: Polished Brass Unlacquered  
EMB: Electro Matt Black  
BRZ: Dark Bronze (waxed)

Photographed on 5mm low profile rose. See page 5 for more details.

## Chelsea - M232R

Jean Nouvel 2013

Available Finishes:

CRB: Polished Chrome with  
Matt Black Porcelain

CRW: Polished Chrome with  
White Porcelain

SCB: Satin Chrome with Matt Black  
Porcelain

SCW: Satin Chrome with White  
Porcelain

Photograph on 5mm low profile rose. See page 5 for more details.



## Twist - M242R1

Ben Van Berkel 2014

Available Finishes:

CR: Polished Chrome

SC: Satin Chrome

IS: SuperInox Satin Stainless (30yg)

IBN: SuperInox Bright Nickel (30yg)

IA: SuperInox Anthracite (10yg)

ISC: SuperInox Satin Copper (10yg)

PBU: Polished Brass Unlacquered

EMB: Electro Matt Black

BRZ: Dark Bronze (waxed)

Powder Coat

Photograph on 5mm low profile rose. See page 5 for more details.

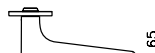
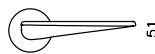

## Globe - M227R

Stefano Giovannoni 2012

Available Finishes:

CR: Polished Chrome

SC: Satin Chrome

ISN: SuperInox Satin Nickel (30yg)

PBU: Polished Brass Unlacquered

EMB: Electro Matt Black

BRZ: Dark Bronze (waxed)

Powder Coat

Photograph on 5mm low profile rose. See page 5 for more details.

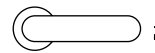

## Tecno - M182R

Giorgetto Giugiaro 1999

Available Finishes:

CR: Polished Chrome

SC: Satin Chrome

IB: SuperInox Brass (30yg)

IS: SuperInox Satin Stainless (30yg)

ISB: SuperInox Satin Brass (30yg)

ISN: SuperInox Satin Nickel (30yg)

ISBRZ: SuperInox Satin Bronze (10yg)

PBU: Polished Brass Unlacquered

EMB: Electro Matt Black

BRZ: Dark Bronze (waxed)

Powder Coat

Photograph on 5mm low profile rose. See page 5 for more details.

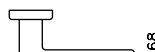
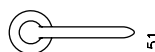

## Futura - M172R

Studio Olivari 1997

Available Finishes:

CR: Polished Chrome

IB: SuperInox Brass (30yg)

IS: SuperInox Satin Stainless (30yg)

ISN: SuperInox Satin Nickel (30yg)

PBU: Polished Brass Unlacquered

EMB: Electro Matt Black

BRZ: Dark Bronze (waxed)

Powder Coat

Photograph on 5mm low profile rose. See page 5 for more details.

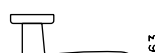





**Aster - M174R**  
Studio Olivari 1998

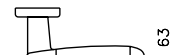

Photographed 136mm low profile rose. See page 5 for more details.

Available Finishes:

CRSC: Polished Chrome & Satin Chrome  
CRE: Polished Chrome & Black Acrylic

IBISB: SuperInox Brass & SuperInox  
See page 5 for more details.



**Comet - M183R**  
Nicola Novelletto 2001



Photographed 144mm low profile rose. See page 5 for more details.

Available Finishes:

CRSC: Polished Chrome & Satin Chrome  
CRIN: Polished Chrome & SuperInox  
Satin Nickel

IBISB: SuperInox Brass & SuperInox  
See page 5 for more details.



**Club - M181R**  
Vico Magistretti 1999



Photographed 143mm low profile rose. See page 5 for more details.

Available Finishes:

CRXX: Polished Chrome & leather

Leather colours: (XN) Black, (XF) Dark Brown, (XE) Brown or (XB) Ivory



**Flaminia - M159R**  
Studio Olivari 1994



Photographed 135mm low profile rose. See page 5 for more details.

Available Finishes:

CR: Polished Chrome  
SC: Satin Chrome

IB: SuperInox Brass (30yg)  
ISB: SuperInox Satin Brass (30yg)

ISBRZ: SuperInox Satin Bronze (10yg)

PBU: Polished Brass Unlacquered  
EMB: Electro Matt Black

BRZ: Dark Bronze (waxed)  
PC: Powder Coat



**Emilia - M167R**  
Studio Olivari 1996

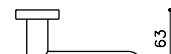
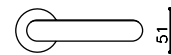

Photographed 138mm low profile rose. See page 5 for more details.

Available Finishes:

CR: Polished Chrome  
SC: Satin Chrome

IB: SuperInox Brass (30yg)  
ISB: SuperInox Satin Brass (30yg)

ISBRZ: SuperInox Satin Bronze (10yg)

PBU: Polished Brass Unlacquered  
EMB: Electro Matt Black

BRZ: Dark Bronze (waxed)  
PC: Powder Coat

**Golia - M160R**  
Studio Olivari 1994

Available Finishes:

CR: Polished Chrome  
SC: Satin Chrome

IB: SuperInox Brass (30yg)

ISBRZ: SuperInox Satin Bronze (10yg)

PBU: Polished Brass Unlacquered

EMB: Electro Matt Black

BRZ: Dark Bronze (waxed)

PC: Powder Coat

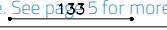

**Polo - M152R**  
Rodolfo Bonetto 1991

Available Finishes:

CR: Polished Chrome  
SC: Satin Chrome

PBU: Polished Brass Unlacquered

EMB: Electro Matt Black

BRZ: Dark Bronze (waxed)

PC: Powder Coat

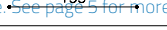
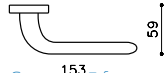
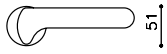

**Bond - M163R**  
Andrea Branzi 1994

Available Finishes:

SC: Satin Chrome

IB: SuperInox Brass (30yg)

PBU: Polished Brass Unlacquered

EMB: Electro Matt Black

BRZ: Dark Bronze (waxed)

PC: Powder Coat



**Novella - M165R**  
Roberto Volonterio & Nicola Novelletto 1996

Available Finishes:

CR: Polished Chrome

IB: SuperInox Brass (30yg)

IS: SuperInox Satin Stainless (30yg)

ISB: SuperInox Satin Brass (30yg)

ISBRZ: SuperInox Satin Bronze (10yg)

PBU: Polished Brass Unlacquered

EMB: Electro Matt Black

BRZ: Dark Bronze (waxed)

PC: Powder Coat

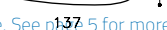
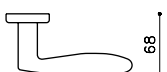

**Agata - M116R**  
Franco Albini & France Helg 1965

Available Finishes:

CR: Polished Chrome  
SC: Satin Chrome

IB: SuperInox Brass (30yg)

PBU: Polished Brass Unlacquered

EMB: Electro Matt Black

BRZ: Dark Bronze (waxed)

PC: Powder Coat





**Wind - M187R**  
Studio Olivari 2003

Available Finishes:

CR: Polished Chrome  
SC: Satin Chrome

IB: SuperInox Brass (30yg)  
ISB: SuperInox Satin Brass (30yg)

PBU: Polished Brass Unlacquered  
EMB: Electro Matt Black  
BRZ: Dark Bronze (waxed)

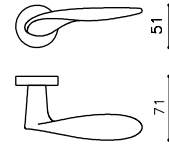

Photographed on 140mm low profile rose. See page 5 for more details.



**Onda - M175R**  
Nicola Novelletto 1998

Available Finishes:

CR: Polished Chrome

IB: SuperInox Brass (30yg)  
IS: SuperInox Satin Stainless (30yg)  
IBN: SuperInox Bright Nickel (30yg)  
ISB: SuperInox Satin Brass (30yg)

ISC: SuperInox Satin Copper (10yg)  
ISBRZ: SuperInox Satin Bronze (10yg)

PBU: Polished Brass Unlacquered  
EMB: Electro Matt Black  
BRZ: Dark Bronze (waxed)



Photographed on 143mm low profile rose. See page 5 for more details.



**Nirvana - M173R**  
Massimo Iosa Ghini 1997

Available on  
Standard & Low  
Rose

Available Finishes:

CR: Polished Chrome  
SC: Satin Chrome

IB: SuperInox Brass (30yg)

PBU: Polished Brass Unlacquered  
EMB: Electro Matt Black  
BRZ: Dark Bronze (waxed)



Photographed on 144mm low profile rose. See page 5 for more details.



**Chiara - M125R**  
Studio Olivari 1975

DDA Compliant Version Available

Available Finishes:

CR: Polished Chrome  
SC: Satin Chrome

PBU: Polished Brass Unlacquered  
EMB: Electro Matt Black  
BRZ: Dark Bronze (waxed)

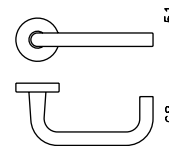

Photographed on 145mm low profile rose. See page 5 for more details.



**Clinica 140 - M114R**  
Studio Olivari 1965

Available Finishes:

SC: Satin Chrome

PBU: Polished Brass Unlacquered  
EMB: Electro Matt Black  
BRZ: Dark Bronze (waxed)

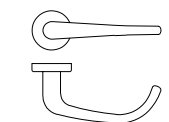

Photographed on 154mm low profile rose. See page 5 for more details.

**Icaro - M168R**  
Paolo Portoghesi 1997

Available Finishes:

IB: [SuperInox Brass \(30yg\)](#)

PBU: Polished Brass Unlacquered

EMB: Electro Matt Black

BRZ: Dark Bronze (waxed)

PC: Powder Coat  
Photographed on 5mm low profile rose. See page 5 for more details.



**Siena - M169R**  
Novelletto, Volonterio 1997

Available Finishes:

CR: Polished Chrome

SC: Satin Chrome

IB: [SuperInox Brass \(30yg\)](#)

ISB: [SuperInox Satin Brass \(30yg\)](#)

ISBRZ: [SuperInox Satin Bronze \(10yg\)](#)

PBU: Polished Brass Unlacquered

EMB: Electro Matt Black

BRZ: Dark Bronze (waxed)

PC: Powder Coat  
Photographed on 5mm low profile rose. See page 5 for more details.

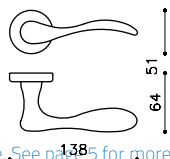

**Orvieto - M170R**  
Novelletto, Volonterio 1997

Available Finishes:

CR: Polished Chrome

SC: Satin Chrome

IB: [SuperInox Brass \(30yg\)](#)

ISB: [SuperInox Satin Brass \(30yg\)](#)

ISBRZ: [SuperInox Satin Bronze \(10yg\)](#)

PBU: Polished Brass Unlacquered

EMB: Electro Matt Black

BRZ: Dark Bronze (waxed)

PC: Powder Coat  
Photographed on 5mm low profile rose. See page 5 for more details.

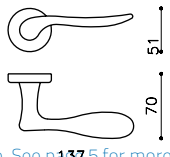

**Uovo - M108R**  
Studio Olivari 1957

Available Finishes:

CR: Polished Chrome

SC: Satin Chrome

IB: [SuperInox Brass \(30yg\)](#)

ISB: [SuperInox Satin Brass \(30yg\)](#)

ISBRZ: [SuperInox Satin Bronze \(10yg\)](#)

PBU: Polished Brass Unlacquered

EMB: Electro Matt Black

BRZ: Dark Bronze (waxed)

PC: Powder Coat  
Photographed on 5mm low profile rose. See page 5 for more details.

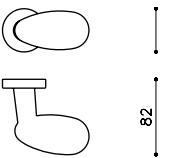

**Blindo - M178R**  
Penta Associati 1998

Available Finishes:

CR: Polished Chrome

SC: Satin Chrome

IB: [SuperInox Brass \(30yg\)](#)

IS: [SuperInox Satin Stainless \(30yg\)](#)

IBN: [SuperInox Bright Nickel \(30yg\)](#)

ISB: [SuperInox Satin Brass \(30yg\)](#)

ISN: [SuperInox Satin Nickel \(30yg\)](#)

IA: [SuperInox Anthracite \(10yg\)](#)

ISC: [SuperInox Satin Copper \(10yg\)](#)

ISBRZ: [SuperInox Satin Bronze \(10yg\)](#)

PBU: Polished Brass Unlacquered

EMB: Electro Matt Black

BRZ: Dark Bronze (waxed)

PC: Powder Coat  
Photographed on 5mm low profile rose. See page 5 for more details.

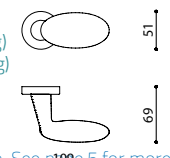

**Boma (Nylon) - M501R**  
GPA Monti 1972

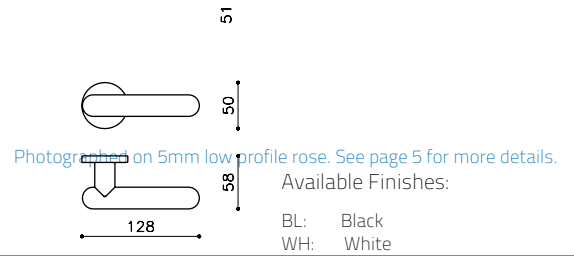

**Iseo (Nylon) - M507R**  
Sergio Asti 1983

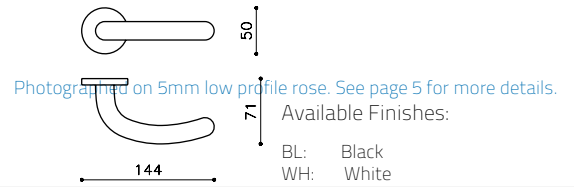

**Chiara (Nylon) - M509R**  
Studio Olivari 1975

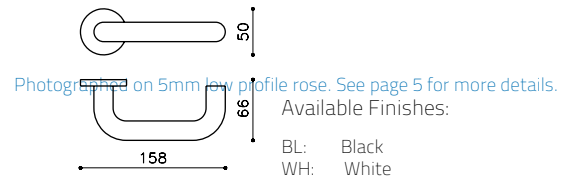

Available on  
Standard & Low  
Rose

Photographed on 5mm low profile rose. See page 5 for more details.

Available on  
Standard & Low  
Rose

Photographed on 5mm low profile rose. See page 5 for more details.

L122 | Planet Q Studio Olivari  
L121



Specification Code  
L121F - Fixed  
L121T - 3PT  
L121TE-3PT E  
cylinder hole

Specification Code  
L122F - Fixed  
L122T - 3PT  
L122TE-3PT E  
cylinder hole

Available Finishes:  
CR, SC  
IB, IS, ISB, IBN, ISN  
IA, ISC, ISBRZ  
PBU, EMB, PC, BRZ

L123 | Planet Q Short Studio Olivari  
L124



Available Finish

CR: Chrome  
SC: Satin Chrom

IB: SuperInox Brass (30yw)  
IS: SuperInox Satin (30yw)  
INB: SuperInox Nickel Bright (30yw)  
ISB: SuperInox Satin Brass (30yw)  
IA: SuperInox Anthracite (10yw)  
ISC: SuperInox Satin Coper (10yw)  
ISBRZ: SuperInox Satin Bronze (10yw)

PBU: Polished Brass Unlaquered  
EMB: Electr Matt Black  
BRZ: Dark Wax Bronze  
PC: Powder Coat Colour

Available Finishes:  
CR, SC  
IB, IS, ISN  
IA, ISC, ISBRZ  
PBU, EMB, PC, BRZ

L221 | Lotus Q Javier Lopez  
L222

New Fixed Sliding Pull / Flush Pull Handle (F)

- Back to Back Long Pull - Fixed
- Back to Back Long Pull Flush Pull
- With or Without Euro Cylinder Hole Cut Out

New 3-Point Turn System for European Locks (T)

- Back to Back Long Pull - Fixed
- Back to Back Long Pull Flush Pull
- With or Without Euro Cylinder Hole Cut Out

F= Fixed Back to Back

T = Back to Back 3pt turn

TE = Back to Back with Euro Cylinder Hole

Available Finish

CR: Chrome  
SC: Satin Chrome

IB: SuperInox Brass (30yw)  
IS: SuperInox Satin Stainless (30yw)  
INB: SuperInox Nickel Bright (30yw)  
ISB: SuperInox Satin Brass (30yw)

IA: SuperInox Anthracite (10yw)  
ISC: SuperInox Satin Coper (10yw)  
ISBRZ: SuperInox Satin Bronze (10yw)

PBU: Polished Brass Unlaquered  
EMB: Electr Matt Black  
BRZ: Dark Wax Bronze  
PC: Powder Coat Colour

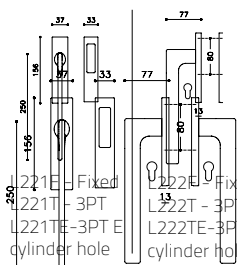

Available Finish

CR: Chrome  
SC: Satin Chro

IB: SuperInox  
IS: SuperInox  
INB: SuperInox  
ISB: SuperInox

IA: SuperInox  
ISC: SuperInox  
ISBRZ: SuperInox

Available Finishes:

CR, SC: Polished E  
IB, IS, INB, ISN: Electr Mat  
IA, ISBRZ, BRZ: Dark Wax  
PBU, EMB, PC, BRZ: Powder Co



L211 | Lotus Javier Lopez  
L212

L136 | Lama Gio Ponti  
L137



**NEW**



**NEW**

**NEW**

Available Finishes:  
CR, SC  
IB, IS, IBN, ISN  
IA, ISC, ISBRZ  
PBU, EMB, PC, BRZ

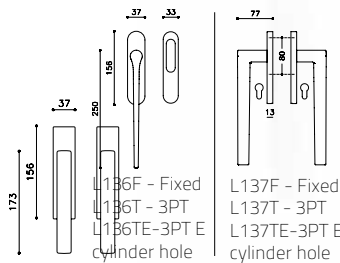
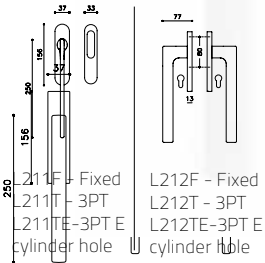

Available Finishes:  
CR, SC  
IB, IS, IBN  
IA, ISC, ISBRZ  
PBU, EMB, PC, BRZ

L131 | Beta Jo Colombo  
L132 | Planet Q SCRto Studio Olivari

L126 | Link Piero Lissoni  
L127 | Planet Q SCRto Studio Olivari



**NEW**



**NEW**

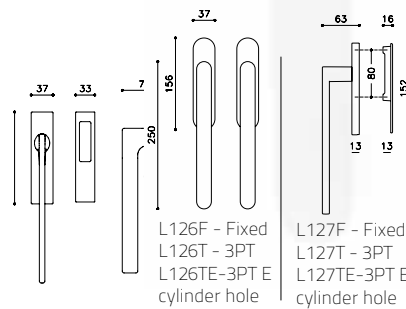
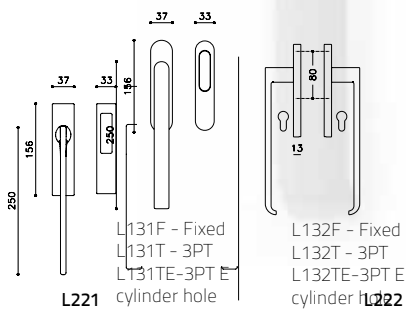

Available Finishes:  
CR, SC  
PBU, EMB, PC, BRZ

Available Finishes:  
CR, SC  
IB, IS, IBN  
IA, ISC, ISBRZ  
PBU, EMB, PC, BRZ

L111 | Planet Studio Olivari  
L112



**NEW**

L113 | Planet Short Studio Olivari  
L114



**NEW**

Available Finish

- CR: Chrome
- SC: Satin Chror

- IB: SuperInox I
- IS: SuperInox S
- INB: SuperInox I Bright (10yw)
- ISB: SuperInox Satin Brass (10yw)
- IA: SuperInox Anthracite (10yw)
- ISC: SuperInox Satin Copper (10yw)
- ISBRZ: SuperInox Satin Bronze (10yw)

- PBU: Polished Brass Unlaquered
- EMB: Electr Matt Black
- BRZ: Dark Wax Bronze
- PC: Powder Coat Colour

- Available Finishes:
- CR, SC
  - IB, IS, IBN, ISN, ISB
  - IA, ISC, ISBRZ
  - PBU, EMB, BRZ, PC

L101 | Polo Studio Olivari  
L102



**NEW**

L103 | Polo Short Studio Olivari  
L104



**NEW**

Available Finis

- CR: Chrome
- SC: Satin Chr

- IB: SuperInox I
- IS: SuperInox S
- INB: SuperInox I Bright (10yw)
- ISB: SuperInox Satin Brass (10yw)
- IA: SuperInox Anthracite (10yw)
- ISC: SuperInox Satin Copper (10yw)
- ISBRZ: SuperInox Satin Bronze (10yw)

- PBU: Polished Brass Unlaquered
- EMB: Electr Matt Black
- BRZ: Dark Wax Bronze
- PC: Powder Coat Colour

- Available Finishes:
- CR, SC
  - IB, IS, IBN, ISN, ISB
  - ISC, ISBRZ
  - PBU, EMB, PC, BRZ

Available Finish

- CR: Chrome
- SC: Satin Chror

- IB: SuperInox I
- IS: SuperInox S
- INB: SuperInox I Bright (10yw)
- ISB: SuperInox Satin Brass (10yw)
- IA: SuperInox Anthracite (10yw)
- ISC: SuperInox Satin Copper (10yw)
- ISBRZ: SuperInox Satin Bronze (10yw)

- PBU: Polished Brass Unlaquered
- EMB: Electr Matt Black
- BRZ: Dark Wax Bronze
- PC: Powder Coat Colour

- Available Finishes:
- CR, SC
  - IB, IS
  - PBU, EMB, PC, BRZ



**Planet Q - P195S**  
 Studio Olivari

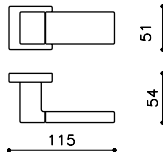

Available Finishes:  
 CR  
 IS, ISN (30yg)  
 PBU, EMB, PC, BRZ

**Bond - P163R**  
 Andrea Branzi 1994

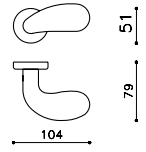

Available Finishes:  
 SC  
 IB (30yg)  
 PBU, EMB, PC, BRZ

**Planet - P195R**  
 Studio Olivari

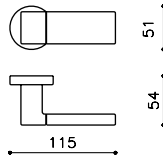

Available Finishes:  
 CR, SC  
 IS, ISN (30yg)  
 PBU, EMB, PC, BRZ

**Blindo - P178R**  
 Studio Olivari 1998

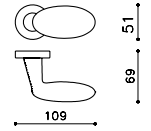

Available Finishes:  
 CR, SC  
 IB, IS, IBN, ISN, ISB (30yg)  
 IA, ISC, ISBRZ (10yg)  
 PBU, EMB, PC, BRZ

**Uovo - P108R**  
 Studio Olivari 1957

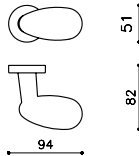

Available Finishes:  
 CR, SC  
 IB, ISB (30yg)  
 ISBRZ (10yg)  
 PBU, EMB, PC, BRZ

**Oscar - P123R**  
 Studio Olivari

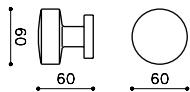

Available Finishes:  
 CR, SC  
 IBN (30yg)  
 ISC, ISBRZ (10yg)  
 PBU, EMB, PC, BRZ

**Link - P200R**  
 Piero Lissoni

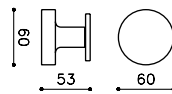

Available Finishes:  
 CR, SC  
 IB, IS, IBN, ISN (30yg)  
 IA, ISC, ISBRZ (10yg)  
 PBU, EMB, PC, BRZ

**Roger - P120R**  
 Studio Olivari

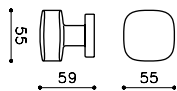

Available Finishes:  
 CR, SC  
 IBN, ISB (30yg)  
 ISC, ISBRZ (10yg)  
 PBU, EMB, PC, BRZ

**Diana - P206S**  
 Studio Olivari

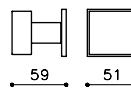

Available Finishes:  
 CR, SC  
 IB, IS, IBN (30yg)  
 IA, ISC, ISBRZ (10yg)  
 PBU, EMB, PC, BRZ

**Edison 60 - P146R**  
 Sergio Mazza and Giuliana Gramigna

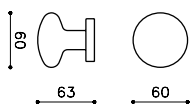

Available Finishes:  
 CR, SC  
 IB, IS, ISB, IBN (30yg)  
 IA, ISC, ISBRZ (10yg)  
 PBU, EMB, PC, BRZ

**Edison 70 - P147R**  
 Sergio Mazza and Giuliana Gramigna

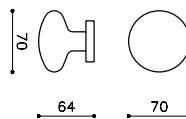

Available Finishes:  
 CR, SC  
 IB, IS, ISB, IBN (30yg)  
 IA, ISC, ISBRZ (10yg)  
 PBU, EMB, PC, BRZ

**Edison 80 - 148R**  
 Sergio Mazza and Giuliana Gramigna

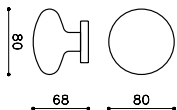

Available Finishes:  
 CR, SC  
 PBU, EMB, BRZ, PC

**Available Finishes Guide:**

- CR: Polished Chrome
- SC: Satin Chrome
- IS: SuperInox Satin Stainless (30yg)
- IB: SuperInox Brass (30yg)
- ISN: SuperInox Satin Nickel (30yg)
- IBN: SuperInox Bright Nickel (30yg)
- ISB: SuperInox Satin Brass (30yg)
- ISC: SuperInox Satin Copper (10yg)
- ISBRZ: SuperInox Satin Bronze (10yg)
- IA: SuperInox Anthracite (10yg)
- PBU: Polished Brass Unlacquered
- EMB: Electro Matt Black
- BRZ: Dark Bronze (waxed)
- PC: Powder Coat

**Link - L199**  
 Piero Lissoni

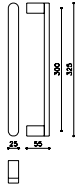

Available Finishes:  
 CR, SC  
 IS, IBN,  
 IA, ISC, ISBRZ  
 PBU, EMB, PC, BRZ

*Specification Code*  
 L199 - Link pull handle single  
 L199BB - Link back to back set

**Diana - L206**  
 Studio Olivari

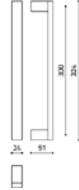

Available Finishes:  
 CR, SC  
 IS, IBN,  
 IA, ISC, ISBRZ  
 PBU, EMB, PC, BRZ

*Specification Code*  
 L206 - Diana pull handle single  
 L206BB - Diana back to back set

**Alexandra - L150**  
 F. A. Porsche

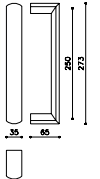

Available Finishes:  
 CR, SC  
 IS,  
 PBU, EMB, PC, BRZ

*Specification Code*  
 L150 - Alexandra pull handle  
 L150BB - Alexandra back to back set

**Planet - L195**  
 Studio Olivari

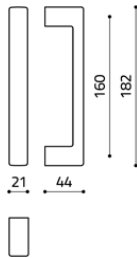

Available Finishes:  
 CR, SC, CRSC  
 IB, IS, IBN, ISN  
 IA, ISC, ISBRZ  
 PBU, EMB, PC, BRZ

*Specification Code*  
 L195 - Planet pull handle single  
 L195BB - Planet back to back set

**Aster - L174R**  
 Studio Olivari

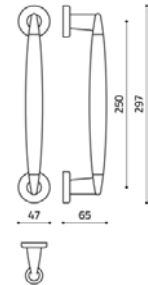

Available Finishes:  
 CRSC  
 IBISB

*Specification Code*  
 L174R - Aster pull handle single  
 on round roses  
 L174RBB - Aster back to back  
 pull handle set on round roses

**Bios - L204 / L205**  
 Franco Sargiani

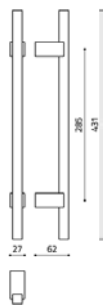

*Specification Code*  
 L204 - Bios pull handle single  
 L204BB - Bios back to back pull  
 handle set

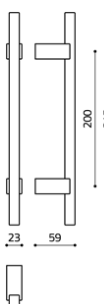

Available Finishes:  
 CR, SC  
 IS, IBN  
 ISC, ISBRZ  
 PBU, EMB, PC, BRZ

*Specification Code*  
 L205 - Bios pull handle single  
 L205BB - Bios back to back set

**Stilo - L189 / L190M / L190L**  
 Enzo Mari

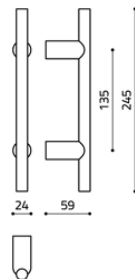

*Specification Code*  
 L189 - Stilo pull handle single  
 L189BB - Stilo back to back pull handle set

Available Finishes:  
 CR, SC  
 IS, IBN  
 ISC, ISBRZ  
 PBU, EMB, PC, BRZ

*Specification Code*  
 L190L - Stilo pull handle  
 single  
 L190LBB - Stilo back to  
 back pull handle set

Available Finishes:  
 CR, SC  
 IS, IBN  
 ISC, ISBRZ  
 PBU, EMB, PC, BRZ

*Specification Code*  
 L190M - Stilo pull handle single  
 L190MBB - Stilo back to back set

Available Finishes:  
 CR, SC, IS, IBN  
 ISC, ISBRZ, PBU, EMB, PC, BRZ

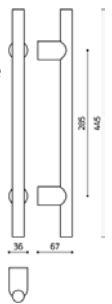

Offset Entry Pulls - Single & Back to Back

**Bond - L163R**  
Andrea Branzi

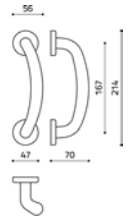

Available Finishes:es  
SC  
PBU, EMB, PC. BRZ

*Specification Code*

L163R - Bond off set pull handle single on round roses  
L163RBB - Bond off set back to back pull handle set on round roses

**Alexandra - L151**  
F. A. Porsche

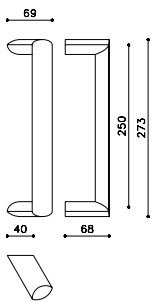

Available Finishes:es  
CR, SC  
IS,  
PBU, EMB, PC. BRZ

*Specification Code*

L151 - Alexandra pull handle single  
L151BB - Alexandra back to back set

**Icaro - L168R**  
Sergio Mazza

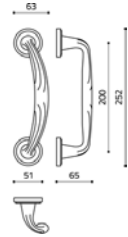

Available Finishes:es  
IB

*Specification Code*

L168R - Icaro pull handle single on round roses  
L168RBB - Icaro back to back pull handle set on round roses

**Stilo - L191M**  
Enzo Mari

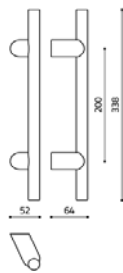

Available Finishes:es  
CR, SC  
IS,  
PBU, EMB, PC. BRZ

*Specification Code*

L191M - Stilo pull handle single  
L191M BB - Stilo back to back set

**Edison - L147R**  
Sergio Mazza

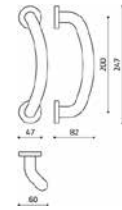

Available Finishes:es  
CR, SC  
IS,  
PBU, EMB, PC. BRZ

*Specification Code*

L147R - Planet pull handle single on round roses  
L147RBB - Planet back to back pull handle set on round roses

**Stilo - L191L**  
Enzo Mari

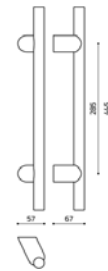

Available Finishes:es  
CR, SC  
IS,  
PBU, EMB, PC. BRZ

*Specification Code*

L191L - Stilo pull handle single  
L191LBB - Stilo back to back set

**Diana - L207**  
Studio Olivari

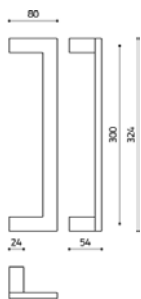

Available Finishes:es  
CR, SC  
IS, IBN  
IA, ISC, ISBRZ  
PBU, EMB, PC. BRZ

*Specification Code*

L207 - Diana off set pull handle single  
L207BB - Diana off set back to back set

**Link - L200**  
Piero Lissoni

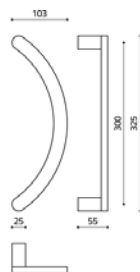

Available Finishes:es  
CR, SC  
IS, IBN  
IA, ISC, ISBRZ  
PBU, EMB, PC. BRZ

*Specification Code*

L200 - Link pull handle single  
L200BB - Link back to back set

**Aster - L175R**  
Studio Olivari

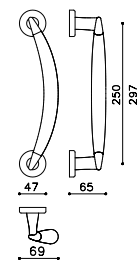

Available Finishes:es  
CRSC  
IBISB

*Specification Code*

L175 - Aster pull handle single  
L175BB - Aster back to back set

**Space Q - H202**  
Studio Olivari

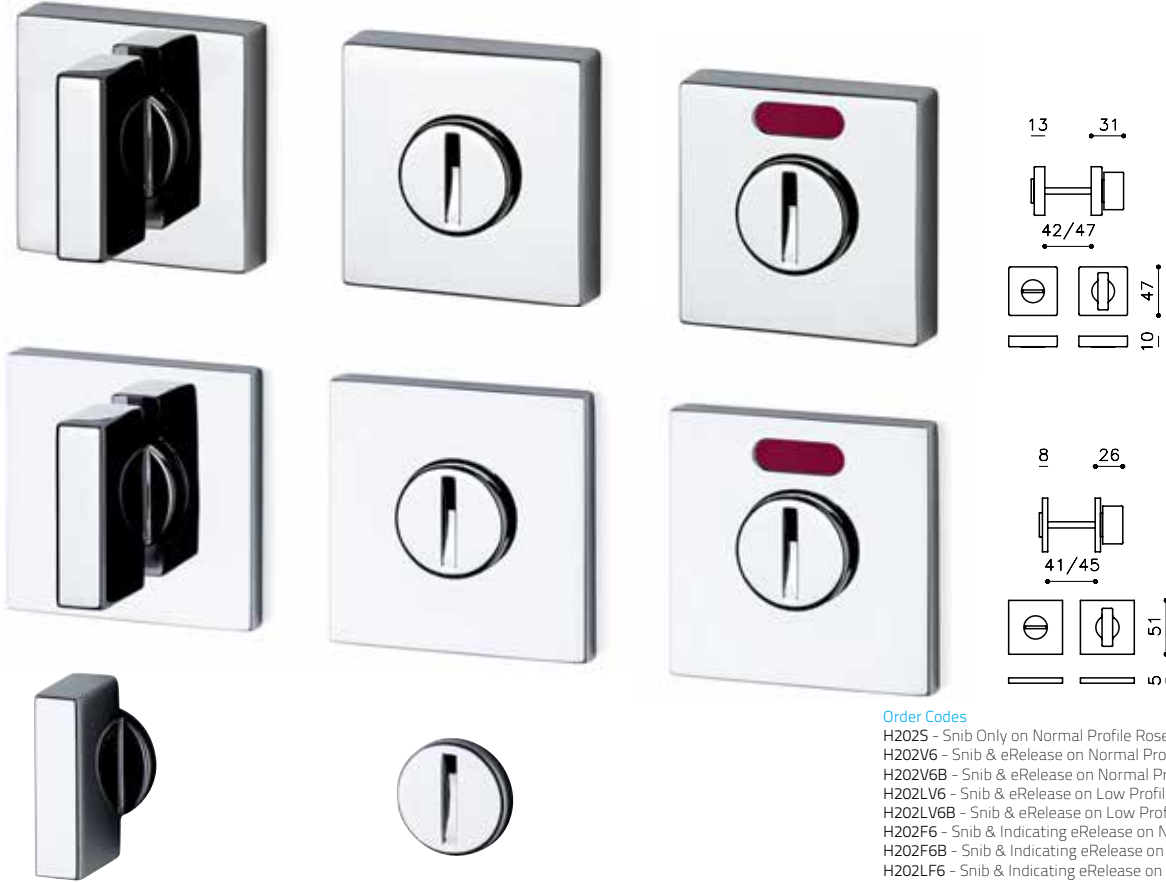

Available Finishes:  
CR, SC  
IB, IS, IBN, ISN, ISB  
IA, ISC, ISBRZ  
PBU, EMB, PC, BRZ

- Order Codes**
- H2025 - Snib Only on Normal Profile Rose to suit Australian style locks
  - H202V6 - Snib & eRelease on Normal Profile Rose
  - H202V6B - Snib & eRelease on Normal Profile Rose with Throw Bolt
  - H202LV6 - Snib & eRelease on Low Profile Rose
  - H202LV6B - Snib & eRelease on Low Profile Rose with Throw Bolt
  - H202F6 - Snib & Indicating eRelease on Normal Profile Rose
  - H202F6B - Snib & Indicating eRelease on Normal Profile Rose with Throw Bolt
  - H202LF6 - Snib & Indicating eRelease on Low Profile Rose
  - H202LF6B - Snib & Indicating eRelease on Low Profile Rose with Throw Bolt
  - H202B6 - Snib & eRelease, No Rose
  - H202B6B - Snib & eRelease No Rose with Throw Bolt

**Cubo - H136**  
Studio Olivari



Available Finishes:  
CR, SC  
IB, IS, IBN, ISN, ISB  
IA, ISC, ISBRZ  
PBU, EMB, PC, BRZ

- Order Codes**
- H1365 - Snib Only on Normal Profile Rose to suit Australian style locks
  - H136V6 - Snib & eRelease on Normal Profile Rose
  - H136V6B - Snib & eRelease on Normal Profile Rose with Throw Bolt
  - H136LV6 - Snib & eRelease on Low Profile Rose
  - H136LV6B - Snib & eRelease on Low Profile Rose with Throw Bolt
  - H136F6 - Snib & Indicating eRelease on Normal Profile Rose
  - H136F6B - Snib & Indicating eRelease on Normal Profile Rose with Throw Bolt
  - H136LF6 - Snib & Indicating eRelease on Low Profile Rose
  - H136LF6B - Snib & Indicating eRelease on Low Profile Rose with Throw Bolt
  - H136B6 - Snib & eRelease, No Rose
  - H136B6B - Snib & eRelease No Rose with Throw Bolt

**Link - H200**  
Piero Lissoni

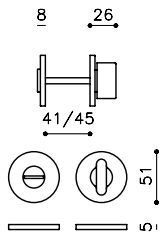
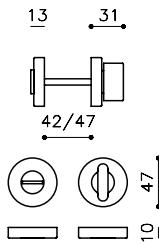

Available Finishes:  
CR, SC

IB, IS, IBN, ISN, ISB

IA, ISC, ISBRZ

PBU, EMB, PC, BRZ

Order Codes

H200S - Snib Only on Normal Profile Rose to suit Australian style locks

H200V6 - Snib & eRelease on Normal Profile Rose

H200V6B - Snib & eRelease on Normal Profile Rose with Throw Bolt

H200LV6 - Snib & eRelease on Low Profile Rose

H200LV6B - Snib & eRelease on Low Profile Rose with Throw Bolt

H200F6 - Snib & Indicating eRelease on Normal Profile Rose

H200F6B - Snib & Indicating eRelease on Normal Profile Rose with Throw Bolt

H200LF6 - Snib & Indicating eRelease on Low Profile Rose

H200LF6B - Snib & Indicating eRelease on Low Profile Rose with Throw Bolt

H200B6 - Snib & eRelease, No Rose

H200B6B - Snib & eRelease No Rose with Throw Bolt

**Verona - H107**

Studio Olivari

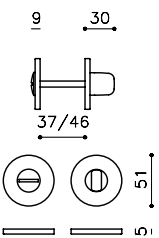
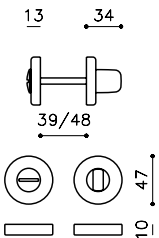

Available Finishes:  
CR, SC

IB, IS, IBN, ISN, ISB

IA, ISC, ISBRZ

PBU, EMB, PC, BRZ

Order Codes

H107S - Snib Only on Normal Profile Rose to suit Australian style locks

H107V6 - Snib & eRelease on Normal Profile Rose

H107V6B - Snib & eRelease on Normal Profile Rose with Throw Bolt

H107LV6 - Snib & eRelease on Low Profile Rose

H107LV6B - Snib & eRelease on Low Profile Rose with Throw Bolt

H107F6 - Snib & Indicating eRelease on Normal Profile Rose

H107F6B - Snib & Indicating eRelease on Normal Profile Rose with Throw Bolt

H107LF6 - Snib & Indicating eRelease on Low Profile Rose

H107LF6B - Snib & Indicating eRelease on Low Profile Rose with Throw Bolt

H107B6 - Snib & eRelease, No Rose

H107B6B - Snib & eRelease No Rose with Throw Bolt



Lever on 1224 Plate

Available Finishes:  
CR, SC  
IB, IS, IBN, ISN, ISB  
IA, ISC, ISBRZ  
PBU, EMB, PC, BRZ

1224 Olivari Back plate  
Size: 234 x 40 x 10mm  
Suitability: Timber Doors  
with Euro Locks



Lever on 1227 Plate

Available Finishes:  
CR, SC  
IS, IB  
PBU, EMB, PC, BRZ

1227 Narrow Back plate  
Size: 185 x 25 x 12mm  
Suitability: Timber / Aluminium  
Doors with Aust Locks



Lever on 1228 Plate

Available Finishes:  
CR, SC  
IS, IB  
PBU, EMB, PC, BRZ

1228 Narrow Backplate  
Size: 220 x 25 x 12mm  
Suitability: Timber / Aluminium  
Doors with Euro Locks

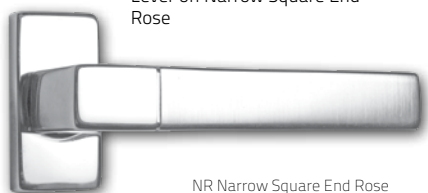

Lever on Narrow Square End Rose

NR Narrow Square End Rose  
Size: 60 x 30 x 10mm  
Suitability: Timber / Aluminium Doors  
Doors with Euro Locks

Available Finish  
CR, SC  
IB, IS, IBN, ISN, ISB  
IA, ISC, ISBRZ  
PBU, EMB, PC, BRZ

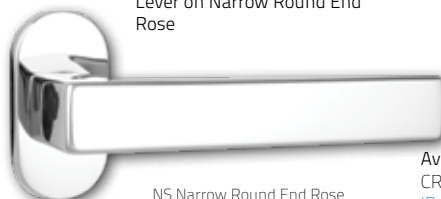

Lever on Narrow Round End Rose

NS Narrow Round End Rose  
Size: 60 x 30 x 10mm  
Suitability: Timber / Aluminium Doors  
Doors with Euro Locks

Available Finish  
CR, SC  
IB, IS, IBN, ISN, ISB  
IA, ISC, ISBRZ  
PBU, EMB, PC, BRZ

Olivari Cylinder Escutcheons - Used on Timber, Glass and Aluminium Framed Doors

European Style Cylinder Escutcheons

Round

1191LE & 1191E

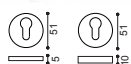

Alexandra

1177E



Oval

1155LE & 1155E

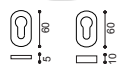

Square

1192LE & 1192E

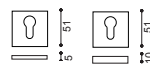

Rectangle

1197LE & 1197E

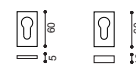

Australian Style Cylinder Escutcheons

Round

1191LO & 1191O

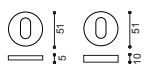

Alexandra

1177O



Oval

1155LO & 1155O

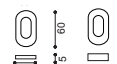

Square

1192LO & 1192O

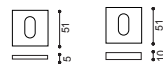

Rectangle

1197LO & 1197O



Alexandra - H150V6

F. A. Porsche



Order Codes  
H150V6 - Snib & eRelease  
H150V6B - Snib & eRelease with throw bolt  
Specially designed to suit the Alexandra lever by F. A. Porsche

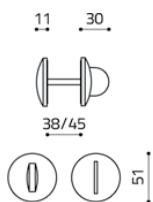

Available Finishes:

CR: Polished Chrome  
SC: Satin Chrome

IS: Superinox Satin Stainless (30yg)

PBU: Polished Brass Unlacquered  
EMB: Electro Matt Black  
PC: Powder Coat  
BRZ: Dark Bronze (Waxed)

Privacy button on Rose

Studio Olivari

Custom Item

Available on both Round & Square Rose

Available Finishes:

CR, SC, IS, IB



## D111 | Siro Flush Pull

Olivari of Italy

**Door Suitability:**

timber & aluminium doors

**Available Finishes:**

CR, SC

IB, IS, IBN, ISN, ISB

IA, ISC, ISBRZ

PBU

**Specification Codes:**

D111 - Finish

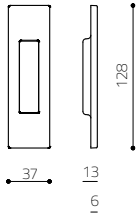

*Suitable for timber & aluminium doors*

## D109 | Vico Flush Pull

Olivari of Italy

**Door Suitability:**

timber & aluminium doors

**Available Finishes:**

CR, SC

IB, IS, IBN, ISN, ISB

IA, ISC, ISBRZ

PBU

**Specification Codes:**

D109 - Finish

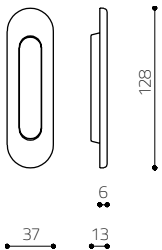

*Suitable for timber & aluminium doors*

## D509 | Nemi Flush Pull

Olivari of Italy

**Door Suitability:**

timber & aluminium doors

**Available Finishes:**

BL, WH (nylon)

**Specification Codes:**

D509 - Finish

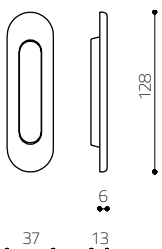



# D129 | Giotto Q Flush Pull

Olivari of Italy

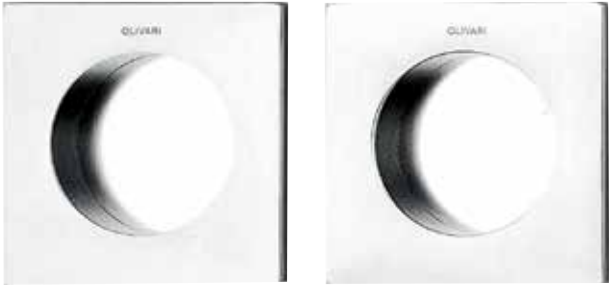

**Door Suitability:**  
timber & aluminium doors

**Available Finishes:**  
CR, SC  
IB, IS, IBN, ISN, ISB  
IA, ISC, ISBRZ  
PBU

**Specification Codes:**  
D129 - Finish

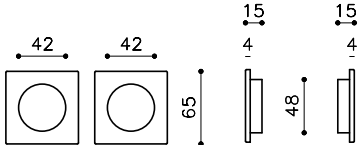

Suitable for timber & aluminium doors

# D134 | Dante Flush Pull

Olivari of Italy



**Door Suitability:**  
timber & aluminium doors

**Available Finishes:**  
CR, SC  
IB, IS, IBN, ISN, ISB  
IA, ISC, ISBRZ  
PBU

**Specification Codes:**  
D134 - Finish

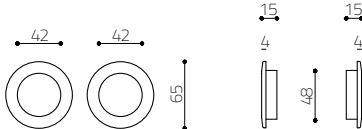

Suitable for timber & aluminium doors

# D126 | Sliding Door Finger Pull

Olivari of Italy



**Door Suitability:**  
timber & aluminium doors

**Available Finishes:**  
CR, SC  
IB, IS, IBN, ISN, ISB  
IA, ISC, ISBRZ  
PBU, EMB, BRZ, PC

**Specification Codes:**  
D126 - Finish

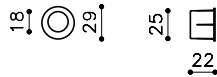

Suitable for timber & aluminium doors

## K13250L | Privacy Flush Pull

Didheya of Spain

**Door Suitability:**

Door Thickness: 32mm +  
timber doors only

**Available Finishes:**

SS satin stainless steel  
PS polished stainless steel (face only)  
PC powder coat

**Specification Codes:**

K13250L - Finish  
Includes sliding door latch

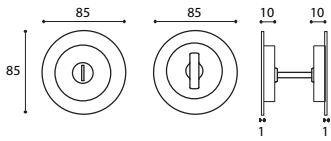
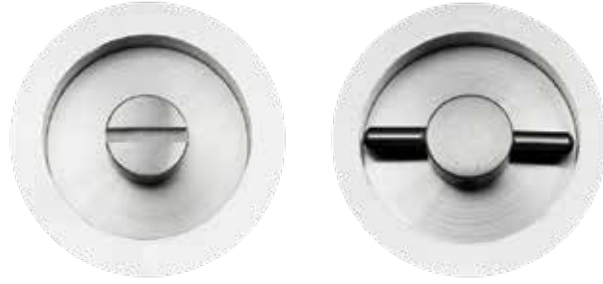

## D132L | Dante Privacy Flush Pull

Olivari of Italy

**Door Suitability:**

Door Thickness: 40mm +  
timber & aluminium doors

**Available Finishes:**

CR, SC  
IB, IS, IBN, ISN, ISB  
IA, ISC, ISBRZ  
PBU

**Specification Codes:**

D132L - Finish  
Includes sliding door latch

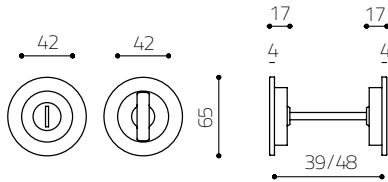

*Suitable for timber & aluminium doors*

## D133L | Dante Privacy Flush Pull

Olivari of Italy

**Door Suitability:**

Door Thickness: 40mm +  
timber & aluminium doors

**Available Finishes:**

CR, SC  
IB, IS, IBN, ISN, ISB  
IA, ISC, ISBRZ  
PBU

**Specification Codes:**

D133L - Finish  
Includes sliding door latch

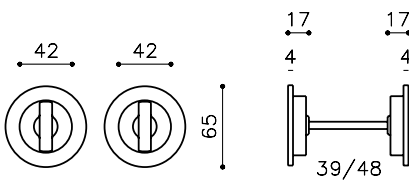

*Suitable for timber & aluminium doors*

## K14250L | Privacy Flush Pull

Didheya of Spain



**Door Suitability:**

Door Thickness: 32mm +  
timber doors only

**Available Finishes:**

SS satin stainless steel  
PS polished stainless steel (face only)  
PC powder coat

**Specification Codes:**

K14250L - Finish  
Includes sliding door latch

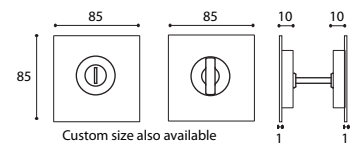

## D127L | Giotto Q Privacy Flush Pull

Olivari of Italy



**Door Suitability:**

Door Thickness: 40mm +  
timber & aluminium doors

**Available Finishes:**

CR, SC  
IB, IS, IBN, ISN, ISB  
IA, ISC, ISBRZ  
PBU

**Specification Codes:**

D127L - Finish  
Includes sliding door latch

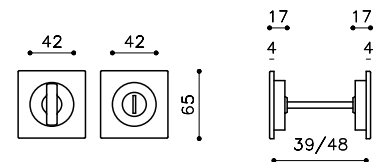

*Suitable for timber & aluminium doors*

## D128L | Giotto Q Privacy Flush Pull

Olivari of Italy



**Door Suitability:**

Door Thickness: 40mm +  
timber & aluminium doors

**Available Finishes:**

CR, SC  
IB, IS, IBN, ISN, ISB  
IA, ISC, ISBRZ  
PBU

**Specification Codes:**

D128L - Finish  
Includes sliding door latch

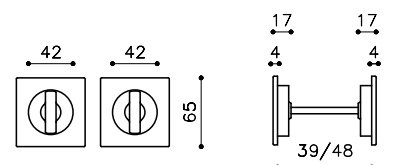

*Suitable for timber & aluminium doors*

## B136 | Cubo Floor Mounted Door Stop

Olivari of Italy

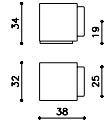

Olivari Cubo - B136M  
Magnetic Door Stop

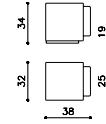

Olivari Cubo - B136N  
Non Magnetic Door Stop

Available Finishes:  
CR, SC  
IB, IS, IBN, ISN, ISB  
IA, ISC, ISBRZ  
PBU, EMB, BRZ, PC

## B106 | Victor Floor Mounted Door Stop

Olivari of Italy

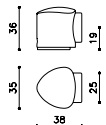

Olivari Victor - B106M  
Magnetic Door Stop

Available Finishes:  
CR, SC  
IB, IS, IBN, ISN, ISB  
IA, ISC, ISBRZ  
PBU, EMB, BRZ, PC

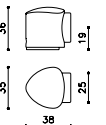

Olivari Victor - B106N  
Non Magnetic Door Stop

Available Finishes:  
CR, SC  
IB, IS, IBN, ISN, ISB  
IA, ISC, ISBRZ  
PBU, EMB, BRZ, PC

## Floor Mounted Door Stops

Olivari of Italy



Olivari Gardena - B103

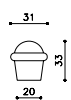

Available Finishes:  
IB  
PBU, EMB, BRZ, PC



Olivari Sector - B101



Available Finishes:  
CR, SC  
IB, IS, IBN, ISN, ISB  
ISC, ISBRZ  
PBU, EMB, BRZ, PC



Olivari Raffaella - B102

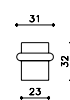

Available Finishes:  
CR, SC  
IB, IS, IBN, ISN, ISB  
IA, ISC, ISBRZ  
PBU, EMB, BRZ, PC

## Floor Mounted Door Stop

Olivari of Italy



Olivari Stilo - B121



Available Finishes:  
CR, SC  
IB  
PBU, EMB, BRZ, PC



Olivari Stilo - B123R

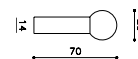

Available Finishes:  
CR, SC  
IB  
PBU, EMB, BRZ, PC

## Wall Mounted Door Stop

Olivari of Italy

# G2401

**Base Material**  
Aluminium

**Available Finishes:**  
Blast Anodised Silver & Anodised Silver (S)  
Blast Anodised Black & Anodised Black (B)

**Available Sizes (mm)**  
Length 455, Centres 425

**Fixing Holes Sizes**  
Door 10mm, Glass 16mm

**Specification Code**  
G2401 - 455 - finish



Bellevue Architectural  
954 Glenhuntly Road, Caulfield South, Victoria, Australia, 3162

Call Us Or Visit Our Web Site For Your Nearest Display Centre.

Phone: +61 (0)3 9571 5666

Web: [www.bellevuearch.com.au](http://www.bellevuearch.com.au)

Fax: +61 (0)3 9571 1347

eMail: [info@bellevuearch.com.au](mailto:info@bellevuearch.com.au)

Retail Olivari: Catalogue V2/18

The catalogue and products may be updated. Registered trademarks and patented designs. All rights reserved © Olivari B. s.p.a. & Bellevue Imports P/L  
Bellevue Imports P/L trading as Bellevue Architectural